



**SKY**  
AGRICULTURE

**PROGRESS TF**

**SKY**  
AGRICULTURE



**SKY**  
AGRICULTURE

**PROGRESS TF**





Fontenay-sur-Eure



Châteaubourg



La Conillais



Osasco









**WE ARE** energetic  
PRECISION **ARE** efficiency  
**INDUSTRIAL**  
TECHNOLOGY

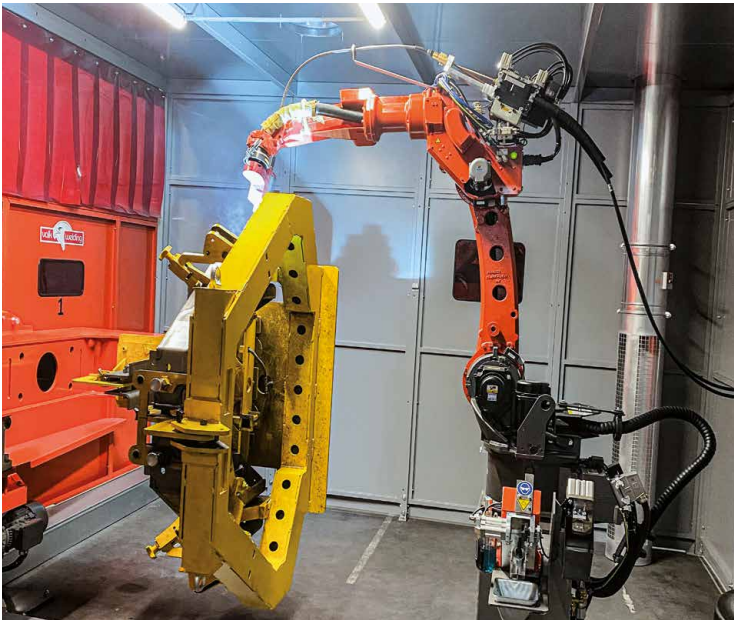





# FARMING TOGETHER

Be positive about Agriculture

*Positivez sur l'Agriculture*

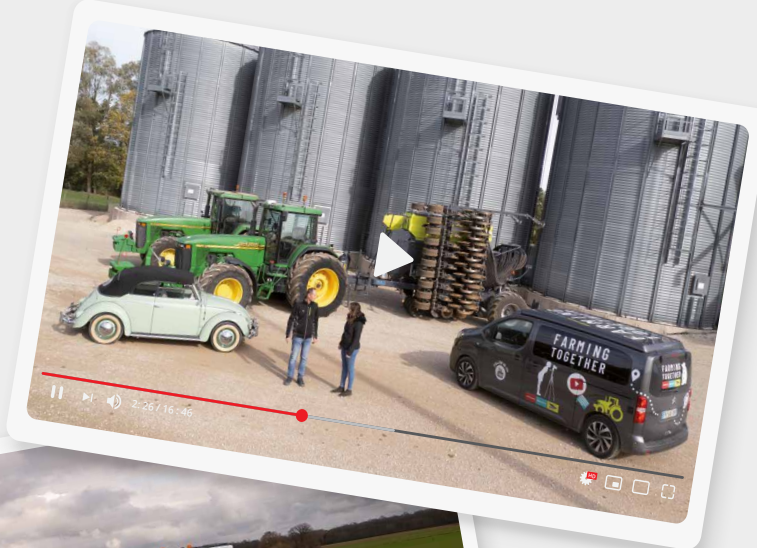



# FARMING TOGETHER

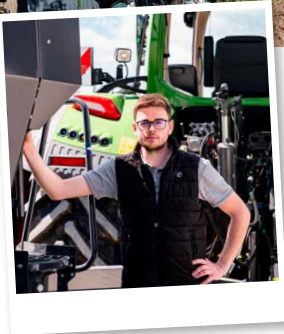

50€

+

50€

+

50€

=

150€

Progress TF

HR

LS

[farming-together.com](http://farming-together.com)





1936 - Super Sulky









## HR



**HR 190 / 3m**



**HR 220 / 3,5 - 4m**



**HR 300 / 3 - 3,5 - 4m**



**HRW 280 / 4 - 4,5 - 5 - 6m**



**HRW 360 / 6 - 7 - 8m**

## Rolls



**Cage Ø500 mm**



**Farmflex Ø520 mm**



**Packer Ø550 mm**



**Tracker Ø550 mm**

## Seeding line



**P20**



**P30**



**P50**



**P100**



# Hoppers





1

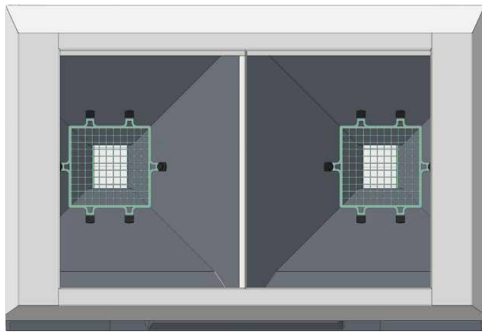

1 100L      1 100L

✓ **2 200L**

2

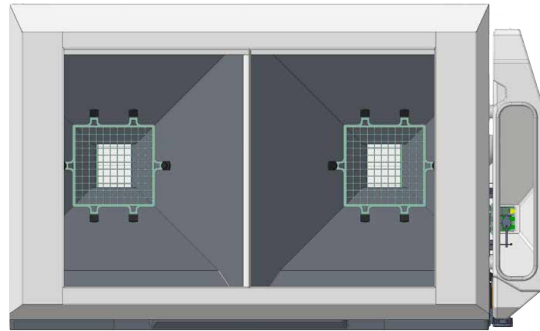

1 100L      1 100L      100L

✓ **2 300L**

3

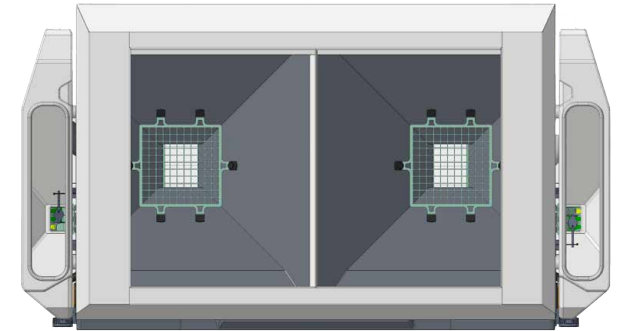

100L      1 100L      1 100L      100L

✓ **2 400L**





PROGRESS TF



x2

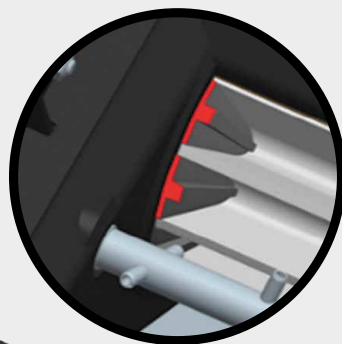

**0,5**  
kg / ha



**450**  
kg / ha









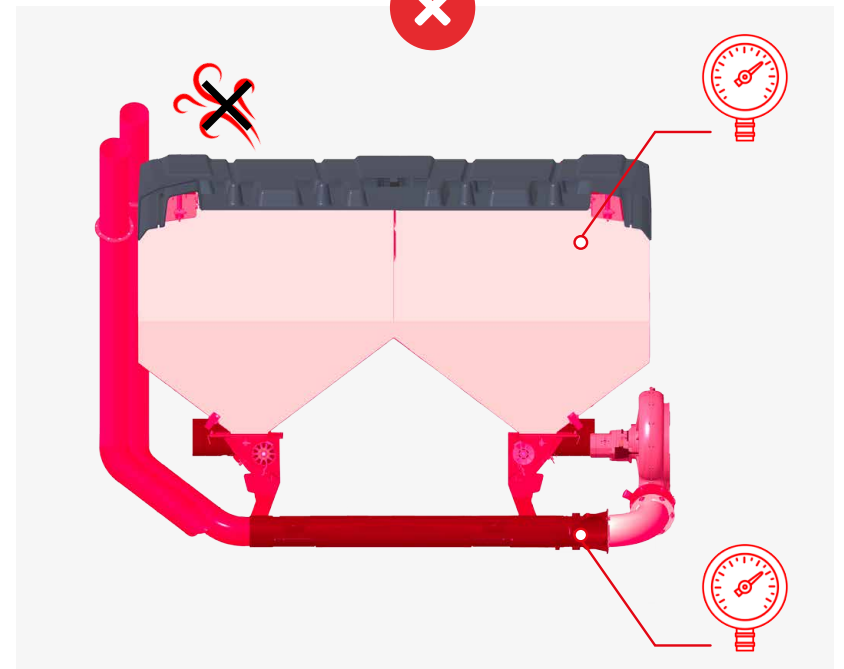
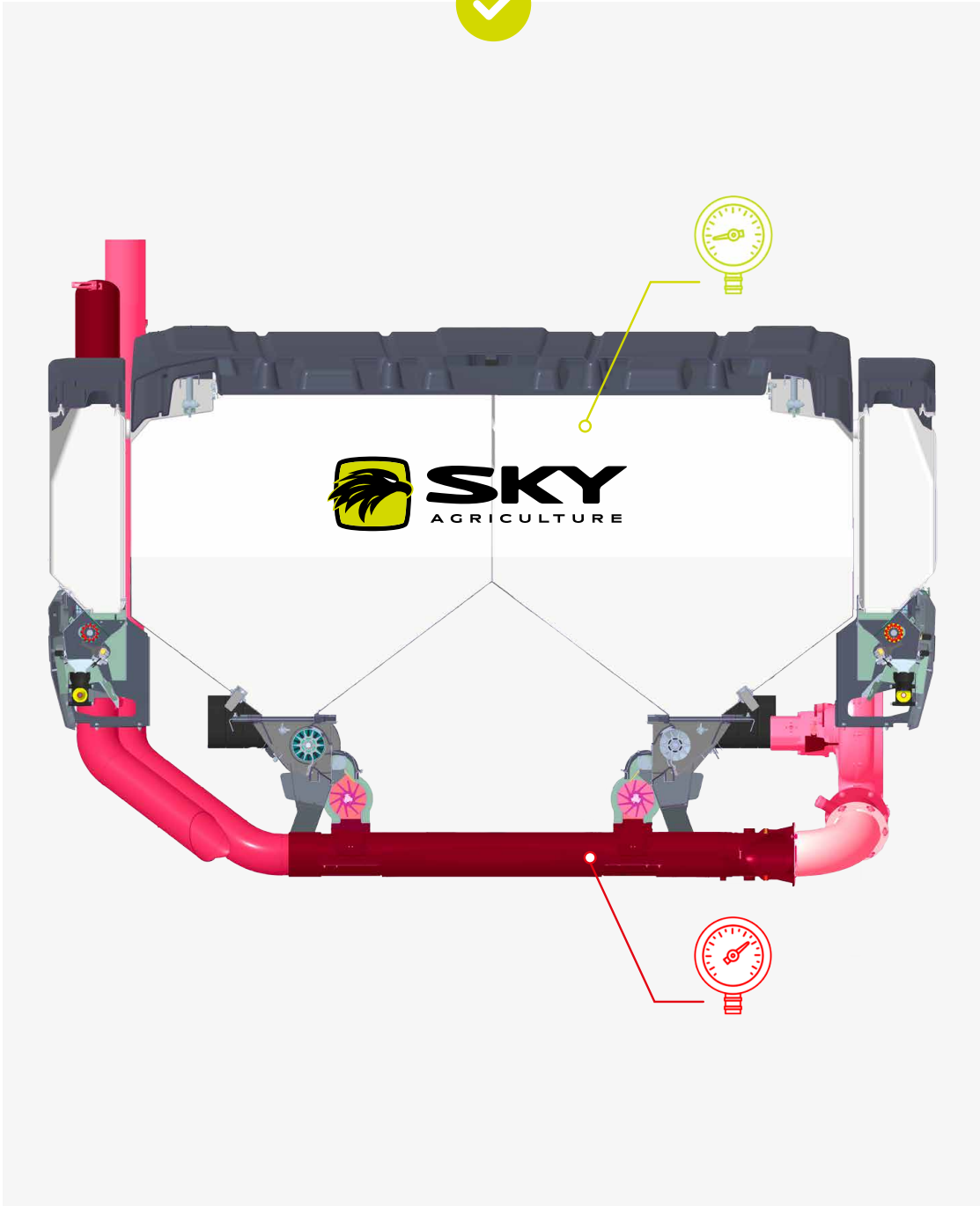





GRESS

**SKY**  
AGRICULTURE

6R  
AGREOM

250

JOHN DEERE



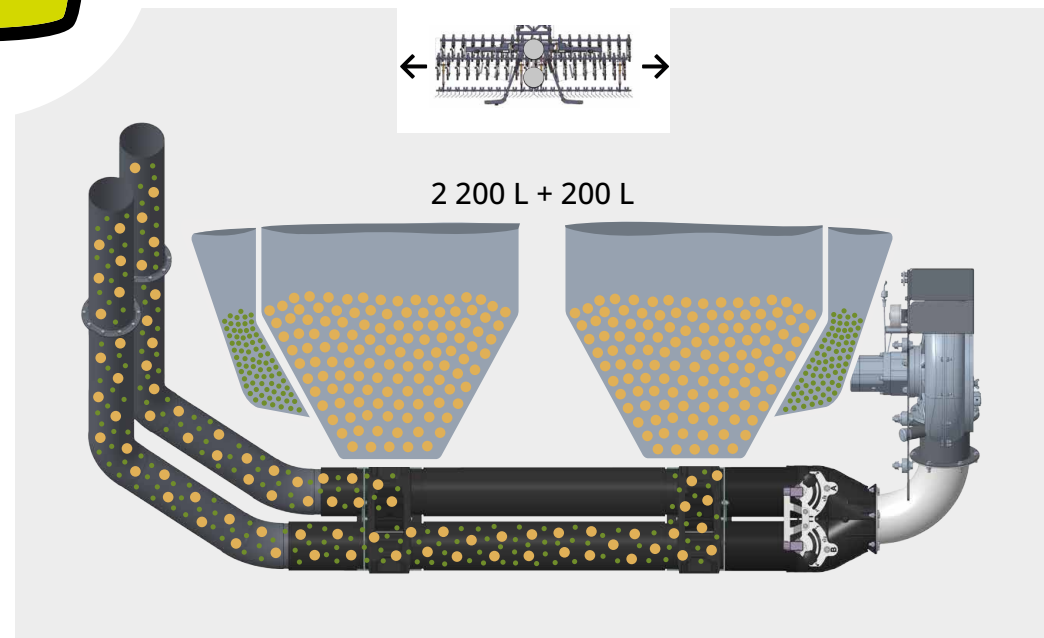
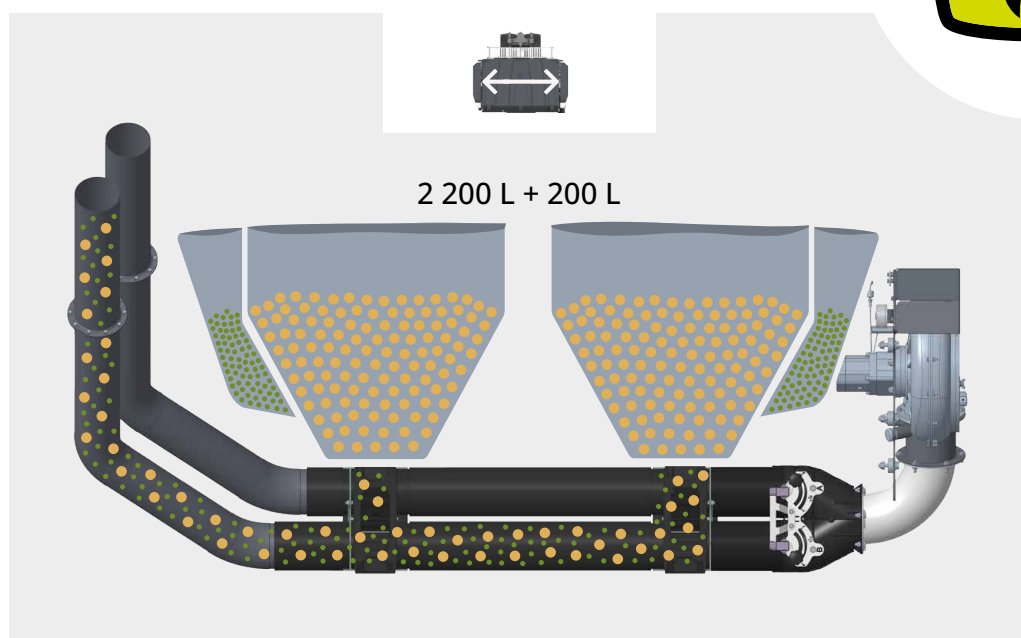
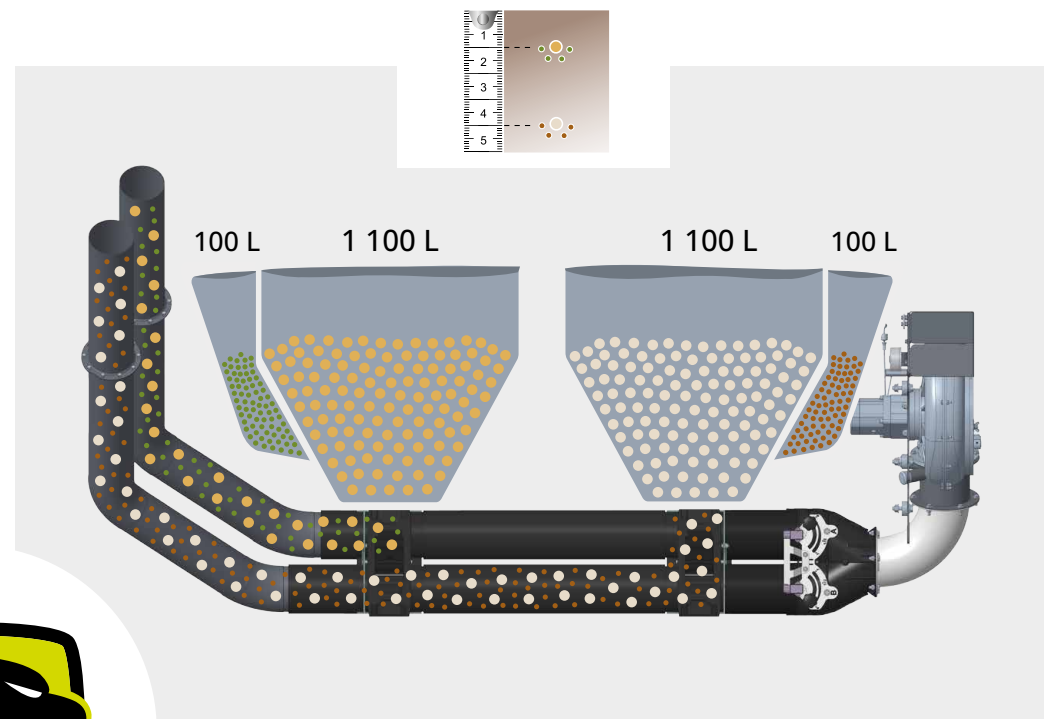
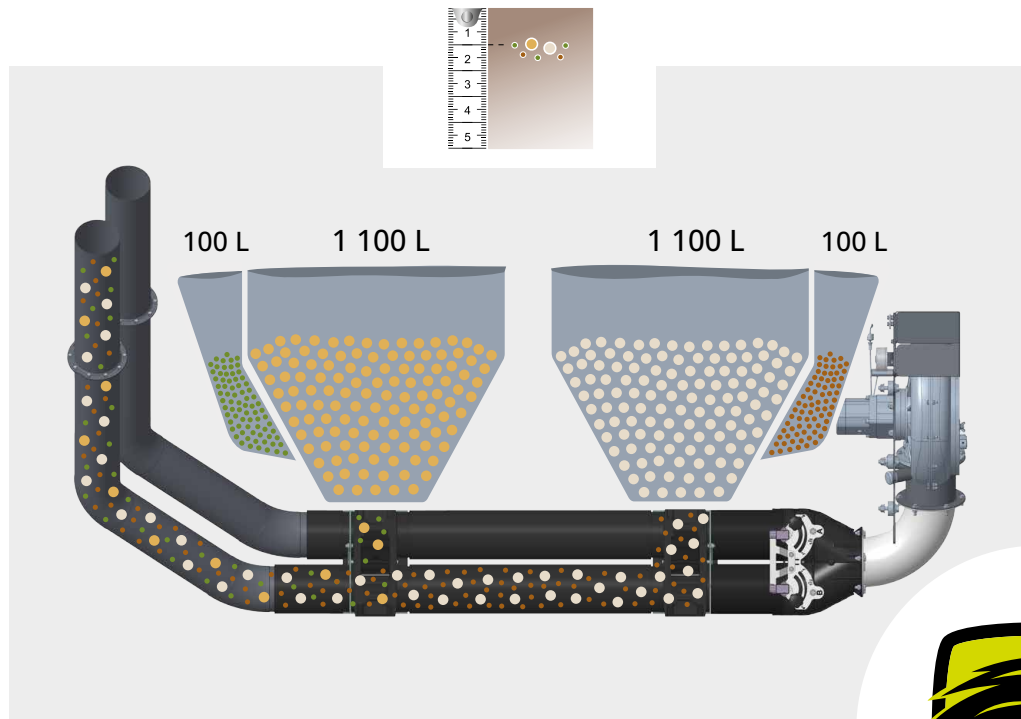

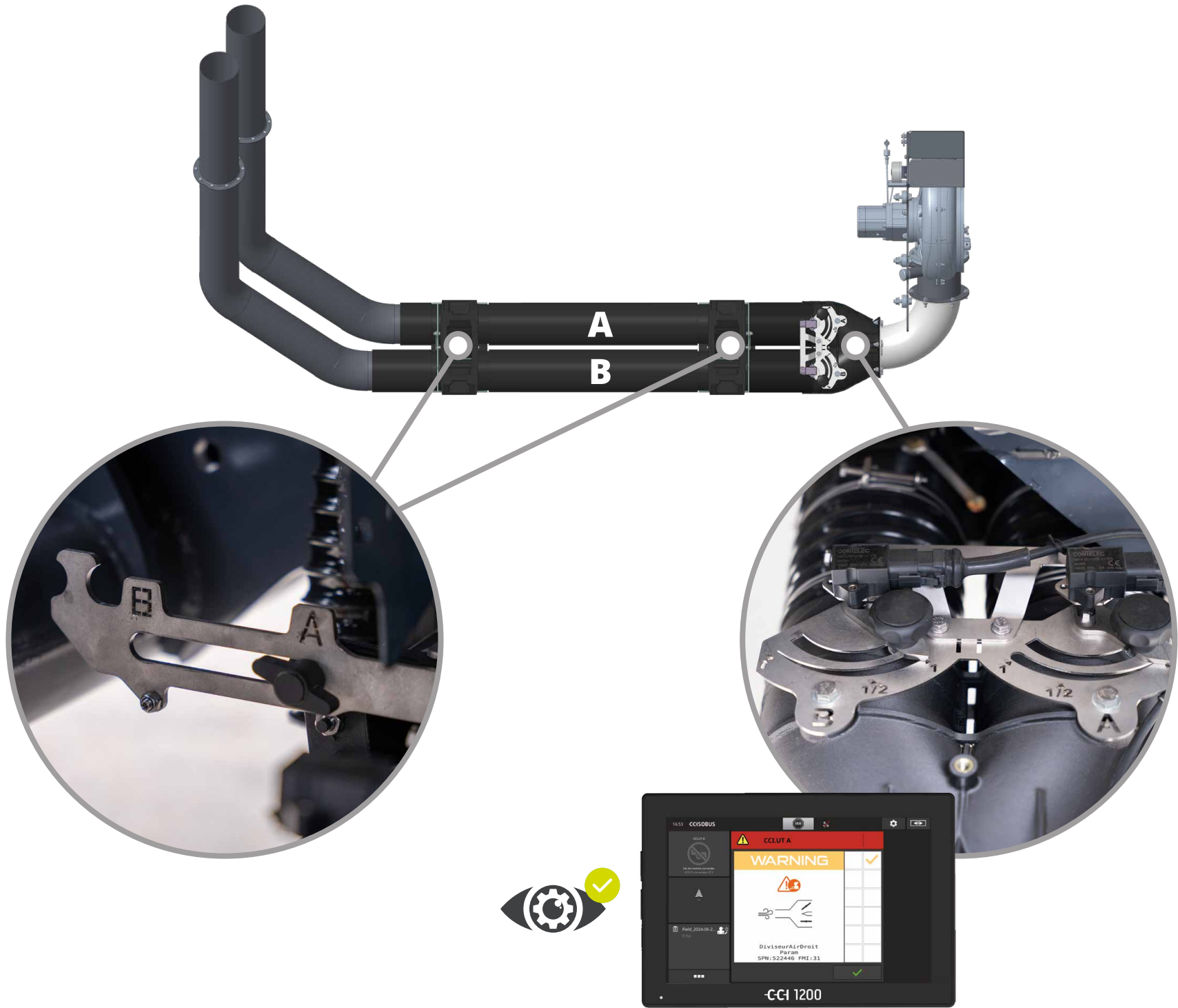



# E-Drive

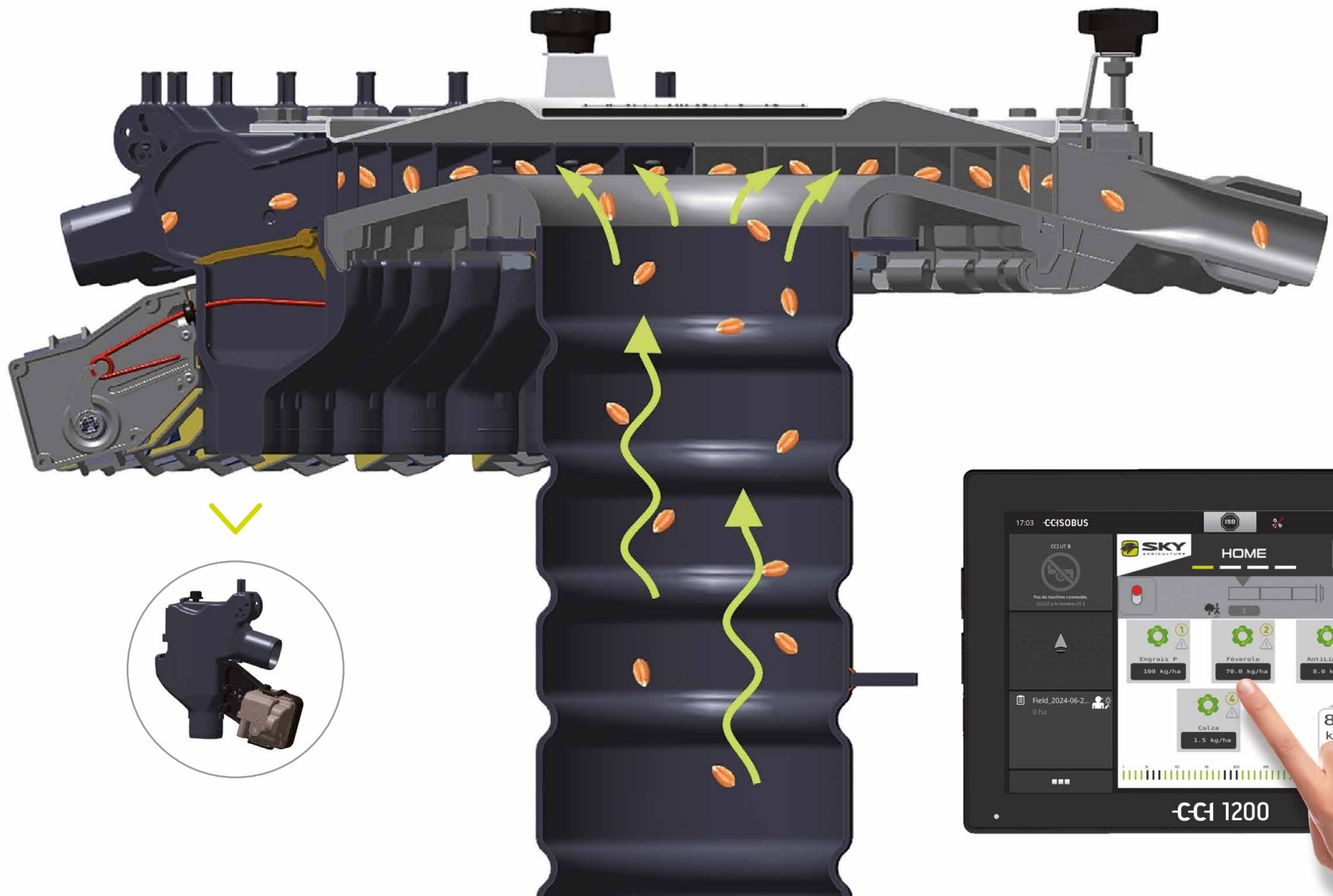

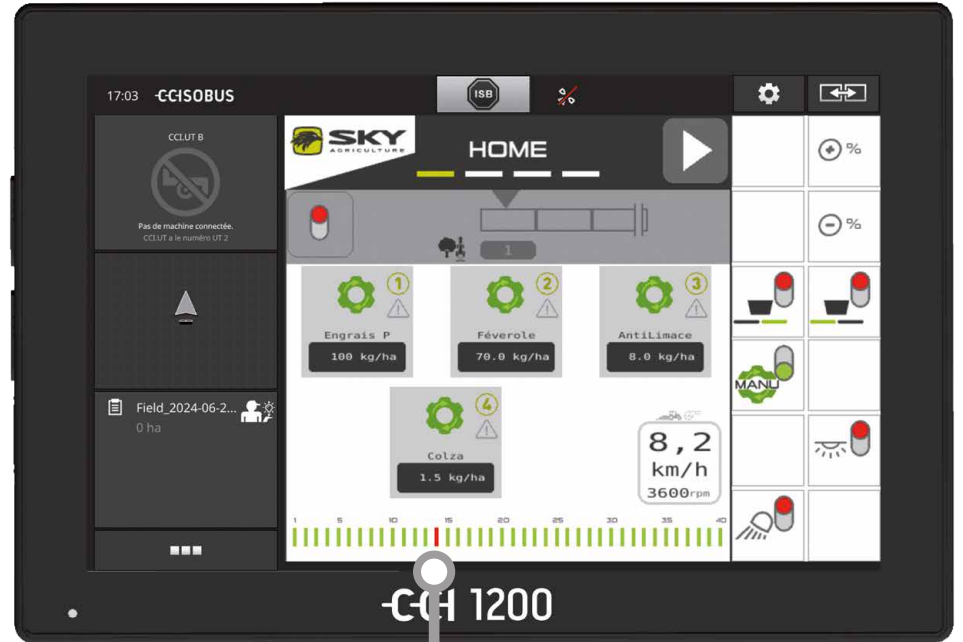

=





# E-Drive

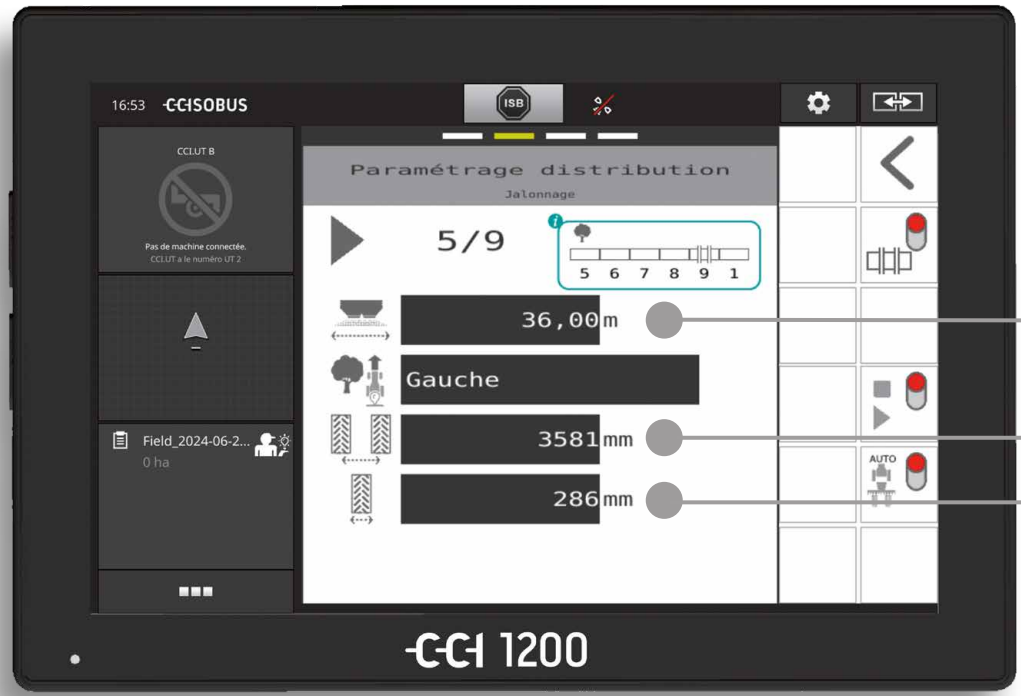
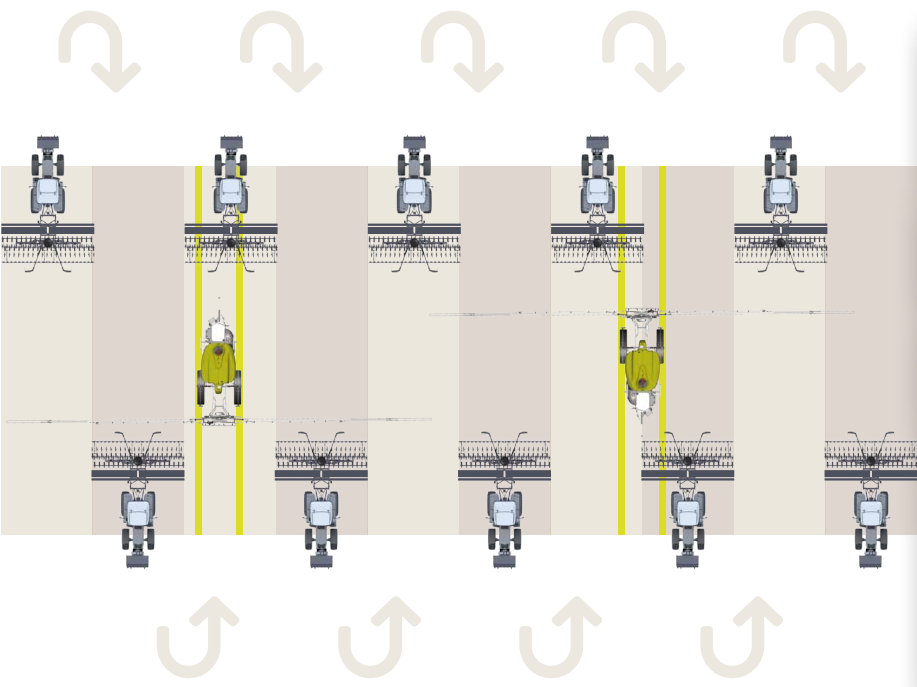

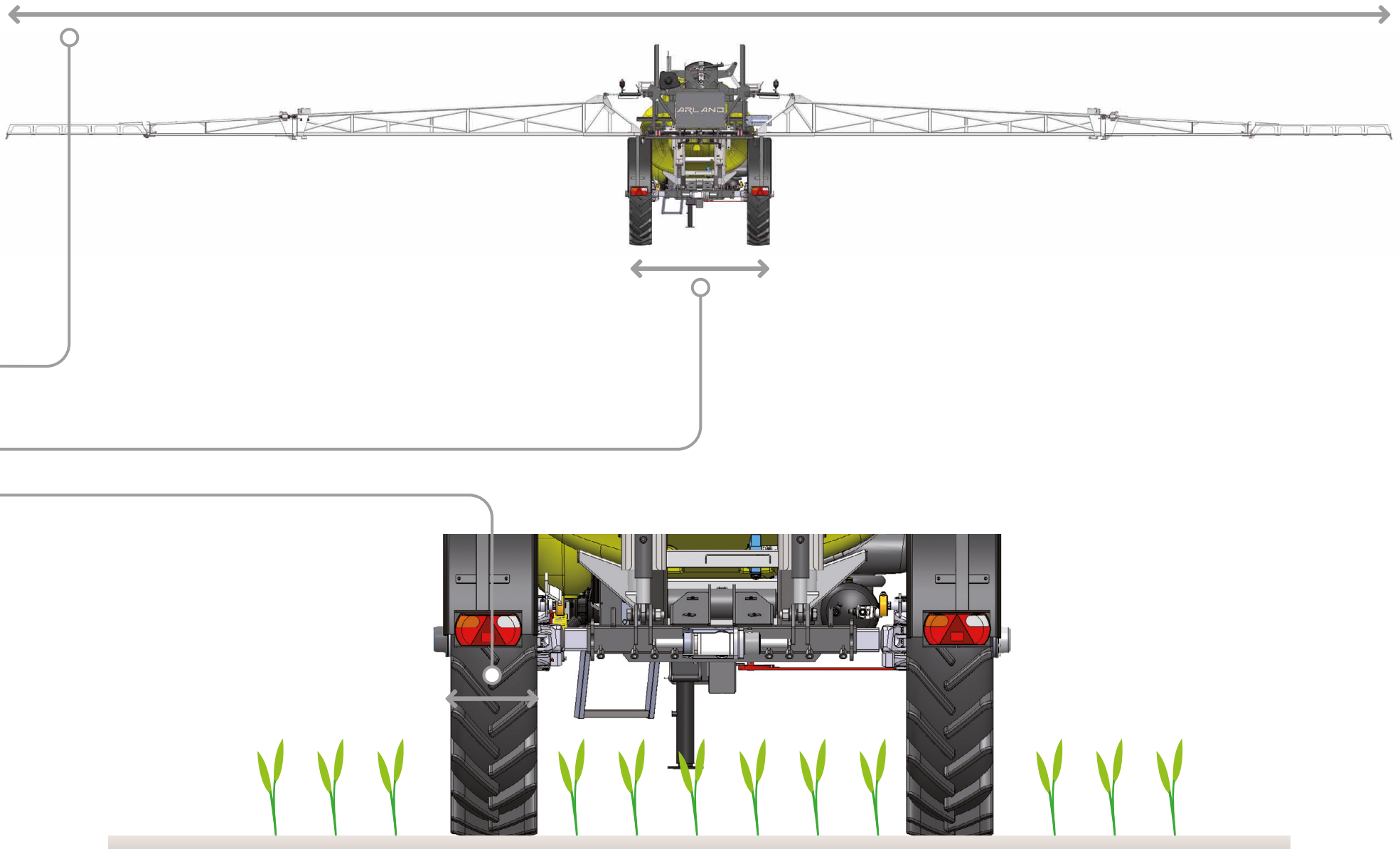



# E-Drive

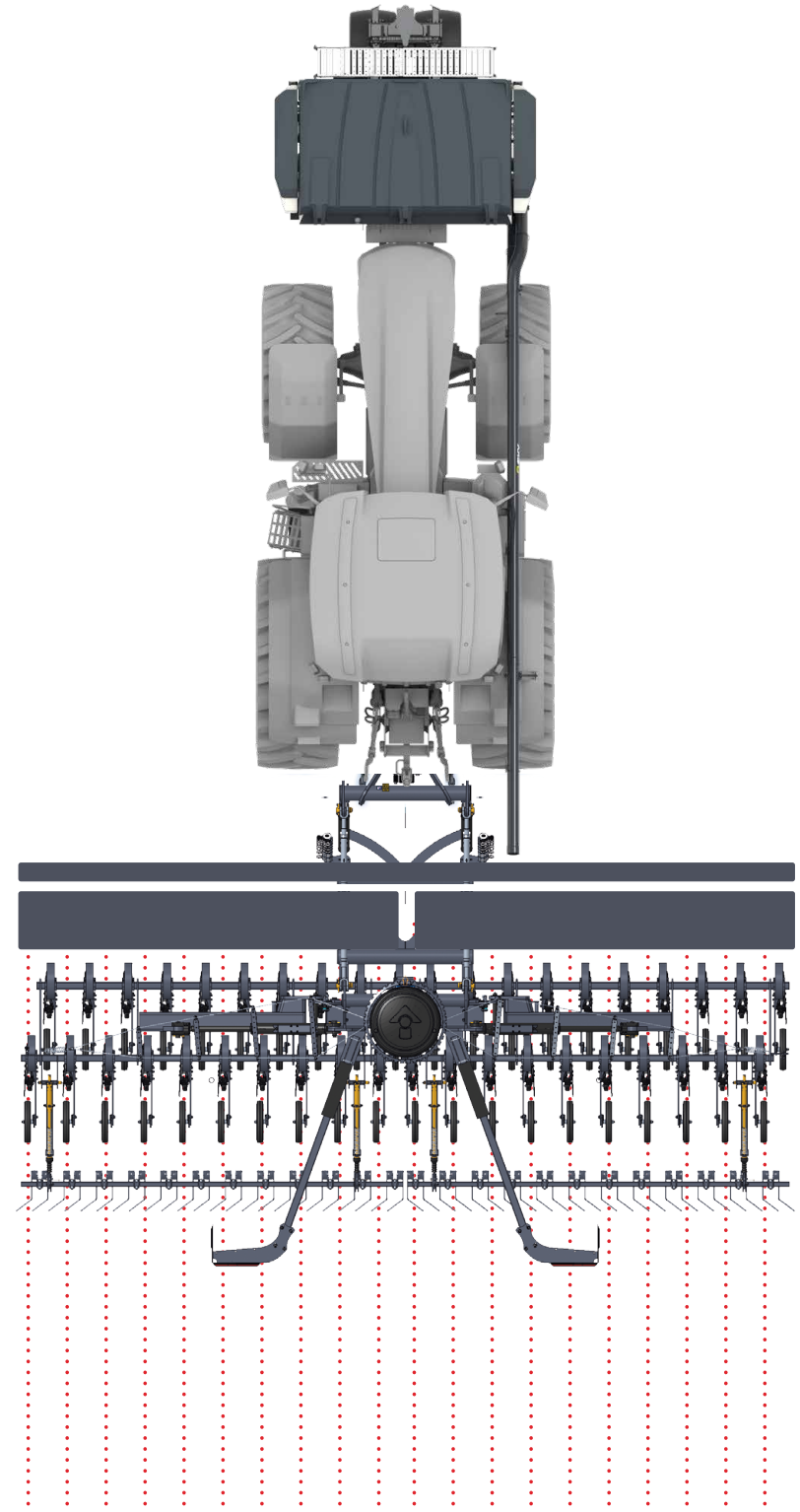



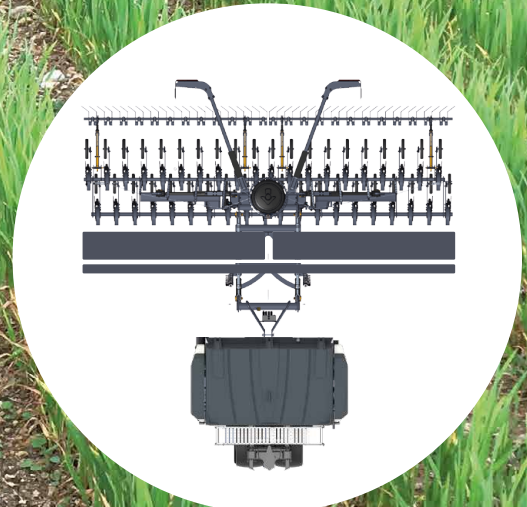
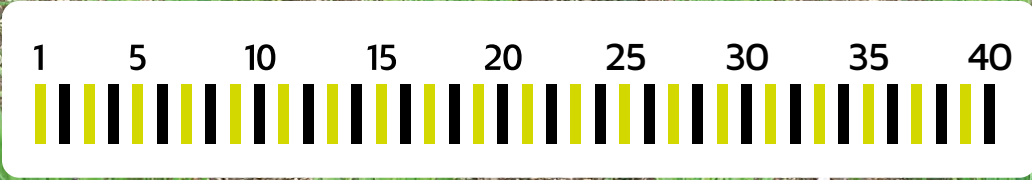
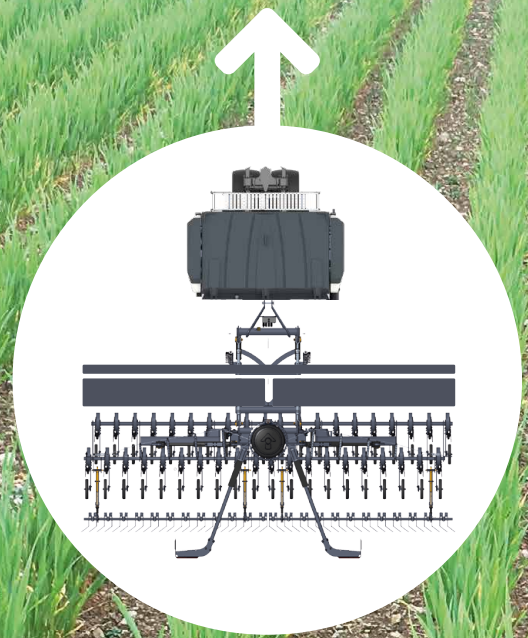



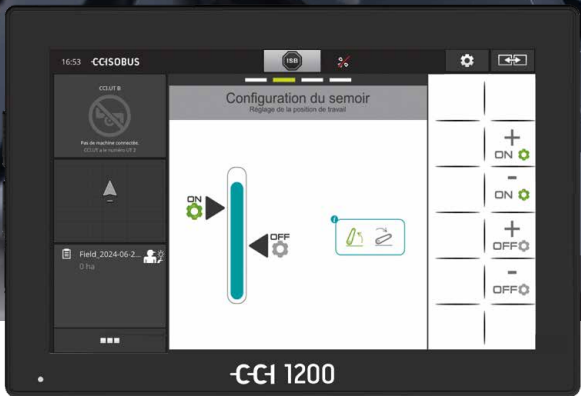

**Stop**

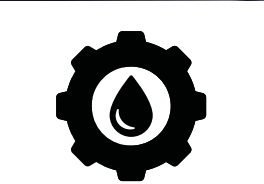

# & Go

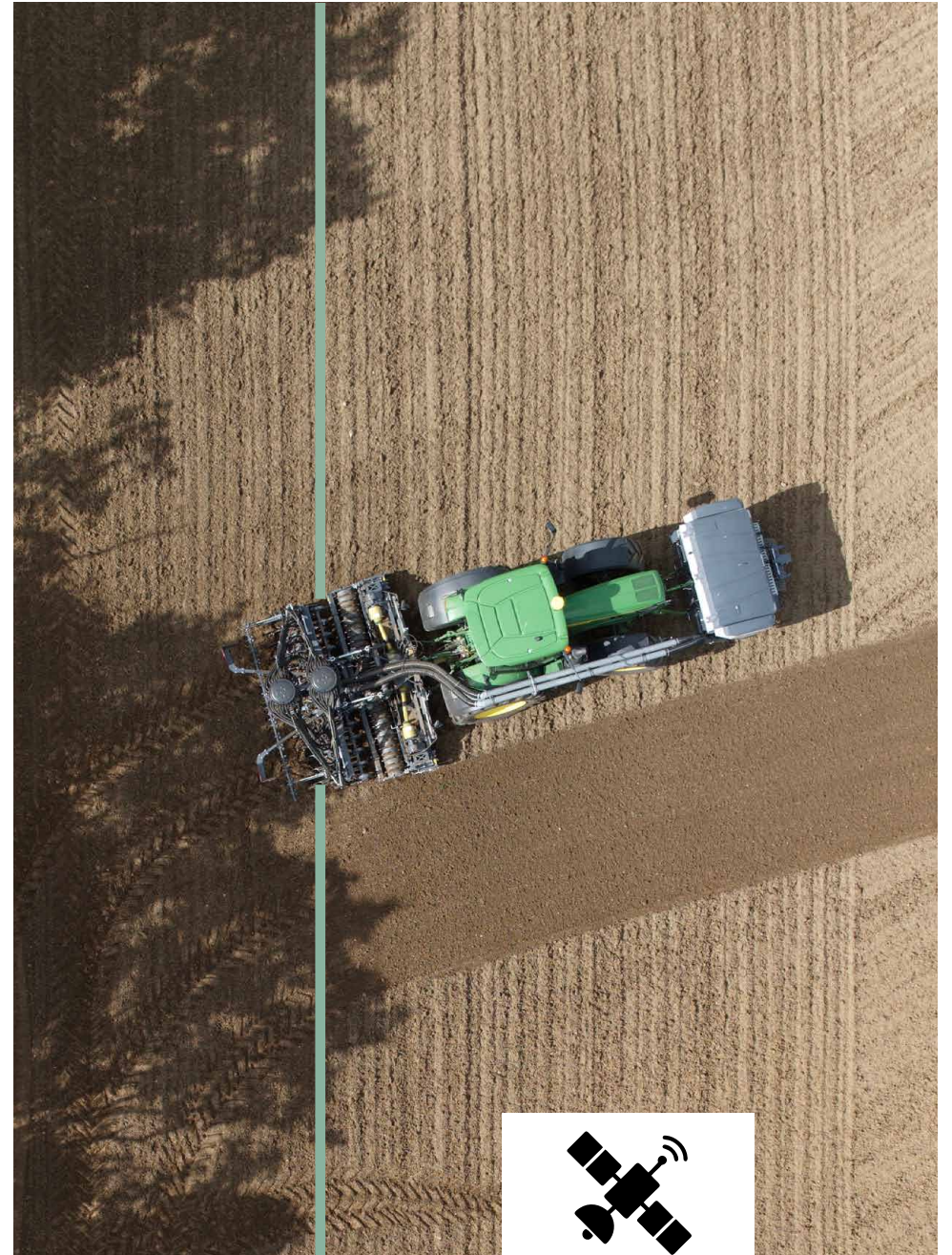



# Modulation **TC-GEO**

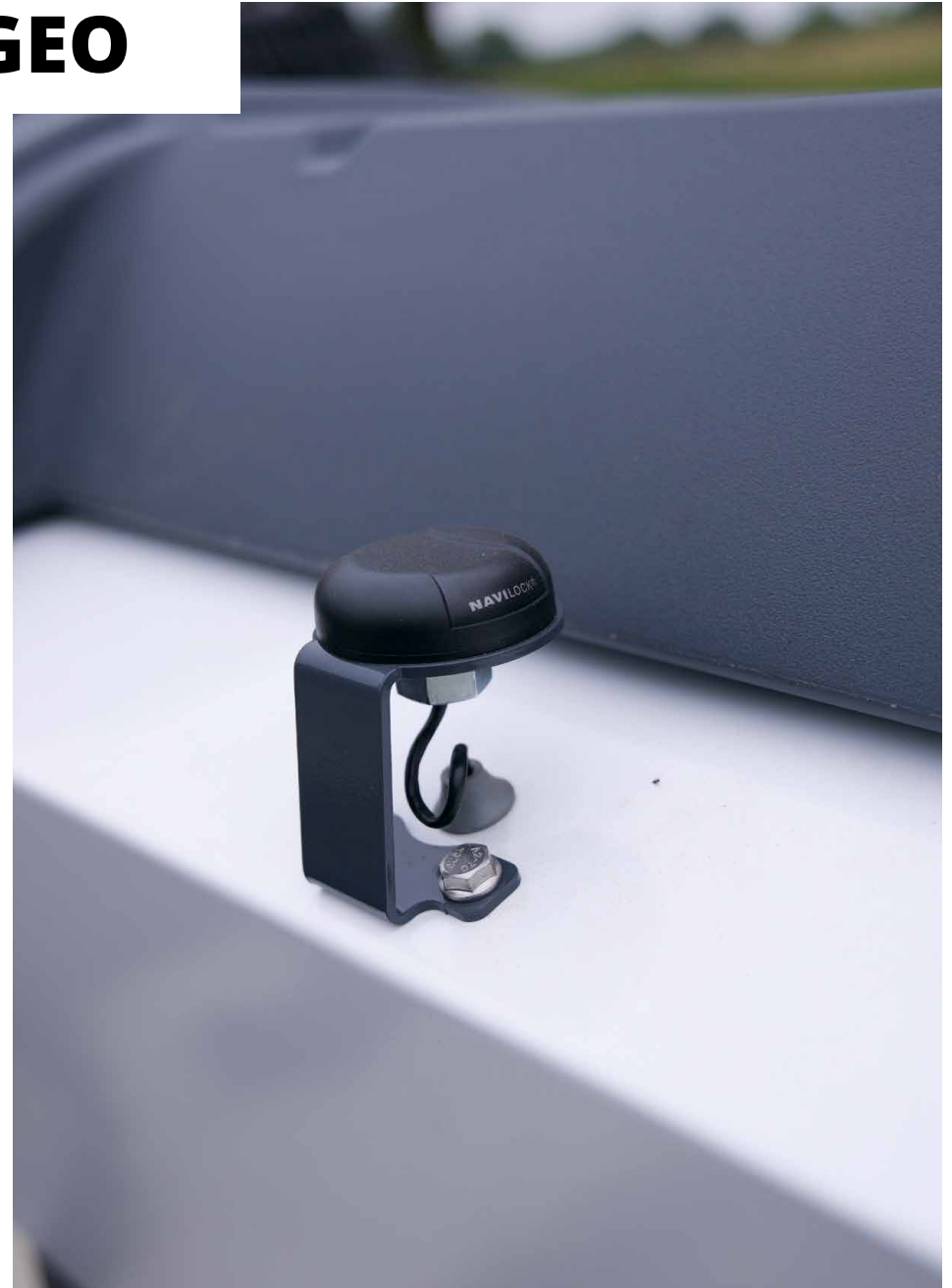



# Tramline Control **TC**







CCI 1200



CCI 800



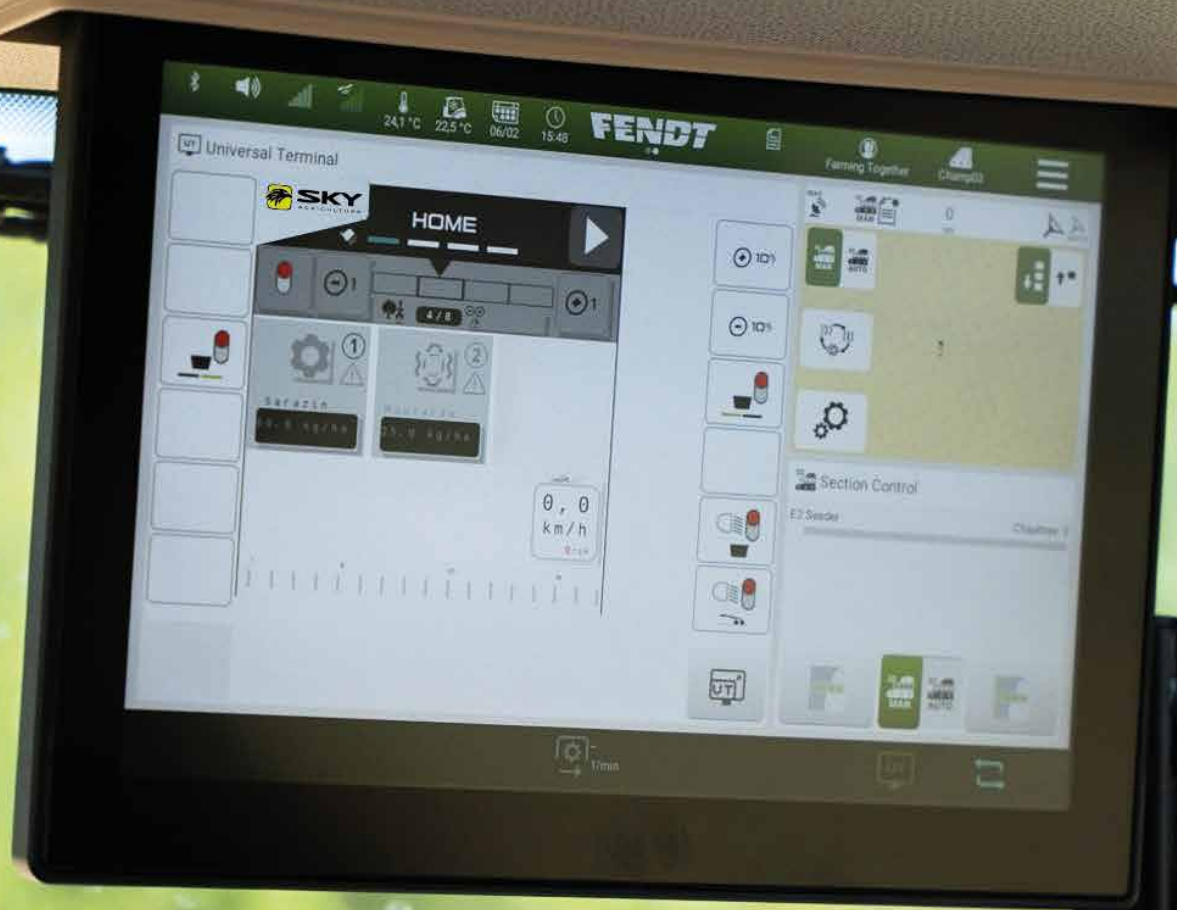

AEF Certified

**ISO BUS**

[www.aef-Isobus-database.org](http://www.aef-Isobus-database.org)

UT	TECU	AUX-IN
TC-BAS	TC-GEO	TC-SC
CC	CC	CC



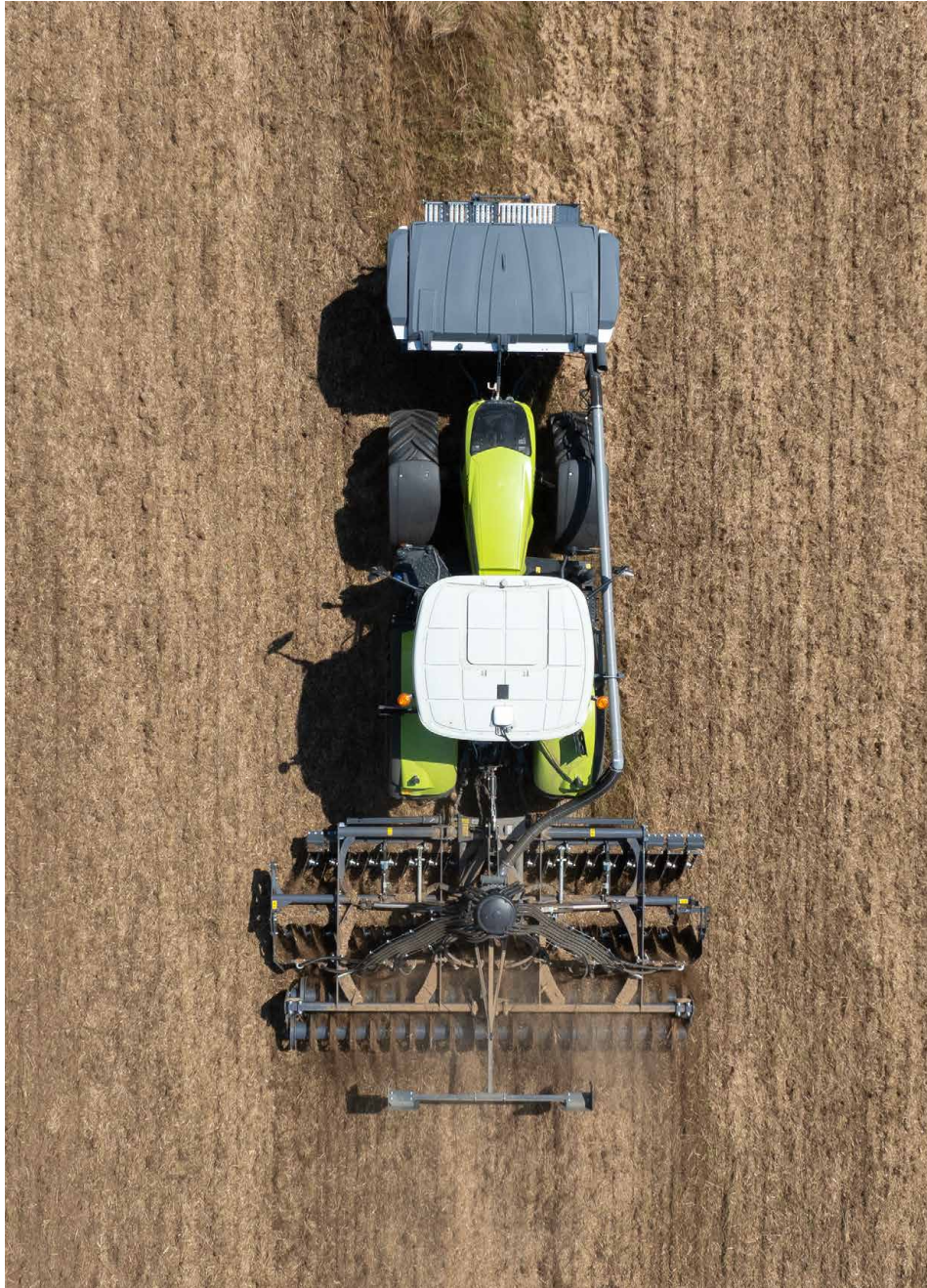























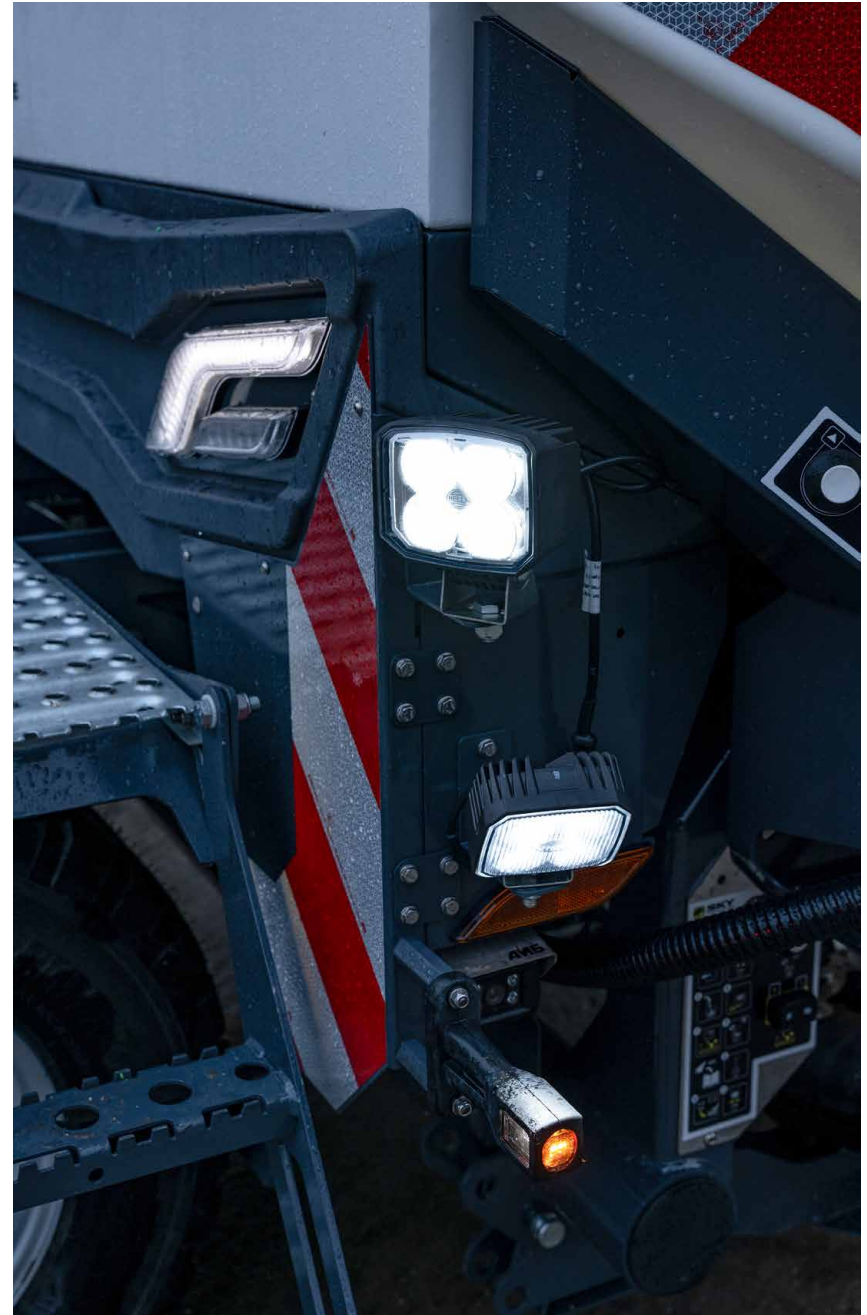









P20



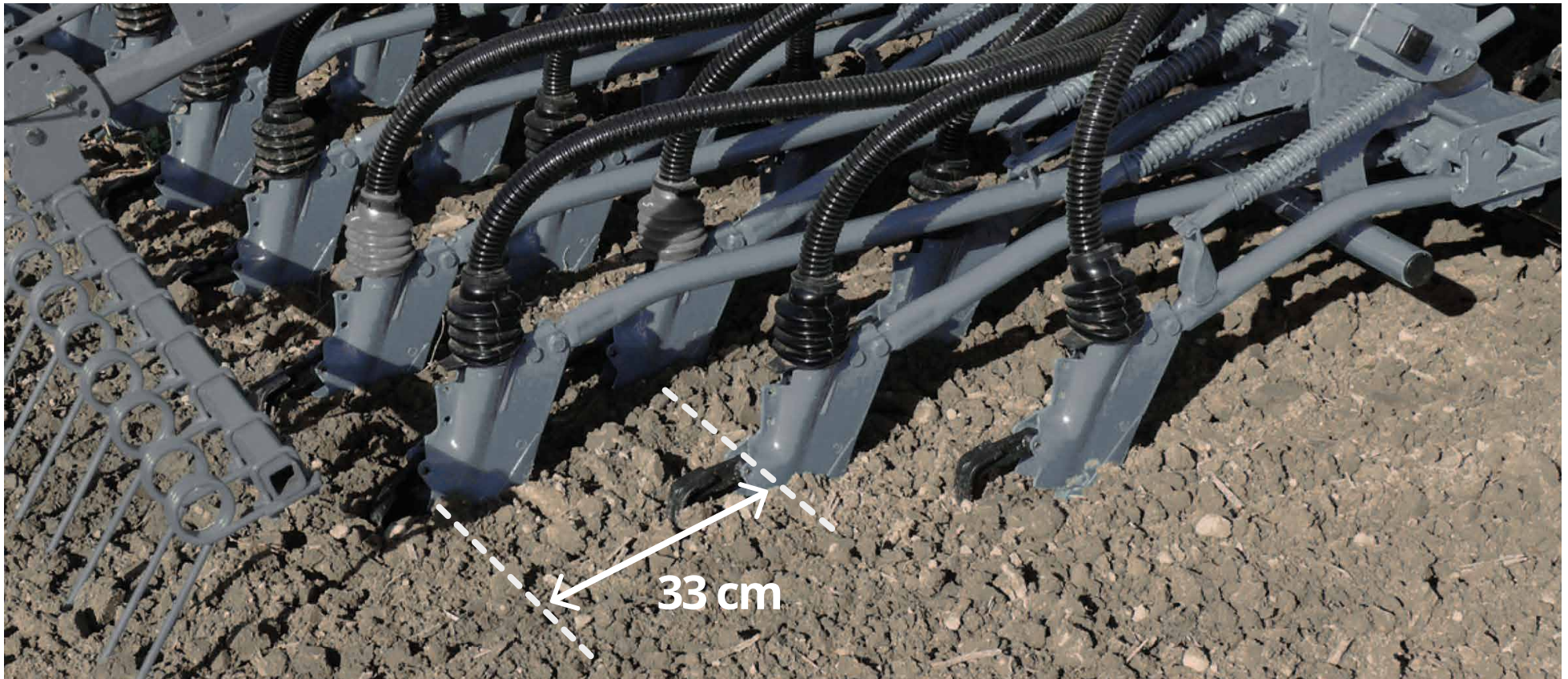
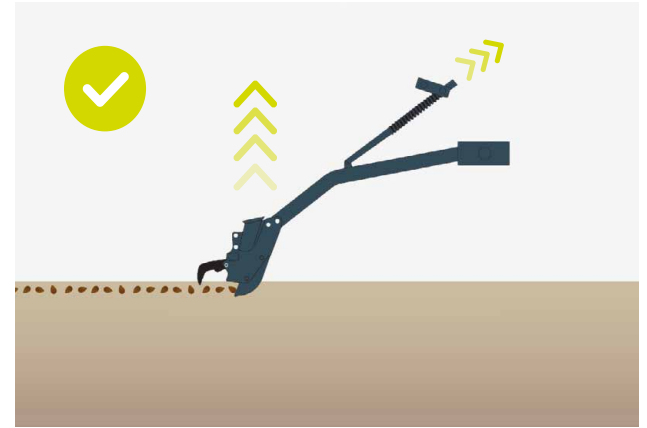
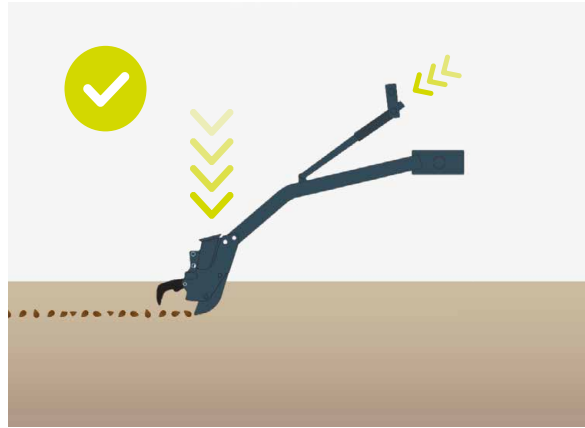
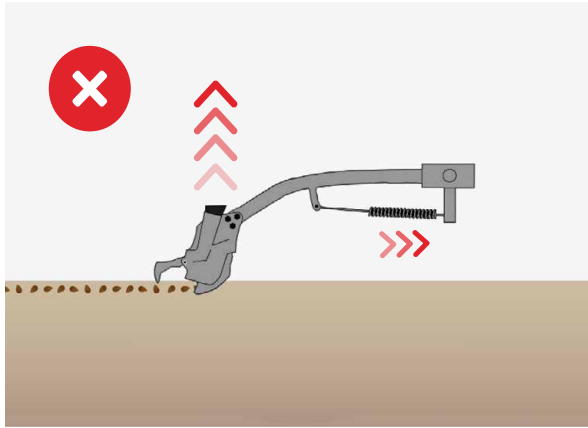





P30



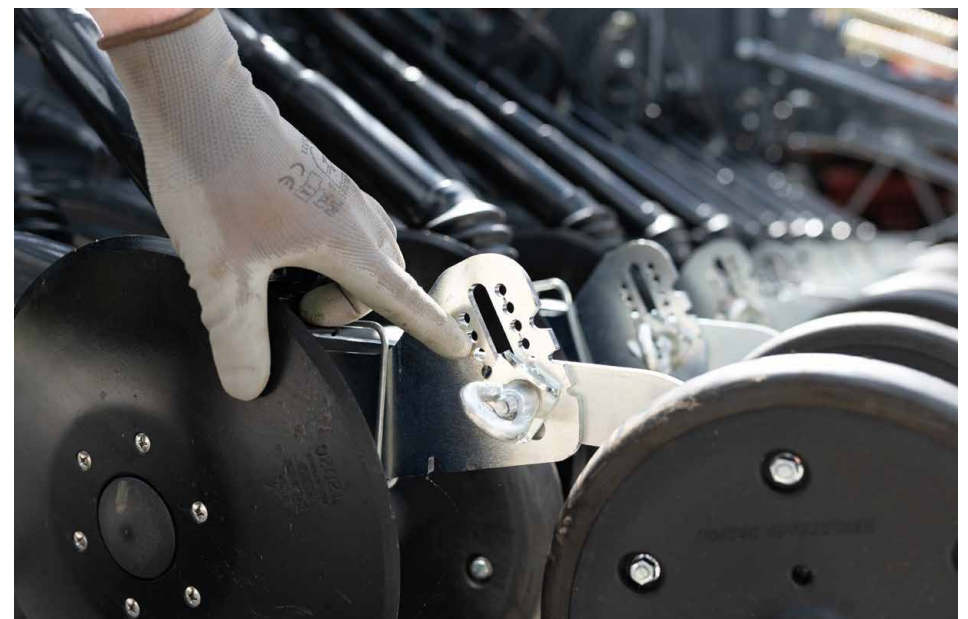
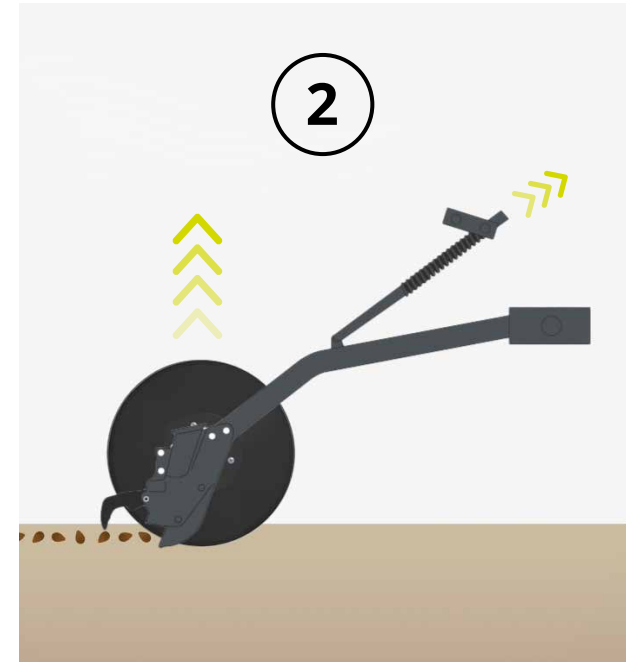
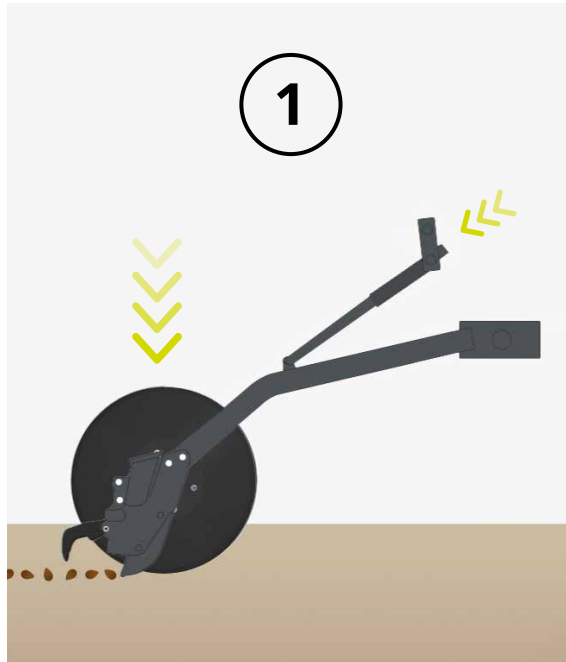





P50



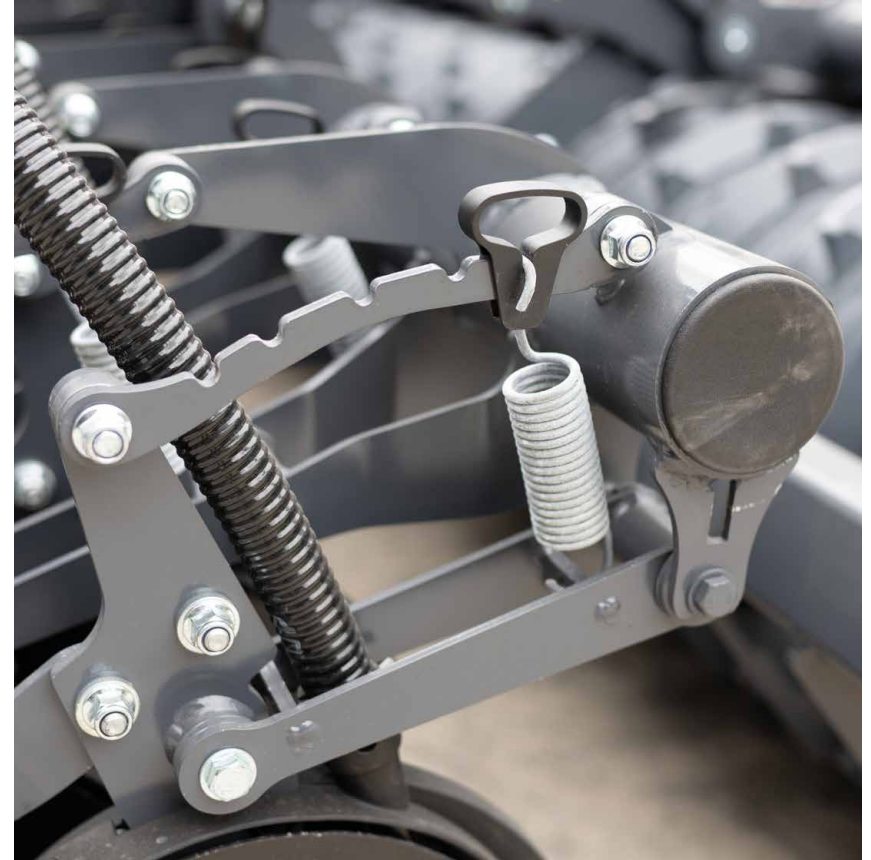
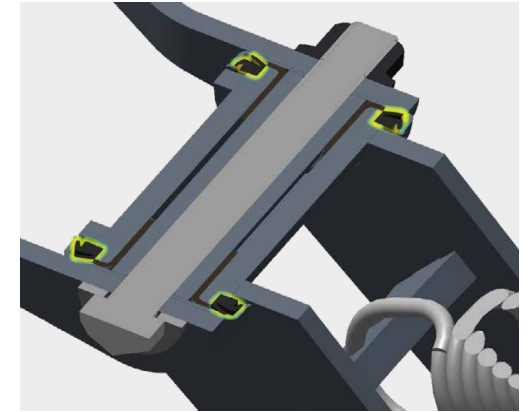
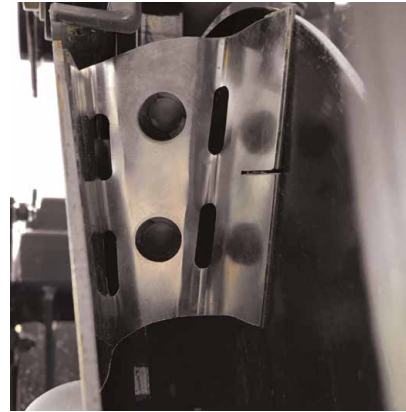





P100



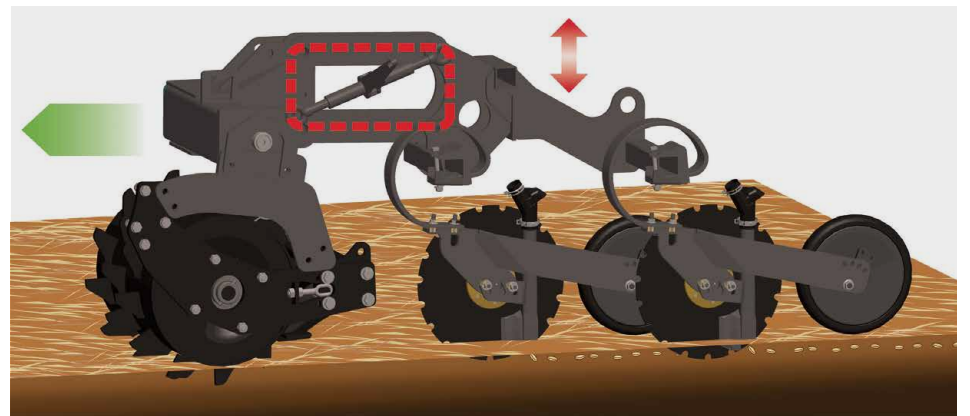
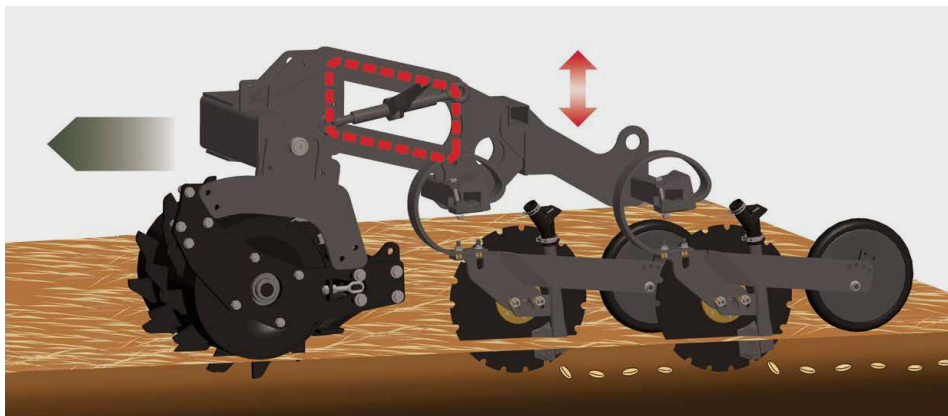
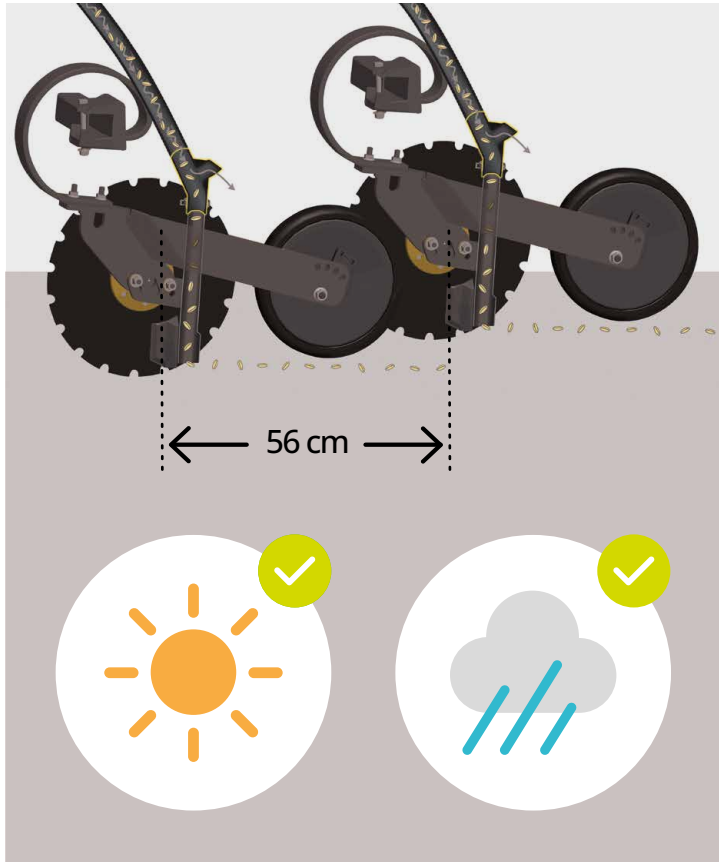



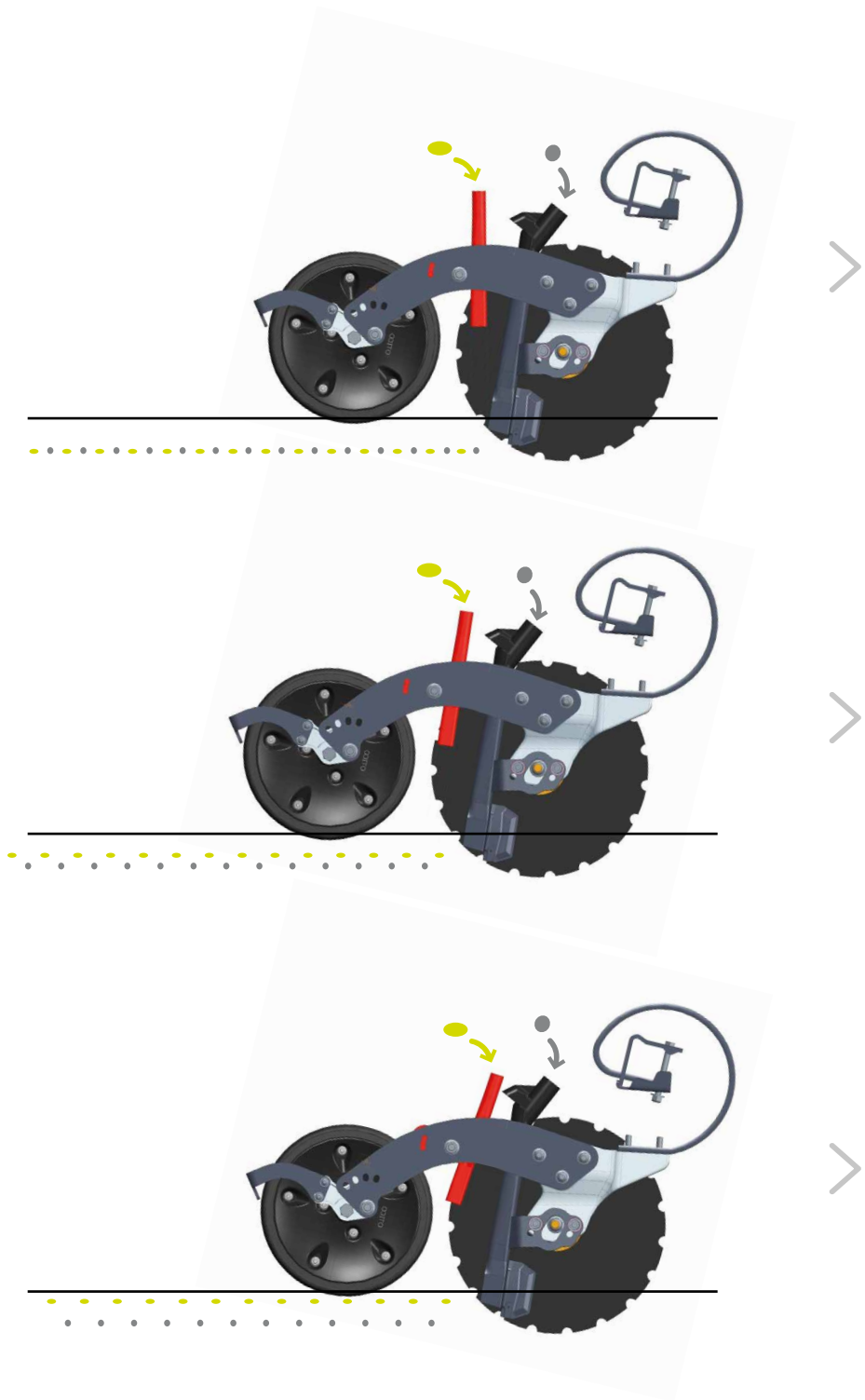







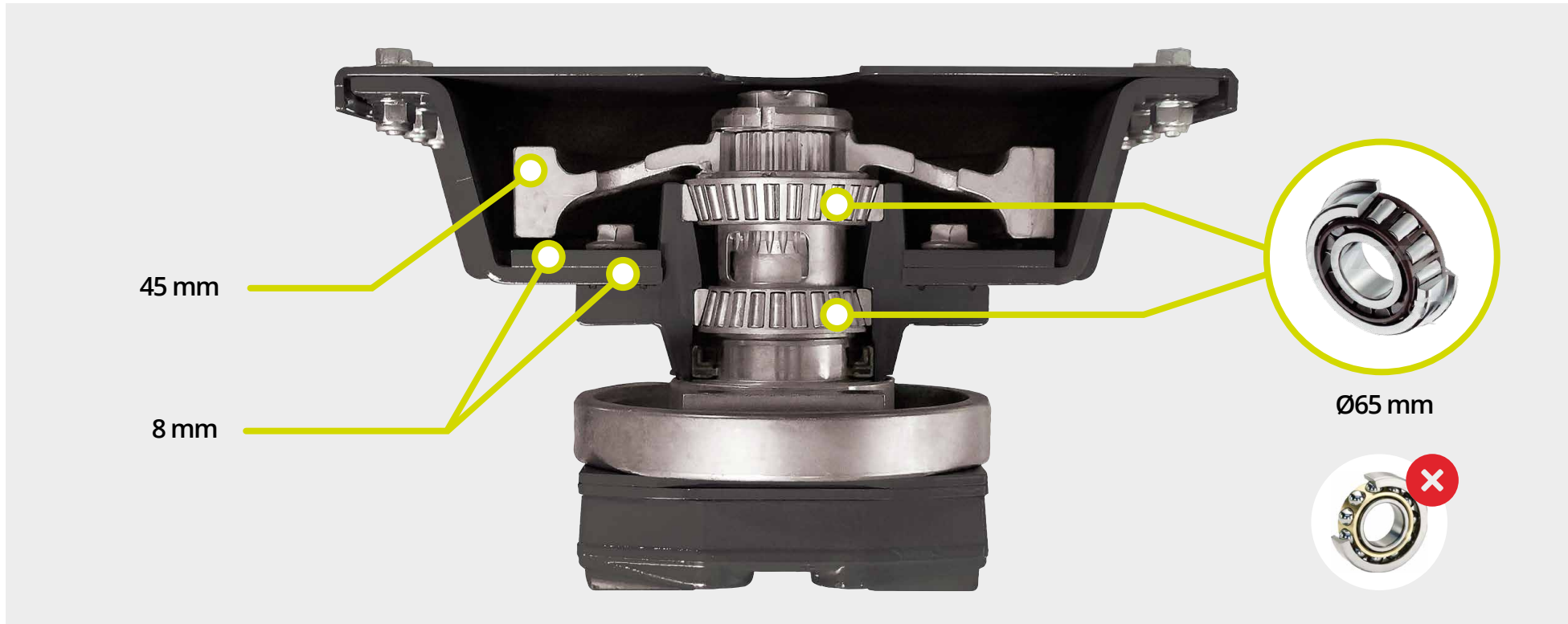



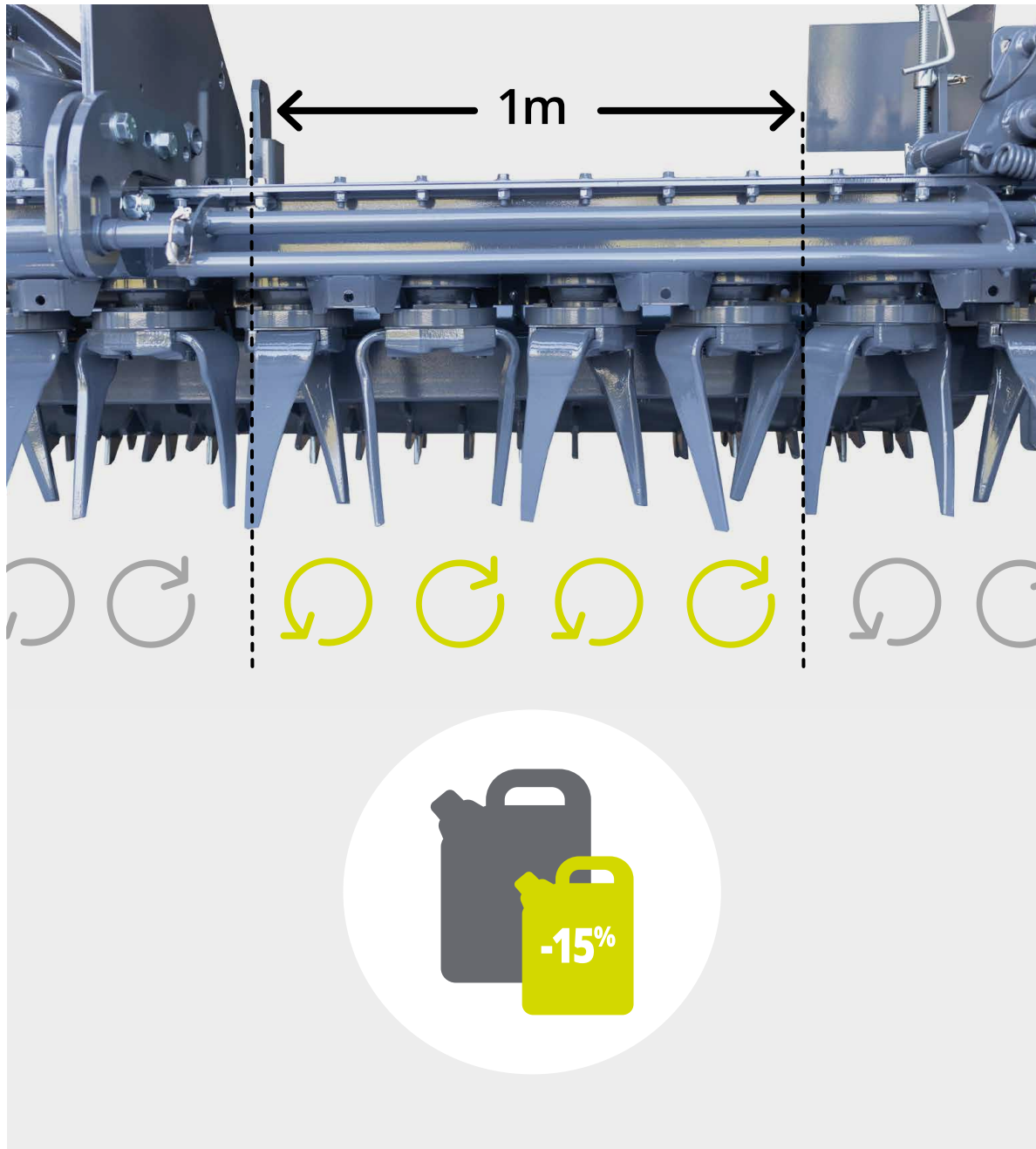

**RapidFit**

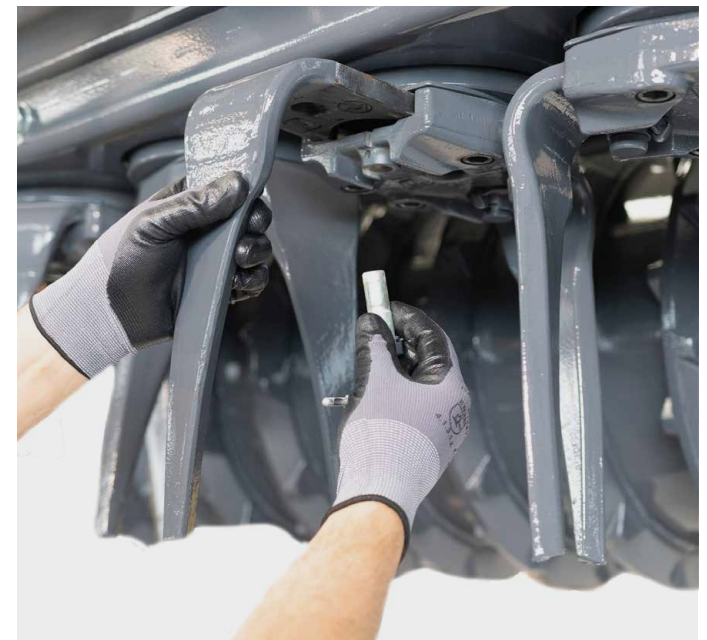



**Cage**  
Ø500 mm



**Gravity**  
Ø520 mm



**Packer**  
Ø550 mm



**Tracker**  
Ø550 mm

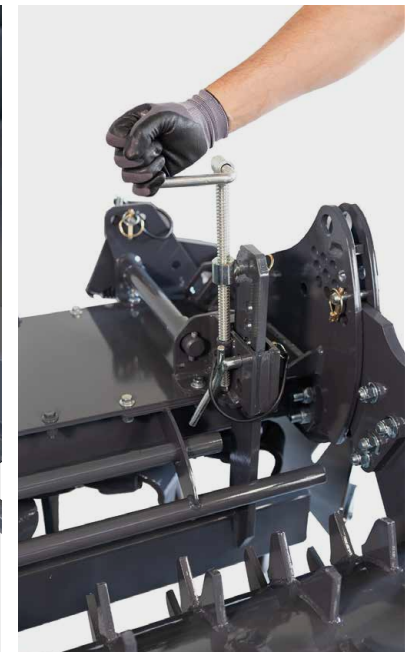







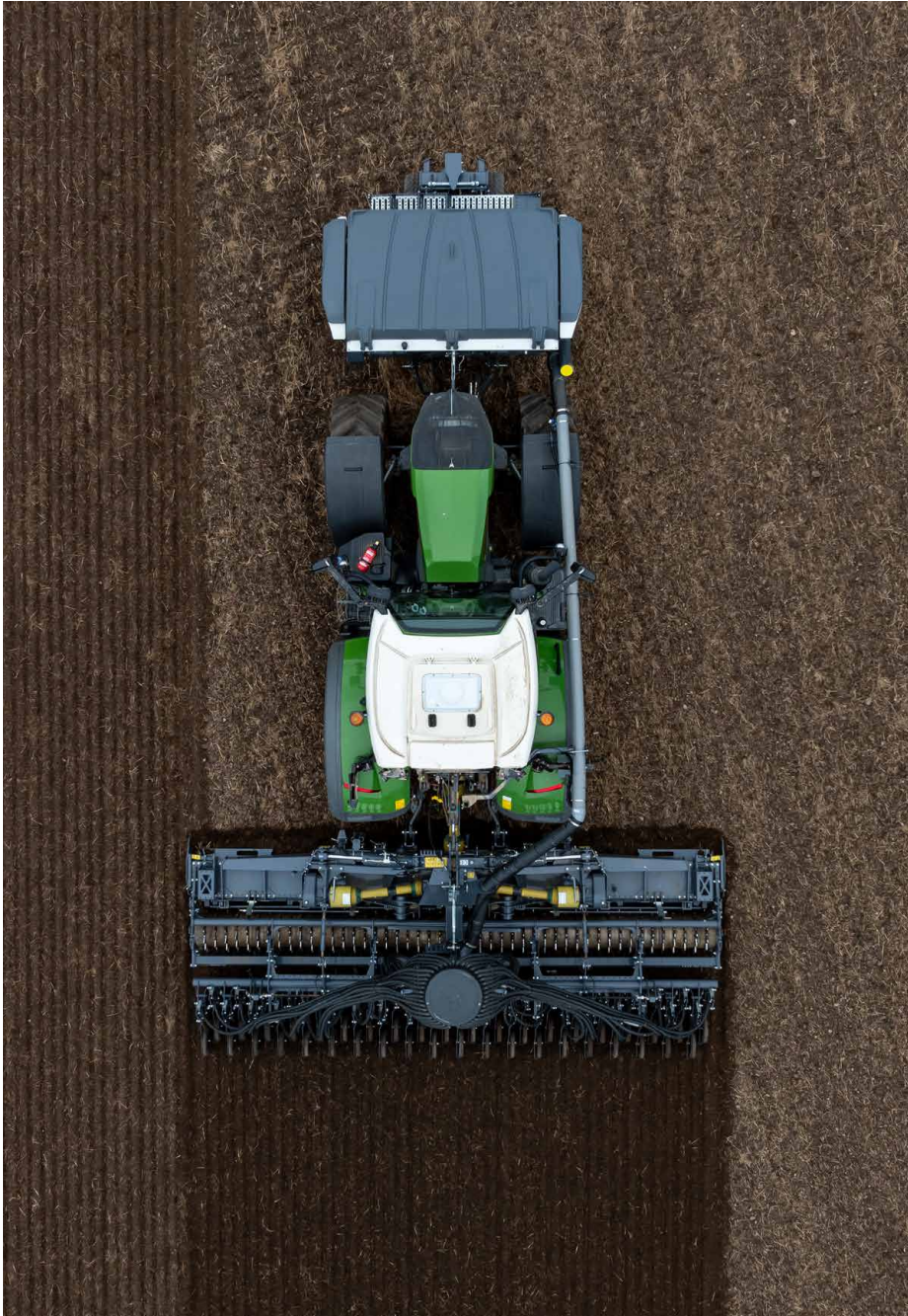





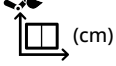

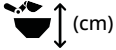
# PROGRESS TF



	2
 (L)	1100 + 1100
 (L)	100 (x2)
 (cm)	1100 x 1700
 (cm)	175
 (cm)	148
 (kg)	850





# HR

Type	HR 190	HR 220		HR 300			HRW 28				HRW 36		
 (kg) Packer Ø550	1700	1857	2041	1734	1937	2120	2770	2980	3190	3610	3710	4130	4550
 (m)	3	3,5	4	3	3,5	4	4	4,5	5	6	6	7	8
 (m)	-	-	-	-	-	-	2,95				2,95		
 (CV)	190	220		300			280				360	360	
	12	14	16	12	14	16	16	18	20	24	24	28	32

# SEEDING LINE

Type	Rigid P20		Rigid P30		Rigid P50						Rigid P100		
 (m)	4		4		3		3,5		4		3	3,5	4
	28	32	28	32	24	20	28	24	32	28	20	24	28
 (cm)	14,3	12,5	14,3	12,5	12,5	15	12,5	14,6	12,5	14,3	15	14,6	14,3

Type	Folding P20				Folding P30				Folding P50				Folding P100												
 (m)	4	4,5	5	6	4	4,5	5	6	4	4,5	5	6	4	4,5	5	6									
	28	32	36	32	40	28	32	36	32	40	28	32	36	32	40	28	30	32	40						
 (cm)	15	12,5	14	12,5	15,6	12,5	15	14,3	12,5	14	12,5	15,6	12,5	15	15	12,5	14	12,5	15,6	12,5	15	14,3	15	15,6	15





### Châteaubourg

P.A. de la Gaultière  
35220 Châteaubourg

### Fontenay

21 Rue Jean Monnet  
28630 Fontenay-sur-Eure

### Osasco

Via Garzigliana, 37  
10060 Osasco TO, Italie

### Ferme de la Conillais

Saint-Émilien-de-Blain  
44130 Blain

☎ Tél : +33 (0)2 99 00 84 84

✉ [contact@sky-agriculture.com](mailto:contact@sky-agriculture.com)

🌐 [sky-agriculture.com](http://sky-agriculture.com)