

Power harrows

Rigid and foldable power harrows



TWIN
FORCE

ALPEGO MECHANICS

SFERA

The ball-bearing mechanics is mounted on a wide range of power harrows, up to 6 meter wide and it offers excellent structural performances. The machines equipped with this kind of solution are ideal for the preparation of the seedbed.



SFERA
Clearance 75 mm



NEW

TWIN FORCE TEK

The patented TWIN FORCE TEK, used in the professional models is ideal for deep soil cultivation and combined machines. The machines equipped with this type of mechanics are suited to be used with high-power tractors.

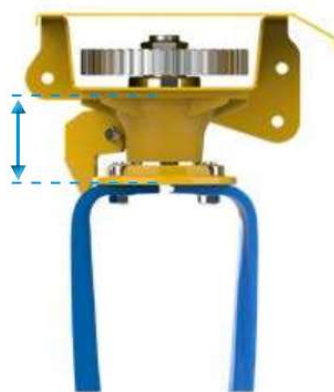

TWIN FORCE TEK
Clearance 130 mm



TWIN FORCE MAX

The patented solution TWIN FORCE MAX, used in the top-of-the-range professional models further improves the structural features and yields the utmost reliability in the use of very high power tractors of up to 500 HP.

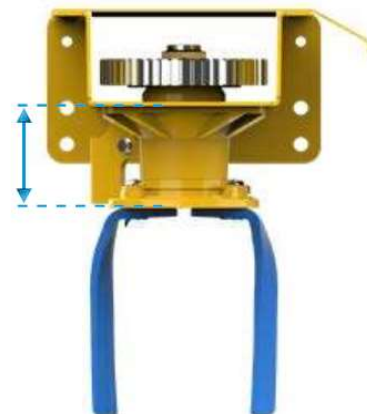

TWIN FORCE MAX
Clearance 165 mm



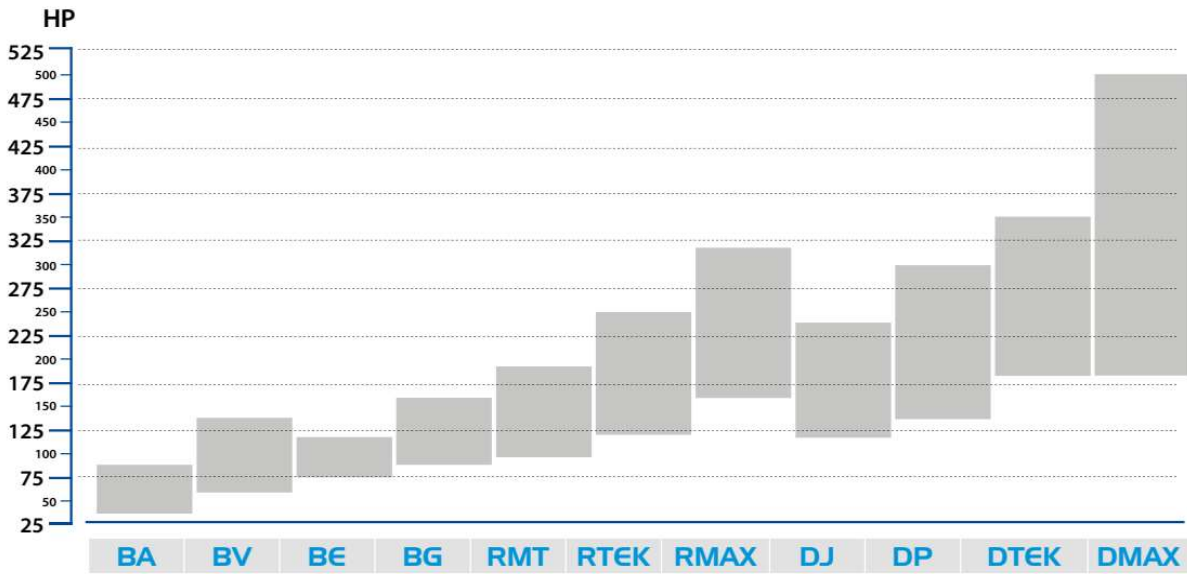

PARALLELOGRAM ROLLER LINKAGE

With the PARALLELOGRAM system of depth adjustment, the rear roller constantly maintains the same degree of inclination, therefore:

- The leveling bar is constantly correctly adjusted;
- In the combination with a seed-drill the pressure of the seeding coulters is kept constant

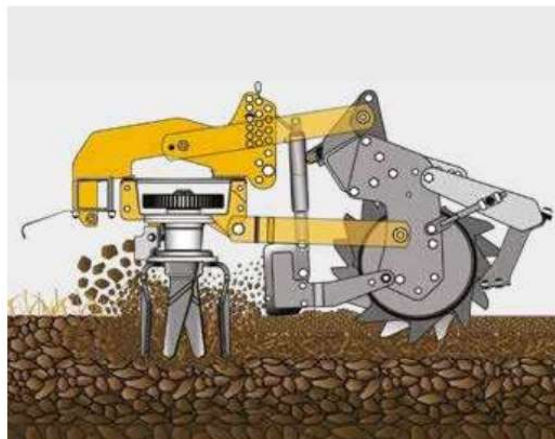

BA

Rigid power harrow
HP 35-85



KENMERKEN

- Rotoren ontworpen om vastlopen van de grond te voorkomen
- Steenvangens onder de tandwielbak
- Verstelbaar rol
- Rol met snelle diepteregeling
- Verkleinde totale afmetingen gelijk aan de werkbreedte
- Stalen frame met hoge treksterkte

STANDAARD UITRUSTING

- Versnellingsbak met één snelheid van 540 tpm (rotorrotatie 300 tpm)
- Aandrijfjas met breekbout 1"3/8 Z=6
- 3-punts hefaankoppeling tractor cat. I en II
- Verstelbare zijplaten
- Standaard stalen tanden

Mod.	HP	mm	mm	mm	(n°)	(n°)	Kg
BA 100	35-85	1035	1075	190	4	4+4	295
BA 130	40-85	1270	1310	190	5	6dx+4sx	330
BA 150	46-85	1505	1545	190	6	6+6	360
BA 170	51-85	1740	1780	190	7	6dx+8sx	375
BA 200	57-85	1975	2015	190	8	8+8	410
BA 220	62-85	2210	2250	190	9	10dx+8sx	440

Veel voorkomende uitvoeringen :

Incl. aftakas met breekbout en egalisatiebalk

	Met pakkerwals PK1A	Met spiraalrol SP1A
BA-100	€ 6.540	€ 6.320
BA-130	€ 7.190	€ 6.970
BA-150	€ 7.871	€ 7.621
BA-170	€ 8.579	€ 8.269
BA-200	€ 9.243	€ 8.913
BA-220	€ 10.109	€ 9.689

Overige opties vermeld achter in de prijslijst

BV

Rigid power harrow
HP 60-140



KENMERKEN

- Rotoren ontworpen om vastlopen van de grond te voorkomen
- Steenvangens onder de tandwielbak
- Verstelbaar rol
- Rol met snelle diepteregeling
- Verkleinde totale afmetingen gelijk aan de werkbreedte
- Stalen frame met hoge treksterkte

STANDAARD UITRUSTING

- Versnellingsbak met één snelheid van 540 tpm (rotorrotatie 300 tpm)
- 3-punts hefaankoppeling tractor cat. I en II
- In hoogte verstelbare zijplaten
- Verstelbare egalisatiebalk bevestigd aan rol
- Standaard stalen tanden

Mod.	HP	mm	mm	mm	(n°)	(n°)	Kg
BV 140	60-140	1361	1385	250	5	4dx+6sx	440
BV 160	70-140	1596	1620	250	6	6+6	490
BV 180	75-140	1831	1855	250	7	8dx+6sx	540
BV 205	90-140	2066	2090	250	8	8+8	590

Veel voorkomende uitvoeringen :

Incl. aftakas met breekbout en egalisatiebalk

	Met kooirol G4	Met pakkerwals PK3
BV-140	€ 8.160	€ 9.180
BV-160	€ 9.000	€ 10.150
BV-180	€ 9.740	€ 11.100
BV-205	€ 10.240	€ 11.690

Opties :

Aftakas met nokkenskoppeling	€ 910
------------------------------	-------

Overige opties vermeld achter in de prijslijst

Rigid power harrow HP 75-120









KENMERKEN

- Rotoren ontworpen om vastlopen van de grond te voorkomen
- Steenvangsers onder de tandwielbak
- Verstelbaar rol
- Rol met snelle diepteregeling
- Verkleinde totale afmetingen gelijk aan de werkbreedte
- Stalen frame met hoge treksterkte

STANDAARD UITRUSTING

- Versnellingsbak met één snelheid van 540 tpm (rotorrotatie 300 tpm)
- Aftakas met breekbout 1"3/8 Z=6
- Egalisatiebalk bevestigd aan de rol met onafhankelijke afstelling d.m.v. spindel
- 3-punts hefaankoppeling tractor cat. 2, meebewegend
- Beweegbare en verstelbare zijplaten
- Standaard stalen tanden

Mod.	 HP	 mm	 mm	 mm	 (n°)	 (n°)	 Kg
BE 230	75-120	2300	2300	250	9	8dx+10sx	630
BE 250	80-120	2500	2500	250	10	10+10	670
BE 300	85-120	2980	3000	250	12	12+12	750

Veel voorkomende uitvoeringen :
Incl. aftakas met breekbout

	Met kooirol G4	Met pakkerwals PK3
BE-230	€ 10.550	€ 12.430
BE-250	€ 11.290	€ 13.090
BE-300	€ 12.260	€ 14.360

Overige opties vermeld achter in de prijslijst



Rigid power harrow HP 65-140 / KW 48-104









KENMERKEN

- Rotoren ontworpen om vastlopen van de grond te voorkomen
- Steenvangers onder de tandwielbak
- Verstelbare rol
- Rol met snelle diepteregeling
- Centraal gelegen p.t.o.
- Verkleinde totale afmetingen gelijk aan de werkbreedte
- Stalen frame met hoge treksterkte

STANDAARD UITRUSTING

- 540rpm versnellingsbak Z=19/17 > 270/340 g./m.
- Aandrijfjas met breekbout 1"3/8 Z=6
- Egalisatiebalk bevestigd aan de rol met onafhankelijke afstelling d.m.v. spindel
- 3-punts hefaankoppeling tractor cat. 2, meebewegend
- Beweegbare en verstelbare zijplaten

Mod.	 Kw	 mm	 mm	 mm	 (n°)	 (n°)	 Kg
BF-250	48-104	2500	2500	250	10	10+10	720
BF-300	55-104	2980	3000	250	12	12+12	810

UITLOOP - wordt vervangen door nieuwe BG serie

**Nog enkele modellen beschikbaar in onderstaande uitvoeringen :
Informeer naar beschikbaarheid**

BF-300 met G4 kooirol			€ 13.330
BF-300 met PK3 pakkerwals			€ 15.410

Op aanvraag nog leverbaar in frontuitvoering

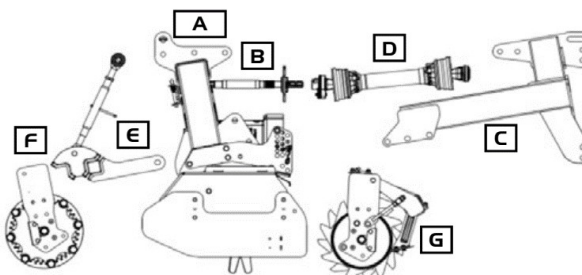

Rigid power harrow HP 85-160



KENMERKEN

- Rotoren ontworpen om vastlopen van de grond te voorkomen
- Steenvangers onder de tandwielbak
- Rol met snelle diepteregeling
- Centraal gelegen P.t.o.
- Verkleinde totale afmetingen gelijk aan de werkbreedte

STANDAARD UITRUSTING

1000 RPM versnellingsbak Z=21/33>343 g./m.

- Leverbaar ook met 540 toeren versnellingsbak. Hiervoor is het nodig tandwielen te wisselen voor toerentalverandering en een speciale aftakas is nodig.
- Egalisatiebalk bevestigd aan de rol. Onafhankelijk instelbaar
- 3-punts hef cat. 2 oscillerend
- Beweegbare zijplaten en verstelbaar
- Standaard stalen tanden

Veel voorkomende uitvoeringen :

Incl. aftakas met breekbout

	Met kooirol G4	Met pakkerwals PK3
BG-250	€ 13.870	€ 15.670
BG-300	€ 14.800	€ 16.900

Meerprijzen :

Ombouw naar 540 rpm aandrijving - rotortoeren 336 tpm	
Aftakas + set tandwielen 25/29	€ 1.055

Opties :

Rapido uitvoering met gelamineerde snelwissel tanden - meerprijs	€ 1.990
Aftakas (1000 rpm) met nokkencoppeling	€ 980
Set sporenwissers	€ 580
Hydraulische hefinrichting	€ 3.510
Doorgaande aftakas (max. 10kW)	€ 395
Verlichting (alleen in combinatie met rol)	€ 1.050

BG-serie ook leverbaar in frontuitvoering

Overige opties vermeld achter in de prijslijst



FUNCTIES

Rotoren ontworpen om vastlopen van de grond te voorkomen
gemonteerd op kegellagers TWIN-FORCE "TEK"
Steenvangens onder de tandwielbak
Rol met snelle diepteregeling
Centraal gelegen P.t.o.

INNOVATIEVE KENMERKEN

CS versnellingsbak (tot 200 PK)
Nieuwe 'TWIN TEK'-mechanica
Nieuwe rotorsteunen
Nieuwe verwijderbare gegoten steenbeschermers
Versterkte transmissietandwielen
Nieuwe beweegbare zijpanelen

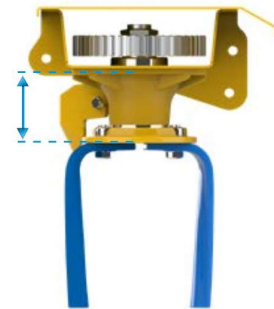

TWIN FORCE TEK
Clearance 130 mm



STANDAARD UITRUSTING

1000 RPM versnellingsbak 1000 T/min. Z=21/33>343 omw./min

Aftakas met breekboutbeveiliging

Egalisatiebalk bevestigd aan de rol. Onafhankelijk instelbaar
3-punts hef cat. 2e oscillerend
Beweegbare zijplaten en verstelbaar
Standaard stalen tanden

Rapido versie met gesmeed stalen tanden met 3 gaten

Veel voorkomende uitvoeringen :

Incl. aftakas met breekbout

	Met kooirol G5	Met pakkerwals PK5	Met pakkerwals PK4L φ 520
RMT-300	€ 19.057	€ 21.247	-
RMT-350	€ 20.780	€ 23.550	€ 22.640
RMT-400	€ 22.920	€ 26.560	€ 25.450

Uitvoering RAPIDO met snelwissel gesmede tanden - meerprijs	RMT-300	€ 850
Uitvoering RAPIDO met snelwissel gesmede tanden - meerprijs	RMT-350	€ 1.310
Uitvoering RAPIDO met snelwissel gesmede tanden - meerprijs	RMT-400	€ 1.710

Opties :

Aftakas met nokkencoppeling (RMT-AUTO) - meerprijs	€ 980
Set sporenwissers	€ 580
Hydraulische hefinrichting	€ 3.510
Doorgaande aftakas (max. 10kW)	€ 395
Verlichting (alleen in combinatie met rol)	€ 1.050

RMT-serie ook leverbaar in frontuitvoering

Front linkage power harrows

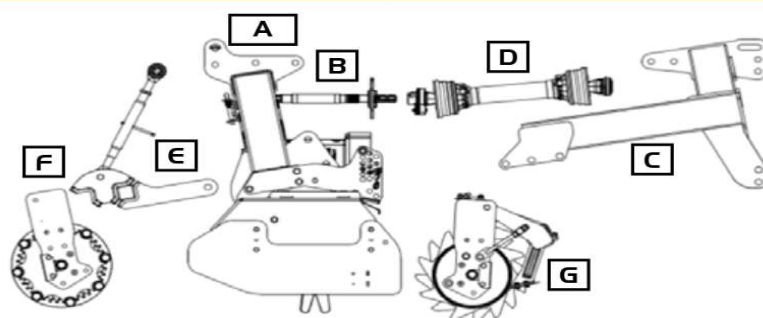

Mod.	HP	mm	mm	mm	(n°)	(n°)	Kg
BG 250	85-160	2511	2550	250	10	10+10	790
BG 300	95-160	2981	3000	250	12	12+12	875
RMT 300	95-200	2933	2995	250	12	12+12	1035
RMT 350	105-200	3403	3465	250	14	14+14	1140

De frontuitvoering voor zowel de BG als de RMT serie bestaat uit de volgende componenten :

Een standaard BG of RMT rotorkoep zonder rol en opties (A)			
Doorgaande aftakas uit 1 stuk (B)			
Frontbok (C)			
Lange aftakas met breekboutbeveiliging (D)			
Zonder rol(len)			
			Meerprijs
	met kooirol G4 (pos.G)	met pakkerwals PK3 (pos.G)	Extra kooirol G4 (Pos. E+F)
BG-250 Front	€ 16.180	€ 17.980	€ 3.220
BG-300 Front	€ 17.110	€ 19.210	€ 3.340

			Meerprijs
	met kooirol G5 (pos.G)	met pakkerwals PK5 (pos.G)	Extra kooirol G4 (pos. E+F)
RMT-300 Front	€ 22.410	€ 24.600	€ 3.340
RMT-350 Front	€ 24.200	€ 26.970	Op aanvraag

Meerprijzen :

		RMT-300	RMT-350
Set geharde, snelwissel tanden	€	850	€ 1.310

Voor combi-gebruik voor en achter de tractor nog een extra aftakas voor achter bijtellen.

Aftakas voor gebruik achter de tractor - aftakas met breekbout	€	660
aftakas voor gebruik achter de tractor - aftakas met nokkenkoppeling	€	1.620

RK

Rigid power harrow
HP 90-200 / KW 67-148

TWIN
FORCE









KENMERKEN

- Rotoren ontworpen om vastlopen van de grond te voorkomen, gemonteerd op kegellagers TWIN-FORCE "K"
- Steevangens onder de tandwielbak
- Rol gemonteerd op een parallellogram
- Rol met snelle diepteregeling
- Centraal gelegen P.t.o.
- Verkleinde totale afmetingen gelijk aan de werkbreedte
- Stalen frame met hoge treksterkte

STANDAARD UITRUSTING

- 1000 RPM versnellingsbak Z=21/33 > 343 g./m.
- Egalisatiebalk bevestigd aan de rol met onafhankelijke afstelling d.m.v. spindel
- 3-punts hefaankoppeling tractor cat. 3, meebewegend
- Beweegbare zijplaten en verstelbaar
- Gesmede tanden (RAPIDO-versie)

Mod.	 Kw	 mm	 mm	 mm	 (n°)	 (n°)	 Kg
RK-300	67-148	2985	3000	280	12	12+12	1180
RK-300 RAPIDO	67-148	2985	3000	280	12	12+12	1260
RK-350	74-148	3455	3500	280	14	14+14	1310
RK-350 RAPIDO	74-148	3455	3500	280	14	14+14	1400
RK-400	90-148	4076	4000	280	16	16+16	1450
RK-400 RAPIDO	90-148	4076	4000	280	16	16+16	1570

UITLOOP - wordt vervangen door nieuwe RTEK serie

**Nog enkele modellen beschikbaar in onderstaande uitvoeringen :
Informeer naar beschikbaarheid**

RK-300 met nokkenskoppeling en G5N kooirol	€ 20.930
RK-300 nokkenskoppeling en PK6R pakkerwals	€ 24.700

Rigid power harrow HP 120-250



FUNCTIES

- Rotoren ontworpen om vastlopen van de grond te voorkomen, gemonteerd op kegelagers TWIN-FORCE "TEK"
- Steevangens onder de tandwielbak
- Rol met snelle diepteregeling
- Centraal gelegen P.t.o.
- Verkleinde totale afmetingen gelijk aan de werkbreedte

INNOVATIEVE KENMERKEN

- Verhoging maximaal toelaatbaar vermogen (tot 250 pk)
- Nieuwe 'TWIN TEK'-mechanica
- Nieuwe rotorsteunen
- Nieuwe verwijderbare gegoten steenbeschermers
- Versterkte transmissietandwielen
- Nieuwe beweegbare zijpanelen

STANDAARD UITRUSTING

- 1000 RPM versnellingsbak Z=29/25>368-273 oms./min.
- Egalisatiebalk op rol. Onafhankelijk instelbaar
- 3-punts hef cat. IIIe, oscillerend
- Beweegbare zijplaten en verstelbaar
- Gesmeed stalen 3-gaats tanden



Veel voorkomende uitvoeringen :

Incl. aftakas met nokkenkoppeling

	Met kooirol G5	Met pakkerwals PK5	Met pakkerwals PK6R
RTEK-300	€ 22.070	€ 24.260	€ 25.870
RTEK-350	€ 24.210	€ 26.980	€ 28.900
RTEK-400	€ 26.910	€ 29.550	€ 31.720

Uitvoering RAPIDO met snelwissel gesmede tanden - meerprijs	RTEK-300	€ 710
Uitvoering RAPIDO met snelwissel gesmede tanden - meerprijs	RTEK-350	€ 1.010
Uitvoering RAPIDO met snelwissel gesmede tanden - meerprijs	RTEK-400	€ 1.370

Opties :

Set sporenwissers	€ 590
Hydraulische hefinrichting - tot 1400 kg	€ 3.510
Hydraulische hefinrichting - tot 3000 kg	€ 5.910
Doorgaande aftakas (max. 10kW)	€ 540
Verlichting (alleen in combinatie met rol)	€ 1.050

Overige opties vermeld achter in de prijslijst

Rigid power harrow HP 160-320



KENMERKEN

- Rotoren ontworpen om vastlopen van de grond te voorkomen, gemonteerd op kegellagers TWIN-FORCE "MAX"
- Steevangers onder de tandwielbak
- Rol gemonteerd op een parallellogram
- Rol met snelle diepteregeling
- Centraal gelegen P.t.o.
- Verkleinde totale afmetingen gelijk aan de werkbreedte
- Stalen frame met hoge treksterkte

STANDAARD UITRUSTING

- 1000 RPM versnellingsbak Z=29/25 > 368-273 g./m.
- Aftakas Walterscheid met nokkenkoppeling 1"3/8 Z=6 tractorzijde
- Egalisatiebalk bevestigd aan de rol met onafhankelijke afstelling
- 3-punts hefaankoppeling tractor cat. 3, meebewegend
- Beweegbare zijplaten en verstelbaar
- Gesmede 3-gaats tanden

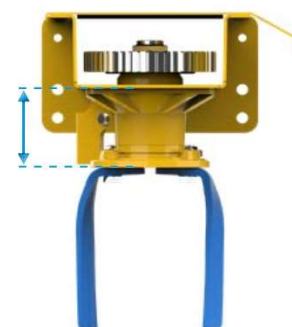

TWIN FORCE MAX
Clearance 165 mm



Veel voorkomende uitvoeringen :
Incl. aftakas met nokkenkoppeling

	Met kooirol G5	Met pakkerwals PK5	Met pakkerwals PK6R
RMAX-300	€ 24.840	€ 27.030	€ 28.640
RMAX-350	€ 27.540	€ 30.310	€ 32.230
RMAX-400	€ 30.090	€ 32.730	€ 34.900

Uitvoering RAPIDO met snelwissel gesmede tanden - meerprijs	RMAX-300	€ 660
Uitvoering RAPIDO met snelwissel gesmede tanden - meerprijs	RMAX-350	€ 860
Uitvoering RAPIDO met snelwissel gesmede tanden - meerprijs	RMAX-400	€ 1.110

Opties :

Set sporenwissers	€	590
Hydraulische hefinrichting - tot 1400 kg	€	3.510
Hydraulische hefinrichting - tot 3000 kg	€	5.910
Doorgaande aftakas (max. 10kW)	€	540
Verlichting (alleen in combinatie met rol)	€	1.050

Overige opties vermeld achter in de prijslijst

Optionals

The right accessory for every situation



Code	Classif.	Description	Mod.	Q.ty	Kg	€
S80A00116	-	Levelling bar	BA 100	x 1	20	330
S80A00117			BA 130	x 1	22	340
S80A00118			BA 150	x 1	26	351
S80A00119			BA 170	x 1	29	359
S80A00120			BA 200	x 1	35	373
S80A00121			BA 220	x 1	37	379



Code	Classif.	Description	Mod.	Q.ty	Kg	€
S85A00062	C	Kit side plate for roller protection	BV	x 1	7	220
S85A00054			BE/BG	x 1	10	156



Code	Classif.	Description	Mod.	Q.ty	Kg	€
S91A00024 ⁽¹⁾	A	Track eraser pair (60x12)	BA	x 1	29	415
S91A00023 ⁽²⁾		Pair of special track erasers for narrow wheelbase tractors (5-hole arm) Distance track eraser: from 854mm to 926mm	BV	x 1	33	450
S91A00011		Track eraser pair (5-hole arm) Distance track eraser: BV 160 : 1170mm BV 180-205 : from 1170mm to 1410mm	BV 160	x 1	38	580
			BV 180			
			BV 205			
S91A00005		Track eraser pair	BE/BG/ RMT	x 1	40	590
S91A00013		NO-STOP Track eraser pair (2 spring)	RTEK/ RMAX	x 1	45	590
+ C20A04810		Adapter kit from tube 80 to tube 100	RMT	x 1	65	1.120
				x 2	5	
S91A00013		NO-STOP Track eraser pair (2 spring)	RTEK/ RMAX	x 1	65	1.040

⁽¹⁾Not for use on BA-100 / For BA-130 only possible with couplings in 1 1/2"N category with 940mm centre distance)

⁽²⁾Only combinable with 1st/2nd category couplings (for N category only)



Code	Classif.	Description	Mod.	Q.ty	Kg	€
C15A00795 ⁽³⁾ + M80A00326 + M90A00053	A	One half rock guard	BE 230	x 18	1.5	31
			BE 250	x 20		
			BE 300	x 24		
			BE 230	x 36	0.13	3
			BE 250	x 40		
			BE 300	x 48		
			BE 230	x 36	1	1
			BE 250	x 40		
			BE 300	x 48		

⁽³⁾When factory mounted do not order screws and washers

Optionals

The right accessory for every situation



Code	Classif.	Description	Mod.	Q.ty	Kg	€
SA5A00076 ⁽⁴⁾	C	Hydraulic depth adjustment	BV 180 ⁽⁵⁾ / BV 250 ⁽⁵⁾ / BE ⁽⁵⁾ /BG	x 1	40	1.290
SA5A00033	A	Hydraulic depth adjustment	RMT	x 1	52	1.690
SA5A00112 + SZ9A00129	-	Hydraulic depth adjustment Hydraulic depth corrector hose kit	RTEK 300	x 1	50 -	2.059
SA5A00112 + SZ9A00130	-	Hydraulic depth adjustment Hydraulic depth corrector hose kit	RTEK 350/400	x 1	50 -	2.083
SA5A00031	B	Hydraulic depth adjustment	RMAX	x 1	61	1.880

⁽⁴⁾In case of combination with JET-A only for BE, it is mandatory to add **SA4A00043** *Kit JET-A for hydraulic register adaptation on BE* (€/Unit 128)



Code	Classif.	Description	Mod.	Q.ty	Kg	€
S40A00003 ⁽⁵⁾	A	Hydraulic linkage for seed-drill till 1400 Kg	BE/BG/ RMT/ RTEK/ RMAX	x 1	175	3.510
SZ9A00016		1400 Kg Hydraulic linkage stop switch kit	BE/BG/ RMT/ RTEK/ RMAX	x 1	5	375
S40A00005	C	Hydraulic linkage for seed-drill till 3000 Kg	RTEK/ RMAX	x 1	370	5.910
SZ9A00080	C	Double-acting hydraulic conversion kit 3000 kg	RTEK	x 1	6	160
SZ9A00017	C	3000 Kg Hydraulic linkage stop switch kit	RMAX	x 1	3	295

⁽⁵⁾NOTE: When combined with RMT do not combine with PACKER Roller PK4L, as an alternative fit PACKER Roller PKS.



Code	Classif.	Description	Mod.	Q.ty	Kg	€
SA1A00006 ⁽⁶⁾	A	Kit rear pto 1*3/8 Z=6	BE	x 1	4	395
SA1A00010 ⁽⁶⁾	A		BG	x 1	12	540
			RMT	x 1		
			RTEK	x 1		
		RMAX	x 1			

⁽⁶⁾Pto maximum power 10 Kw
Not compatible when combined with JET-M or JET-X seed drill



Code	Classif.	Description	Mod.	Q.ty	Kg	€
SA5A00113 + SZ9A00131		Hydraulic adjuster levelling bar (1 through-rod cylinder ø60)	BV/BE/ BG/RMT /RTEK/ RMAX- 300/350	x 1	20	637
		Hydraulic kit for levelling bar (single cylinder)		x 1	-	
SA5A00113 + SZ9A00132		Hydraulic adjuster levelling bar (1 through-rod cylinder ø60)	RMAX- 400	x 2	20	1.132
		Hydraulic kit for levelling bar (double cylinder)		x 1	-	



Code	Classif.	Description	Mod.	Q.ty	Kg	€
SZ9A00108	D	APV assembly kit available on power harrows/rotary tillers	RMT/RTEK/ RMAX	x 1	140	1.800

Optionals

The right accessory for every situation



Code	Classif.	Description	Mod.	Q.ty	Kg	€
S40A00044 ^(*)	B	JET-A mounting kit on harrows with roller series 3 (Not P41)	BV / BE	x 1	140	890

^(*)In case of combination with BV-150 mandatory add SZ9A00125 'JET-A BV-150 Adaptation Kit' (€ /Unit 152)



Code	Classif.	Description	Mod.	Q.ty	Kg	€
SZ9A00036	C	Set 8 rods for Cage roller G5-300	RMT/ RTEK/ RMAX	x 1	100	1.220
SZ9A00034		Set 8 rods for Cage roller G5-350	RMT/ RTEK/ RMAX	x 1	105	1.480
SZ9A00037		Set 8 rods for Cage roller G5-400	RTEK/ RMAX	x 1	125	1.460

Code	Classif.	Description	Mod.	Q.ty	Kg	€
SB1A00032	-	Rear light bar kit for fixed power harrows	ALL MODEL	x 1	20	1.050

Code	Classif.	Description	Mod.	Q.ty	Kg	€
S45A00073	A	Kit for roller attachment from series 3 to series 5	RMT	x 1	5	67

Code	Classif.	Description	Mod.	Q.ty	€
Q25A00224	-	Transport kit 3 pcs.	BA	x 1	ON REQUEST
Q25A00225	-	Transport kit 2 pcs.	BV	x 1	ON REQUEST
Q25A00129	-	Transport kit 2 pcs.	BE / BG / RMT / RTEK / RMAX	x 1	ON REQUEST

ALPEGO	BULLONATI / Bollet / Boulonné / Geschraubt / Atornillado						CONFEZIONI x10 Packages x10 Packung x10 Paquetes x10				
	STANDARD Geschichtet Estandar		FORGIATO Forged Geschmiedet Forjada		LAMINATO ANTIUSURA Laminated wearproof Geschichtet verschleißfest Laminado anti-desgaste		FORGIATO ANTIUSURA Forged wearproof Geschmiedet verschleißfest Forjado anti-desgaste		PLUS Plus with plate Wolframkarbidplatten Plus con placa		
MODEL											
RA	MK0A00205	MK0A00204							SCOA00012		
BA	MK0A00477	MK0A00476									
BD-BV-BE BF-BG-RM DJ-DP-DF-DM	MK0A00018	MK0A00013			MK0A00119	MK0A00115			SCOA00018	SCOA00023	
RMT-RG-RK DG-DK-DKS- DK TOP	MK0A00118	MK0A00114			MK0A00119	MK0A00115			SCOA00028		
RTEK			MK0A00469	MK0A00470			MK0A00489	MK0A00490	MK0A00491	MK0A00492	SCOA00179
DTEK	MK0A00118	MK0A00114	MK0A00469	MK0A00470	MK0A00119	MK0A00115	MK0A00489	MK0A00490	MK0A00491	MK0A00492	SCOA00028 SCOA00179
RH DH-DX-DXM	MK0A00135	MK0A00132			MK0A00136	MK0A00133					SCOA00024
RMAX DMAX			MK0A00453	MK0A00454			MK0A00431	MK0A00430	MK0A00455	MK0A00456	SCOA00123

Overzicht mogelijkheden tanden voor de rotoeggen met boutbevestiging

Prijzen per set van 2 (L+R) en bij vervanging - nalevering

Standaard stalen tanden - 2 gaats - set L+R

MK0A00477 + MK0A00476 - standaard tanden (L+R)	€ 46
MK0A00018 + MK0A00013 - standaard tanden (L+R)	€ 45
MK0A00118 + MK0A00114 - standaard tanden (L+R)	€ 48
MK0A00135 + MK0A00132 - standaard tanden (L+R)	€ 68



Optionele gesmede tanden - 2 gaats - set L+R

MK0A00469 + MK0A00470 - gesmede tanden (L+R)	€ 96
MK0A00453 + MK0A00454 - gesmede tanden (L+R)	€ 91



Optionele gelamineerde geharde tanden - 2 gaats - set L+R

MK0A00119 + MK0A00115 - geharde tanden, gelamineerd (L+R)	€ 118
MK0A00136 + MK0A00133- geharde tanden, gelamineerd (L+R)	€ 177



Optionele gesmede slijtvaste tanden - 3 gaats - set L+R

MK0A00489 + MK0A00490 - gesmede slijtvaste tanden (L+R)	€ 108
MK0A00431 + MK0A00430 - gesmede slijtvaste tanden (L+R)	€ 182



Tanden met Wolfram Carbide slijtplaat - 3 gaats - set L+R

MK0A00491 + MK0A00492 - met wolfram carbide slijtplaat (L+R)	€ 395
MK0A00455 + MK0A00456 - met wolfram carbide slijtplaat (L+R)	€ 363

PLUS



PLUS

Prijzen van bouten en moeren per set van 10 stuks

	SCOA00018	€ 57,50
	SCOA00023	€ 55,00
	SCOA00028	€ 51,00
	SCOA00179	€ 39,00
	SCOA00024	€ 42,50
	SCOA00123	€ 60,00