

Rotary tillers

Rotary tillers with central transmission and curved or straight blades, stone buriers and foldable Rotary tillers

Rotozappa

Horizontal axis rotor, equipped with helicoidal blades for excellent shredding and burying of herbaceous and other crop residues, on all types of soil.



Rotolama

Horizontal axis rotor, equipped with straight Rotolama blades for an excellent refinement of hard and dry soils previously worked.



Rotopik

Horizontal axis rotor, equipped with almost straight Rotopik blades, which work at the tip ensuring better aggression even on particularly difficult soils.



Inversa

The reverse rotation of the rotor, equipped with helicoidal blades and combined with a sorting grid and a levelling bar, allows the soft and refined soil to be brought back to the surface.



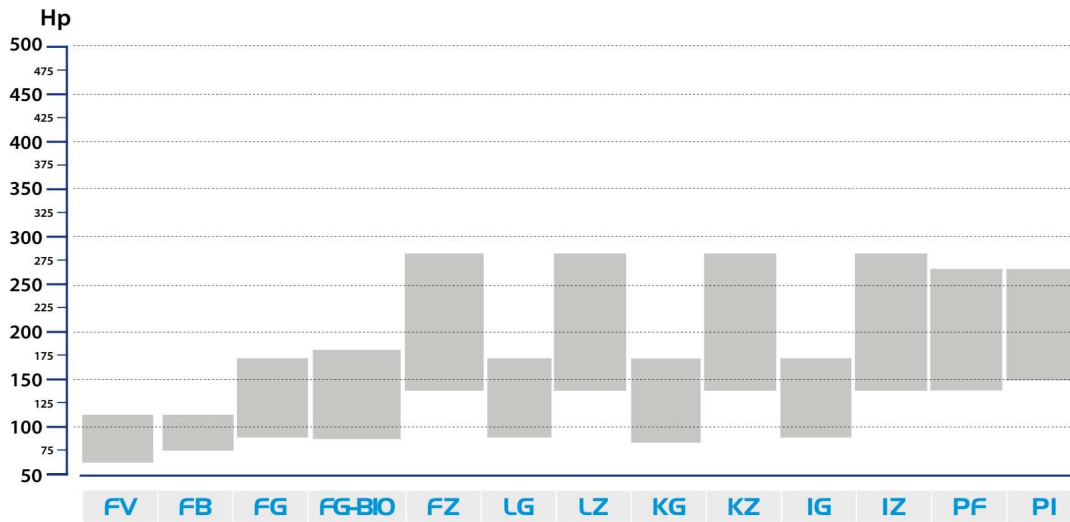

BIO Configuration

Rotor with squared blades suitably inclined to reduce the impact with the soil and obtain an excellent mixing of the organic material.



CENTRAL TRANSMISSION

- The reduced power consumption and the lower weight allow to reduce consumption considerably
- The absence of the lateral transmission guarantees a compact size

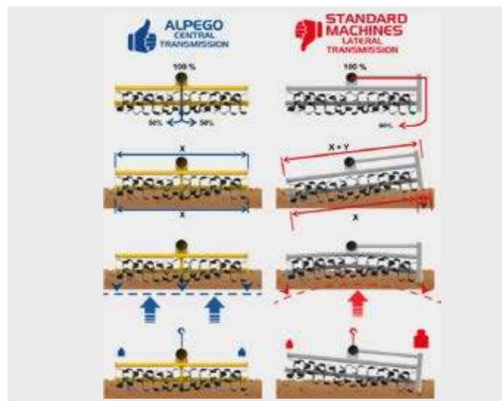

COMMON ICONS

	Tractor power		Overall working width		Overall transport width
	Power take-off P.to.		Gearbox		Roller diameter
	Weight		Product price in Euro		Yokes
	Slip clutch drive shaft		Shear bolt drive shaft		Automatic cam clutch drive shaft

ROTARY TILLERS

	Rotary tiller Rotozappa		Rotary tiller Rotolama		Rotary tiller Rotopik
	Stone-Burrier Inversa		Rotozappa working depth		Rotolama working depth
	Rotopik working depth		Helicoidal blade		Squared blade
	Blade Rotolama		Blade Rotopik		Rotor r.p.m. in Rotozappa
	Rotor r.p.m. in Rotolama		Rotor r.p.m. in Rotopik		Rotor with reversed rotation
	Overall transport width with rollers		Central transmission		

Rotary tillers

Rotary tillers with central transmission and curved or straight blades, stone buriers and foldable Rotary tillers

Frezen met centrale transmissie en gebogen of rechte bladen, overtopfrezen en hydraulisch opklapbare frezen

Rotozappa

Horizontale rotor met L-vormige schoepen.

Uitstekend geschikt voor het hakken en begraven van gras, groenten en andere oppervlakteresten, op elke grondsoort.

Rotolama

Horizontale rotor met rechte bladen.

Uitstekend geschikt voor het bewerken van zeer harde en droge gronden

Rotopik

Horizontale rotor met gedraaide rechte bladen.

De speciale mesjes werken eerst met de punt om optimaal resultaat te garanderen ook in extreem taaie bodems.

Inversa

De omgekeerde rotatie van de rotor, gecombineerd met een sorteerrooster en een nivelleringsbalk, maakt het mogelijk om gewasresten en graszoden onder te werken fijne grond aan de oppervlakte te leggen

BIO-configuratie

Rotor met vierkante bladen voor zeer ondiepe bewerking met als resultaat het mengen van het organische materiaal in de bovenlaag van de grond.

CENTRALE TRANSMISSIE

Het verminderde vermogensbehoefte en het lagere gewicht kunnen het brandstofverbruik aanzienlijk verminderen

De afwezigheid van de zijdelingse overbrenging garandeert compacte afmetingen.



Rotary tiller
Rotozappa
HP 65-120









KENMERKEN

- Rotor met 6 schroefvormig geplaatste bladen
- Centraal geplaatste versnellingsbak in oliebad
- Centrale en laterale mechanische afdichtingselementen in een oliebad
- Frame en "S"-vormige achterkap met 4 veren
- Gereduceerde totale afmetingen
- Stalen frame met hoge treksterkte

STANDAARD UITRUSTING

- 540 RPM versnellingsbak Z=17/19 > 233-291
- Aandrijfjas met slipkoppeling, trekker aftakas 1 3/8 Z=6
- 3-punts hefaankoppeling tractor cat. 2
- Centrale spoorwisser
- Beschikbaar met glijsloffen of rol
- Standaard met gebogen messen - optioneel leverbaar met echte haakse messen (90°)
- Gebogen messen ook verkrijgbaar als wearproof geharde messen

Mod.	 HP	 mm	 mm	 mm	 (n°)	 (n°)	 Kg
FV 140	65-120	1261	1367	220	6	15+15+3+3	490
FV 150	70-120	1379	1485	220	6	18+15+3	500
FV 160	70-120	1496	1602	220	6	18+18	510

Veel voorkomende uitvoeringen

Incl. aftakas met slipkoppeling

	Met glijsloffen	Met kooirol	Met pakkerwals
FV-140	€ 9.390	€ 10.890	€ 11.910
FV-150	€ 9.490	€ 11.230	€ 12.140
FV-160	€ 9.640	€ 11.380	€ 12.530

Opties :

Dubbele flenzen	per flens	€ 118
Haakse messen	per stuk	€ 12
Gebogen messen - wearproof	per stuk	€ 35

Overige opties vermeld achter in de prijslijst

Rotary tiller
Rotozappa
HP 75-120









KENMERKEN

- Rotor met 6 schroefvormig geplaatste bladen
- Centraal geplaatste versnellingsbak in oliebad
- Centrale en laterale mechanische afdichtingselementen in een oliebad
- Frame en "S"-vormige achterkap met 4 veren
- Gereduceerde totale afmetingen
- Stalen frame met hoge treksterkte

STANDAARD UITRUSTING

- 540 RPM versnellingsbak Z=17/19 > 233-291
- Aandrijfas met slipkoppeling, trekker aftakas 1 3/8 Z=6
- 3-punts hefaankoppeling tractor cat. 2
- Centrale spoorwisser
- Beschikbaar met glijsloffen of rol
- Standaard met gebogen messen - optioneel leverbaar met echte haakse messen (90°)
- Gebogen messen ook verkrijgbaar als wearproof geharde messen

Mod.	 HP	 mm	 mm	 mm	 (n°)	 (n°)	 Kg
FB 180	75-120	1730	1830	220	6	18+18	540
FB 205	80-120	1910	2065	220	8	24+24	585
FB 230	85-120	2200	2290	220	8	24+24	620
FB 250	90-120	2440	2535	220	10	30+30	670

Veel voorkomende uitvoeringen

Incl. aftakas met slipkoppeling

	Met glijsloffen	Met kooirol	Met pakkerwals
FB-180	€ 9.195	€ 11.250	€ 12.610
FB-205	€ 9.555	€ 11.660	€ 13.110
FB-230	€ 10.055	€ 12.220	€ 14.100
FB-250	€ 10.615	€ 13.060	€ 14.860

Opties :

Dubbele flenzen	per flens	€ 118
Haakse messen	per stuk	€ 12
Gebogen messen - wearproof	per stuk	€ 35

Overige opties vermeld achter in de prijslijst

Rotary tiller
Rotozappa
HP 90-170









KENMERKEN

- Rotor met 6 schroefvormige geplaatste bladen + tegenflens
- Centraal geplaatste versnellingsbak in oliebad
- Centrale en laterale mechanische afdichtingselementen in een oliebad
- Frame en "S"-vormige achterkap met 4 veren
- Gereduceerde totale afmetingen
- Stalen frame met hoge treksterkte

STANDAARD UITRUSTING

- 540 RPM versnellingsbak Z=28/26 > 216-186
- 3-punts hefaankoppeling tractor cat. 2
- Centrale spoorwisser
- Beschikbaar met glijlofften of rol
- Standaard met gebogen messen - optioneel leverbaar met echte haakse messen (90°)
- Gebogen messen ook verkrijgbaar als wearproof geharde messen

Mod.	 HP	 mm	 mm	 mm	 (n°)	 (n°)	 Kg
FG 250	90-170	2440	2515	240	10	30+30	910
FG 300	100-170	2910	3000	240	12	36+36	960

Veel voorkomende uitvoeringen
Incl. aftakas met slipkoppeling (Walterscheid)

	Met glijlofften	Met kooirol	Met PK-3 pakkerwals
FG-250-E	€ 13.545	€ 16.240	€ 18.040
FG-300-E	€ 14.195	€ 17.010	€ 19.110

Opties :

Aftakas met nokkenskoppeling - meerprijs	€	460
Hydraulische hefinrichting	€	4.620
Doorgaande aftakas (max. 10 kW)	€	540
Verlichting (alleen i.c.m. rol)	€	1.050
Sporenwissers - per paar	€	682
Haakse messen	per stuk	€ 12
Gebogen messen - wearproof	per stuk	€ 35

De FG-serie is ook verkrijgbaar in frontuitvoering.

Overige opties vermeld achter in de prijslijst

FG-BIO



Rotary tiller
Rotozappa
HP 90-180



KENMERKEN







Rotor BIO met 6 vierkante bladen
Centraal geplaatste versnellingsbak in oliebad

Versnellingsbak voor hogere motortoerentallen, een van de hoogste in de categorie, optioneel tot 400 tpm
Verstelbare achterklep om een goed mulchbed te krijgen

Instelbare werkdiepte met nauwkeurige spindelverstelling van de wielen
Gereduceerde totale afmetingen
Stalen frame met hoge treksterkte

STANDAARD UITRUSTING

1000 RPM versnellingsbak Z=25/29 > 320
Verlengd frame met cat. 2 & cat.3 hefaankoppeling tractor
Rotor met versterkende tegenflenzen
Hydraulische afstelling van de achterklep
Verlengde zijplaten
Twee paar luchtbanden (23x10,5 - 12 8PR)
Standaard haakse messen 90°

Mod.	 HP	 mm	 mm	 mm	 (n°)	 (n°)	 Kg
FG BIO 250	90-180	2440	2515	100	10	30+30	1300
FG BIO 300	100-180	2910	3000	100	12	36+36	1340

Description	Kg	€
FG BIO 250 + Automatic cam clutch drive shaft	1335	20.340
FG BIO 300 + Automatic cam clutch drive shaft	1415	21.250

Overige opties vermeld achter in de prijslijst

Rotary tiller
Rotozappa
HP 140-280









KENMERKEN

- Rotor met 6 schroefvormig geplaatste blzden + tegenflens
- Centraal geplaatste versnellingsbak in oliebad
- Centrale en laterale mechanische afdichtingselementen in een oliebad
- Rol gemonteerd op een parallellogram
- Frame en "S"-vormige achterkap met 4 veren
- Gecentraliseerd afstelsysteem achterkap
- Gereduceerde totale afmetingen
- Stalen frame met hoge treksterkte

STANDAARD UITRUSTING

- 1000 RPM versnellingsbak Z=25/29 > 232-313
- 3-punts hefaankoppeling tractor cat. 3, beweegbaar
- Centrale spoorwisser
- Standaard met gebogen messen - optioneel leverbaar met echte haakse messen (90°)
- Gebogen messen ook verkrijgbaar als wearproof geharde messen

Mod.	 HP	 mm	 mm	 mm	 (n°)	 (n°)	 Kg
FZ 300	140-280	2930	3015	250	12	33+33	1440
FZ 360	150-280	3635	3719	250	14	42+42	1580
FZ 400	160-280	4020	4104	250	16	48+48	1730

Veel voorkomende uitvoeringen :

Incl. aftakas met nokkenskoppeling

	Met glijsloffen	Met kooirol G5	Met pakkerwals PK5
FZ-300	€ 21.035	€ 23.680	€ 25.460
FZ-360	€ 22.505	-	€ 28.700
FZ-400	€ 23.655	€ 27.520	€ 30.160

Opties :

Hydraulische hefinrichting		€ 4.620
Doorgaande aftakas (max. 10 kW)		€ 540
Verlichting (alleen i.c.m. rol)		€ 1.050
Sporenwissers - per paar		€ 590
Haakse messen	per stuk	€ 12
Gebogen messen - wearproof	per stuk	€ 35

De FZ-serie is ook verkrijgbaar in frontuitvoering.

FZ

NEW VERSION



Rotary tiller
Rotozappa
HP 140-280



KENMERKEN

- Rotor met 6 schroefvormig geplaatste blzden + tegenflens
- Centraal geplaatste versnellingsbak in oliebad
- Centrale en laterale mechanische afdichtingselementen in een oliebad
- Rol gemonteerd op een parallelogram
- Frame en "S"-vormige achterkap met 4 veren
- Gecentraliseerd afstelsysteem achterkap
- Gereduceerde totale afmetingen
- Stalen frame met hoge treksterkte

STANDAARD UITRUSTING

- 1000 RPM versnellingsbak Z=25/29 > 232-313
- 3-punts hefaankoppeling tractor cat. 3, beweegbaar
- Centrale spoorwisser
- Standaard met gebogen messen - optioneel leverbaar met echte haakse messen (90°)
- Gebogen messen ook verkrijgbaar als wearproof geharde messen
- Uitvoering met glijsloffen heeft een hydraulisch verstelbare klep
- Uitvoering met rol is de klep verbonden met het frame van de rol

Nieuw
Nieuw

Mod.	HP	mm	mm	mm	(n°)	(n°)	Kg
FZ2 300	140-280	2906	3015	250	12	33+33	1315
FZ2 360	150-280	3611	3719	250	14	42+42	1465
FZ2 400	160-280	3996	4104	250	16	48+48	1560

Veel voorkomende uitvoeringen incl. aftakas met slijpkoppeling :

	Met glijsloffen en hydraulisch klep	Met kooirol G5	Met pakkerwals PK5
FZ2-300	€ 20.565	€ 23.280	€ 25.470
FZ2-360	€ 22.035	-	€ 28.300
FZ2-400	€ 23.195	€ 27.120	€ 30.170

Opties :

Aftakas met nokkenskoppeling - meerprijs		€ 410
Hydraulische hefinrichting		€ 4.620
Doorgaande aftakas (max. 10 kW)		€ 540
Verlichting (alleen i.c.m. rol)		€ 1.050
Sporenwissers - per paar		€ 590
Haakse messen	per stuk	€ 12
Gebogen messen - wearproof	per stuk	€ 35

De FZ-serie is ook verkrijgbaar in frontuitvoering.

Overige opties vermeld achter in de prijslijst

Front linkage rotary tillers

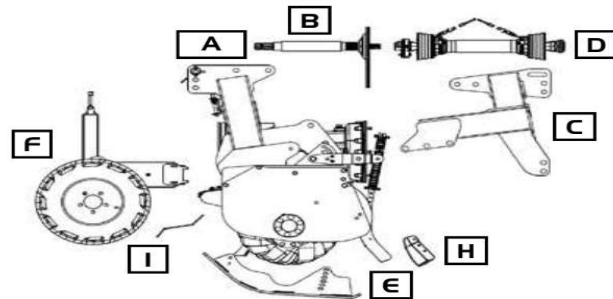

Mod.	HP	mm	mm	mm	(n°)	(n°)	Kg
FG 250	90-170	2440	2515	240	10	30+30	910
FG 300	100-170	2910	3000	240	12	36+36	960
Mod.	HP	mm	mm	mm	(n°)	(n°)	Kg
FZ 300	140-280	2930	3015	250	12	33+33	1440
FZ 360	150-280	3635	3719	250	14	42+42	1580

De frontuitvoering voor zowel de FG als de FZ serie bestaat uit de volgende componenten :

Een standaard FG of FZ frees zonder rol en opties (A)
 Doorgaande aftakas uit 1 stuk (B)
 Frontbok (C)
 Lange aftakas met breekboutbeveiliging (D)
 Set glijlofften (E)
 Set dubbele frontwielen met rubberbanden met tractorprofiel (F)

Frontuitvoering FG-250 (incl. set wisseltandwielen voor 1000 tpm)	€	19.135
Frontuitvoering FG-300 (incl. set wisseltandwielen voor 1000 tpm)	€	19.835

Frontuitvoering FZ-300 (standaard 1000 tpm)	€	25.725
Frontuitvoering FZ-360 (standaard 1000 tpm)	€	27.195

Minderprijzen

2 stel dubbele stalen wielen i.p.v. rubberbanden	€	-1.275
--	---	--------

**Rotary tiller
Rotolama
HP 75-170**



KENMERKEN

Rotoras, met 4 heavy-duty bladen, verminderde vermogensbehoefte

Centraal geplaatste versnellingsbak in oliebad

Centrale en laterale mechanische afdichtingselementen in een oliebad

Rol gemonteerd op een parallellogram

Frame en "S"-vormige achterkap met 4 veren

Gereduceerde totale afmetingen

Stalen frame met hoge treksterkte







STANDAARD UITRUSTING

1000 RPM versnellingsbak Z=25/29 > 320

Egalisatiebalk bevestigd aan de rol met onafhankelijke afstelling

3-punts hefaankoppeling tractor cat. 2

Centrale spoorwisser

Mod.	 HP	 mm	 mm	 mm	 (n°)	 (n°)	 Kg
LG 250	85-170	2440	2550	240	20	40+40	990
LG 300	95-170	2910	3020	240	24	48+48	1060

Veel voorkomende uitvoeringen :

Incl. aftakas met slipkoppeling

	Met glijsloffen	Met kooirol G4	Met pakkerwals PK3
LG-250	-	€ 16.740	€ 18.540
LG-300	-	€ 17.320	€ 19.420

Opties :

Hydraulische hefinrichting	€	3.684
Doorgaande aftakas (max. 10 kW)	€	540
Verlichting (alleen i.c.m. rol)	€	1.050
Sporenwissers - per paar	€	682
Set frontschijven - diameter 46cm	€	1.720

Overige opties vermeld achter in de prijslijst



**Rotary tiller
Rotolama
HP 140-280**



KENMERKEN

Rotoras, met 4 heavy-duty bladen, verminderde vermogensbehoefte

Centraal geplaatste versnellingsbak in oliebad

Centrale en laterale mechanische afdichtingselementen in een oliebad

Rol gemonteerd op een parallellogram

Frame en "S"-vormige achterkap met 4 veren

Gereduceerde totale afmetingen

Stalen frame met hoge treksterkte

STANDAARD UITRUSTING

1000 RPM versnellingsbak Z=29/25 > 313-232

Egalisatiebalk bevestigd aan de rol met onafhankelijke afstelling

3-punts hefaankoppeling tractor cat. 3, beweegbaar

Centrale sporenwisser

Mod.	HP	mm	mm	mm	(n°)	(n°)	Kg
LZ 300	140-280	2930	3015	250	22	44+44	1420
LZ 400	160-280	4020	4104	250	32	64+64	1750

Veel voorkomende uitvoeringen :

Incl. aftakas met slipkoppeling

	Met glijsloffen	Met kooirol G5	Met pakkerwals PK5
LZ-300	-	€ 24.080	€ 26.270
LZ-400	-	€ 28.070	€ 30.710

Opties :

Aftakas met nokkenkoppeling	€ 410
Hydraulische hefinrichting	€ 3.684
Doorgaande aftakas (max. 10 kW)	€ 540
Verlichting (alleen i.c.m. rol)	€ 1.050
Sporenwissers - per paar	€ 590

Overige opties vermeld achter in de prijslijst

Rotary tiller
Rotopik
HP 85-170



KENMERKEN

Rotoras, met 4 heavy-duty bladen, verminderde vermogensbehoefte

Centraal geplaatste versnellingsbak in oliebad

Centrale en laterale mechanische afdichtingselementen in een oliebad

Rol gemonteerd op een parallellogram

Frame en "S"-vormige achterkap met 4 veren

Gereduceerde totale afmetingen

Stalen frame met hoge treksterkte







STANDAARD UITRUSTING

1000 RPM versnellingsbak Z=25/29 > 320

Egalisatiebalk bevestigd aan de rol met onafhankelijke afstelling

3-punts hefaankoppeling tractor cat. 2

Centrale spoorwisser

Mod.	 HP	 mm	 mm	 mm	 (n°)	 (n°)	 Kg
KG 250	85-170	2440	2550	240	20	40+40	990
KG 300	95-170	2910	3020	240	24	48+48	1040

Veel voorkomende uitvoeringen :

Incl. aftakas met slipkoppeling

	Met glijsloffen	Met kooirol G4	Met pakkerwals PK3
KG-250	-	€ 17.100	€ 18.900
KG-300	-	€ 17.820	€ 19.920

Opties :

Hydraulische hefinrichting	€ 3.684
Doorgaande aftakas (max. 10 kW)	€ 540
Verlichting (alleen i.c.m. rol)	€ 1.050
Sporenwissers - per paar	€ 682
Set frontschijven - diameter 46cm	€ 1.720

Overige opties vermeld achter in de prijslijst

KZ



Rotary tiller Rotopik HP 140-280



KENMERKEN

- Rotoras, met 4 heavy-duty bladen, verminderde vermogensbehoefte absorptie
- Centraal geplaatste versnellingsbak in oliebad
- Centrale en laterale mechanische afdichtingselementen in een oliebad
- Rol gemonteerd op een parallellogram
- Frame en "S"-vormige achterkap op 4 veren
- Gereduceerde totale afmetingen
- Stalen frame met hoge treksterkte

STANDAARD UITRUSTING

- 1000 RPM versnellingsbak Z=29/25 > 313-232
- Egalisatiebalk bevestigd aan de rol met onafhankelijke afstelling
- 3-punts hefaankoppeling tractor cat. 3, beweegbaar
- Centrale spoorwisser

Mod.	HP	mm	mm	mm	(n°)	(n°)	Kg
KZ 300	140-280	2930	3015	250	22	44+44	1490
KZ 400	160-280	4020	4104	250	32	64+64	1750

Veel voorkomende uitvoeringen :
Incl. aftakas met slipkoppeling

	Met glijsloffen	Met kooirol G5	Met pakkerwals PK5
KZ-300	-	€ 25.190	€ 27.380
KZ-400	-	€ 29.230	€ 31.870

Opties :

Aftakas met nokkenkoppeling	€ 410
Hydraulische hefinrichting	€ 3.684
Doorgaande aftakas (max. 10 kW)	€ 540
Verlichting (alleen i.c.m. rol)	€ 1.050
Sporenwissers - per paar	€ 590

Overige opties vermeld achter in de prijslijst

Stone burier HP 75-170











IG OVERTOPFREES - voor lichte grondsoorten

KENMERKEN

- Roterende rotor met 6 zware tanden + tegenflens
- Centraal geplaatste versnellingsbak in oliebad
- Centrale en laterale mechanische afdichtingselementen in een oliebad
- Boxframe met gebogen bodem en met ondersteuningsbalken
- Nivelleerbare achterklep, gecombineerd met verstelbare achterrol, met spindelversteling
- Verstelbare en schokabsorberende Rock Comb
- Speciaal spijlenrek met twee rijen, met mogelijkheid om er een rij uit te halen (voor of achter)
- Verlengde zijplaten

STANDAARD UITRUSTING

- 1000 RPM versnellingsbak Z=21/33 > 237
- 3-punts hefaankoppeling tractor cat. 2
- Centrale spoorwisser
- Achterrol aansluitplaten met een systeem voor snelle instelling van de werkdiepte
- Standaard met gebogen messen - optioneel leverbaar met echte haakse messen (90°)
- Gebogen messen ook verkrijgbaar als wearproof geharde messen

Mod.	 HP	 mm	 mm	 mm	 mm	 (n°)	 (n°)	 (n°)	 Kg
IG 250	90-170	2440	2550	540	240	10	30+30	46	1040
IG 300	100-170	2910	3020	540	240	12	36+36	56	1260

Veel voorkomende uitvoeringen : Incl. aftakas met slipkoppeling

		Met kooirol G4	Met pakkerwals PK3
IG-250		€ 19.490	€ 20.290
IG300		€ 20.170	€ 22.270

Opties :

Aftakas met nokkenkoppeling - meerprijs		€ 940
Hydraulische hefinrichting (1)		-
Doorgaande aftakas (max. 10 kW)		-
Verlichting (alleen i.c.m. rol)		€ 1.050
Haakse messen	per stuk	€ 12
Gebogen messen - wearproof	per stuk	€ 35

(1) - vraag naar de mogelijkheden i.v.m. aanpassingen

Overige opties vermeld achter in de prijslijst

Stone burier HP 140-280











IZ OVERTOPFREES - voor lichte en zwaardere grondsoorten

KENMERKEN

- Roterende rotor met 6 zware tanden + tegenflens
- Centraal geplaatste versnellingsbak in oliebad
- Centrale en laterale mechanische afdichtingselementen in een oliebad
- Boxframe met gebogen bodem en met ondersteuningsbalken
- Nivelleerbare achterklep, gecombineerd met verstelbare achterrol, met spindelverstelling
- Verstelbare en schokabsorberende Rock Comb
- Speciaal spijlenren met twee rijen, met mogelijkheid om er een rij uit halen (voorste of achterste)
- Verlengde zijplaten

STANDAARD UITRUSTING

- 1000 RPM versnellingsbak Z=25/29 > 232-313
- 3-punts hefaankoppeling tractor cat. 3, mee bewegend
- Centrale spoorwisper
- Standaard met gebogen messen - optioneel leverbaar met echte haakse messen (90°)
- Gebogen messen ook verkrijgbaar als wearproof geharde messen

Mod.	 HP	 mm	 mm	 mm	 mm	 (n°)	 (n°)	 (n°)	 Kg
IZ 300	140-280	2930	3015	578	250	12	33+33	56	1690
IZ 360	150-280	3635	3719	578	250	14	42+42	68	1880
IZ 400	160-280	4020	4104	578	250	16	48+48	76	1950

Veel voorkomende uitvoeringen :

Incl. aftakas met slipkoppeling

	Met kooirol G5	Met pakkerwals PK5
IZ-300	€ 27.870	€ 30.060
IZ-360	niet mogelijk	€ 33.440
IZ-400	€ 32.820	€ 35.460

Opties :

Aftakas met nokkenkoppeling - meerprijs	€ 410
Verlichting (alleen i.c.m. rol)	€ 1.050
Haakse messen	per stuk € 12
Gebogen messen - wearproof	per stuk € 35

Overige opties vermeld achter in de prijslijst

Foldable Rotary tiller HP 140-260



Opklapbare grondfrees

HP 130-260 / KW 96-192

KENMERKEN

Opklapbaar frame met hydraulische vergrendeling en compacte transportstand breedte voor wegverkeer (max 2,45 mt)

Dubbele centrale transmissie met tandwiel in oliebad

Centrale en laterale mechanische afdichtingselementen in een oliebad + tank

Rol gemonteerd op een parallellogram

Dubbele veiligheid bij zijwaartse overbrenging

Hydraulisch ontgrendelingssysteem van veiligheidshaken

Blokkerende mechanische veiligheidshaak voor transport

Achterkap met "S" -vorm met nieuw antischokstelsel met elastische armen

Verstelbare kap

STANDAARD UITRUSTING

Rotor met 6 schroefvormige geplaatste bladen + tegenflens

N.B.: De schroefvormige bladen naast de twee middelste transmissie zijn in een WEAR-PROOF uitvoering (6 dx + 6 sx).

1000 RPM versnellingsbak Z=30/24 > 218

Centrale aandrijf-as 1 3/8 Z=6

Zijdelingse aandrijfassen met slipkoppeling

Transmissie met 3 versnellingen

3-punts hef aankoppeling cat. 3 en cat. 4, meebewegend

Achterborden met verlichting

Centrale spoorwiser

Standaard met gebogen messen - optioneel leverbaar met echte haakse messen (90°)

Gebogen messen ook verkrijgbaar als wearproof geharde messen

NB: PF-360 Alleen beschikbaar met PK3-rol

Voor "Heavy Duty" gebruik en vermogen boven de 200 pk wordt een oliekoeler op de centrale aandrijving aanbevolen (SB0A00007)







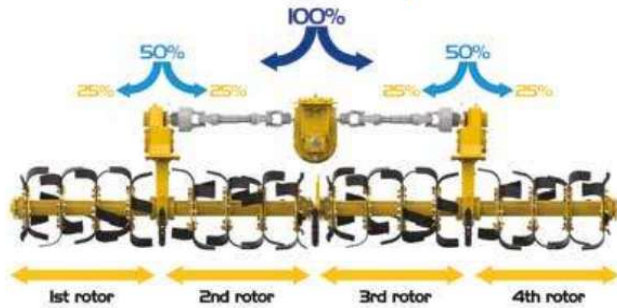

POKER



Foldable Rotary tiller
HP 140-260



Mod.	 Packer	 Spiral	 Spike	 Cage
PF4 360	PK3	-	-	-
PF4 400	PK3 / PK5	SP3 / SP5	P41 / P5	G4 / G5
PF4 460	PK3	SP3	P41	G4
PF4 500	PK3 / PK5	SP3 / SP5	P41 / P5	G4 / G5

Mod.	 HP	 mm	 mm	 mm	 mm	 mm	 (n°)	 (n°)	 Kg
PF4 360	140-260	2400	3720	3660	240	540	16	48+48	2150
PF4 400	150-260	2400	4051	3995	240	540	16	48+48	2200
PF4 460	160-260	2400	4525	4462	240	540	20	60+60	2360
PF4 500	170-260	2400	4995	4940	240	540	20	60+60	2420

Veel voorkomende uitvoeringen :

Incl. zijdelingse aftakassen met slipkoppeling

	Met kooirol G4	Met kooirol G5	Met pakkerwals PK3	Met pakkerwals PK5
PF-360	-	-	€ 39.990	-
PF-400	-	€ 39.640	-	€ 42.950
PF-460	€ 43.290	-	€ 43.290	-
PF-500	-	€ 42.790	€ 44.700	€ 46.210

Opties :

Zijdelingse aftakassen met nokkenskoppeling	Meerprijs	€ 450
Oliekoeler op de centrale aandrijving		€ 1.910
Haakse messen	Per stuk	€ 12
Gebogen messen - wearproof	Per stuk	€ 35

Overige opties vermeld achter in de prijslijst

Foldable Stone burier HP 150-260



Opklapbare overtopfrees

HP 130-260 / KW 96-192

KENMERKEN

Opklapbaar frame met hydraulische vergrendeling en compacte transportstand breedte voor wegverkeer (max 2,45 mt)

Dubbele centrale transmissie met tandwiel in oliebad

Centrale en laterale mechanische afdichtingselementen in een oliebad + tank

Rol gemonteerd op een parallellogram

Dubbele veiligheid bij zijwaartse overbrenging

Hydraulisch ontgrendelingssysteem van veiligheidshaken

Blokkerende mechanische veiligheidshaak voor transport

Achterkap met "S"-vorm met nieuw antischokstelsel met elastische armen

Schokabsorberende spijlenrek traploos verstelbaar

Speciaal spijlenrek met 2 rijen, configureerbaar in enkele rij (voor of achter)

Verhoogde zijplaten

STANDAARD UITRUSTING

Rotor met 6 schroefvormige geplaatste bladen + tegenflens

1000 RPM versnellingsbak Z=31/23 > 235

Centrale aandrijf-as 1 3/8 Z=6

Zijdelingse aandrijfassen met slipkoppeling

Transmissie met 3 versnellingen

3-punts hefaankoppeling tractor cat. 3 en Cat. 4N, meebewegend

Achterborden met verlichting

Centrale spoorwiser

Standaard met gebogen messen - optioneel leverbaar met echte haakse messen (90°)

Gebogen messen ook verkrijgbaar als wearproof geharde messen







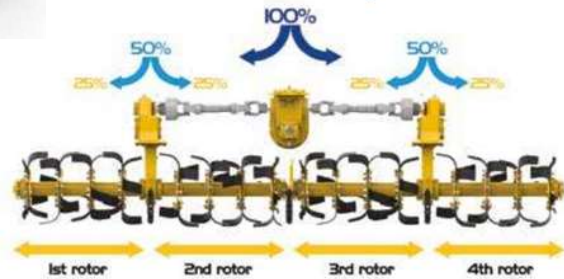

Voor "Heavy Duty" gebruik en vermogen boven de 200 pk wordt een oliekoeler op de centrale aandrijving aanbevolen (SB0A00007)

POKER INVERSA

Foldable Stone burier
HP 150-260



Mod.	 Packer	 Spiral	 Spike	 Cage
PI2 360	PK3	-	-	-
PI2 400	PK3 / PK5	SP3 / SP5	P41 / P5	G4 / G5
PI2 460	PK3 / PK5	SP3 / SP5	P41 / P5	G4 / G5
PI2 500	PK3 / PK5	SP3 / SP5	P41 / P5	G4 / G5

Mod.	 HP	 mm	 mm	 mm	 mm	 mm	 (n°)	 (n°)	 Kg
PI2 360	150-260	2400	3720	3660	240	540	16	48+48	2460
PI2 400	160-260	2400	4051	3995	240	540	16	48+48	2510
PI2 460	170-260	2400	4525	4462	240	540	20	60+60	2700
PI2 500	180-260	2400	4995	4940	240	540	20	60+60	2790

Veel voorkomende uitvoeringen :

Incl. aftakassen met nokkenskoppeling (uitzondering PI-360)

	Met kooirol G4	Met kooirol G5	Met pakkerwals PK3	Met pakkerwals PK5
PI-360	-	-	€ 44.630	-
PI-400	€ 42.990	€ 44.560	€ 45.890	€ 47.760
PI-460	€ 44.980	-	€ 48.740	-
PI-500	-	€ 48.010	€ 49.800	€ 51.430

Opties :

Oliekoeler op de centrale aandrijving		€ 1.910
Haakse messen	Per stuk	€ 12
Gebogen messen - wearproof	Per stuk	€ 35

Overige opties vermeld achter in de prijslijst

Optionals

The right accessory for every situation



Code	Classif.	Description	Mod.	Q.ty	Kg	€
S85A00053 ⁽¹⁾	C	Lateral extensions gate	FB	x 1	4	82
			FG	x 1		

⁽¹⁾ Only for machine with skids



Code	Classif.	Description	Mod.	Q.ty	Kg	€
TCGA00018	C	Counterflange kit	FV 140	x 4	5	118
			FV 150	x 5		
			FV 160	x 6		
			FB 180	x 6		
			FB 205	x 8		
			FB 230	x 8		
FB 250	x 10					

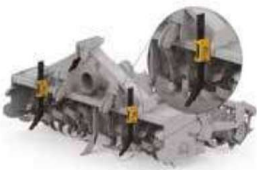

Code	Classif.	Description	Mod.	Q.ty	Kg	€
S91A00009 + C10A04170	C	Track eraser pair	FG 250	x 1	45	652
		Track eraser protection	LG 250 KG 250	x 2	2	
S91A00009 + C10A04171	C	Track eraser pair	FG 300	x 1	45	682
		Track eraser protection	LG 300 KG 300	x 2	5	
S91A00020	C	Track eraser pair	FZ/LZ/KZ	x 1	42	590
S91A00021	C	Track eraser pair NO-STOP	FZ/LZ/KZ	x 1	70	1.030
S91A00022	C	Track eraser pair	PF	x 1	50	600



Code	Classif.	Description	Mod.	Q.ty	Kg	€
S40A00003 + TCGA00027	A	Hydraulic linkage for seed-drill	LG/KG/ LZ/KZ	x 1	175	3.684
	A	Hydraulic linkage adjustment			+ 11	
S40A00003 + SZ9A00123	A	Hydraulic linkage for seed-drill A2	FG / FZ	x 1	175	4.620
	A	Hydraulic linkage adjustment			+ 95	
SZ9A00016	A	Hydraulic linkage stop switch kit	LG/KG/ LZ/KZ	x 1	5	375



Code	Classif.	Description	Mod.	Q.ty	Kg	€
SASA00080	C	Hydraulic depth adjustment	FZ	x 1	75	1.350
SASA00032			LZ-KZ	x 1	50	1.910
SASA00096 + SASA00097	-	Hydraulic depth adjustment + Hydr. system of hydr. depth adjustment of roller	FG/LG/ KG/IG	x 1	10 + 25	1.114
SASA00095	C	Hydraulic depth adjustment	PF	x 1	30	3.290
SASA00104	-	Hydraulic depth adjustment	PI	x 1	65	2.830



Code	Classif.	Description	Mod.	Q.ty	Kg	€
SA1A00010 ⁽²⁾	A	Kit rear pto 1"3/8 Z=6	FG/LG/KG/ FZ/LZ/KZ/ IZ	x1	12	540

⁽²⁾ Pto maximum power 10 Kw



Code	Classif.	Description	Mod.	Q.ty	Kg	€
SZ9A00108	D	APV assembly kit available on power harrows/rotary tillers	FG/LG/KG/ FZ/LZ/KZ/ IG/IZ	x1	140	1.800



Code	Classif.	Description	Mod.	Q.ty	Kg	€
S85A00066	A	Pair of conveyor discs Ø460 mm	FG/LG/ KG/IG 250-300	x1	100	1.720



Code	Classif.	Description	Mod.	Q.ty	Kg	€
SB0A00007	-	Central gerabox cooling kit	PF / PI	x1	30	1.910

Code	Classif.	Description	Mod.	Q.ty	Kg	€
S45A00086	-	Kit for roller attachment from series 3 to series 5	PF	x1	10	110
S45A00092	-		PI	x1	25	230

Code	Classif.	Description	Mod.	Q.ty	Kg	€
SB1A00032	-	Reflective tables with lights for rigid rotary tillers/stoneburiers	ALL KIND OF ROLLERS	x1	20	1.050











Code	Classif.	Description	Mod.	Q.ty	€
Q25A00126	-	Transport kit 2 pcs.	FB	x1	ON REQUEST

Code	Classif.	Description	Mod.	Q.ty	€
Q25A00166	-	Transport kit 2 pcs.	FG/LG/KG/ FZ/LZ/KZ/ IG/IZ	x1	ON REQUEST

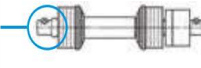
Additional forks and gear pairs

Fork variants and gear pairs supplied separately

YOKES SUPPLIED SEPARATELY

Code	Mod.	Additional fork	Standard fork		Drive shaft	Kg	€
M72A00140	FV	1*3/8 Z=21	1*3/8 Z=6		M70A00182	-	230
M72A00141		1*3/4 Z=6 				-	230
M72A00110		1*3/4 Z=20				2,6	300
M72A00108	FZ LZ KZ IZ	1*3/8 Z=21	1*3/8 Z=6		M70A00193 M70A00033	3	410
M72A00109		1*3/4 Z=6 				2,6	385
M72A00142		1*3/4 Z=20				2,6	355
M72A00108	FG-BIO	1*3/8 Z=21	1*3/8 Z=6		M70A00205	3	410
M72A00109		1*3/4 Z=6 				2,6	385
M72A00142		1*3/4 Z=20				2,6	355
M72A00135	FG LG KG IG	1*3/8 Z=21	1*3/8 Z=6		M70A00184	3,1	225
M72A00054		1*3/4 Z=20 				3,9	270
M72A00053		1*3/4 Z=6				3,9	283
M72A00112	PF PI	1*3/8 Z=21	1*3/8 Z=6		M70A00194	4	620
M72A00113		1*3/4 Z=6 				4	610
M72A00114		1*3/4 Z=20				4	630

N.B: Can be purchased in addition to the standard ones



SPEED TABLE

Code	Classif.			540 rpm	750 rpm	1000 rpm	Kg	€
SA0A00008	FV FB	16/20		208/325	289	385	4	260
SA0A00009 ⁽¹⁾		17/19 ⁽¹⁾		233/291 ⁽¹⁾	323 ⁽¹⁾	431 ⁽¹⁾	3,5	245
SA0A00011		14/26		-	-	259	4,5	390
SA0A00010		15/25		-	-	289	4,5	295

⁽¹⁾ Gears mounted as standard

SPEED TABLE

Code	Classif.			540 rpm	750 rpm	1000 rpm	Kg	€
SA0A00023	FG LG KG IG FG-BIO	19/35		370	-	202	6,5	365
SA0A00023 (FG-BIO)		35/19		370	-	202		365
SA0A00020 ⁽²⁾		21/33 ⁽²⁾		315	-	237 ⁽²⁾	5	440
SA0A00020 (FG-BIO)		33/21		315	-	237		440
SA0A00021		24/30		251	223	297	7,5	425
SA0A00021 (FG-BIO)		30/24		251	-	297		425
SA0A00022 ⁽³⁾		25/29 ⁽³⁾		233 ⁽³⁾	240 ⁽³⁾	320 ⁽³⁾	7	415
SA0A00022 ⁽⁵⁾ (FG-BIO)		29/25 ⁽⁵⁾		233 ⁽⁵⁾	-	320 ⁽⁵⁾		415
SA0A00019 ⁽⁴⁾		28/26 ⁽⁴⁾		216/186 ⁽⁴⁾	300 ⁽⁴⁾	400 ⁽⁴⁾	5	425

⁽²⁾ Gears mounted as standard for models IG. IG available only 540 and 1000 rpm

⁽³⁾ Gears mounted as standard for models LG and KG

⁽⁴⁾ Gears mounted as standard for models FG

⁽⁵⁾ Gears mounted as standard for models FG-BIO. FG-BIO available only 540 and 1000 rpm

SPEED TABLE

Code	Classif.			540 rpm	750 rpm	1000 rpm	Kg	€
SA0A00020	FZ LZ KZ IZ	21/33		-	-	172/424	5	440
SA0A00021		24/30		-	-	216/337	7,5	425
SA0A00022		25/29 ⁽⁶⁾		-	-	232/313 ⁽⁶⁾	7	415
		29/25 ⁽⁷⁾		-	-	313-232 ⁽⁷⁾		
SA0A00019		26/28		-	-	250/290	5	425

⁽⁶⁾ Gears mounted as standard for models FZ and IZ

⁽⁷⁾ Gears mounted as standard for models LZ and KZ

SPEED TABLE

Code	Classif.			540 rpm	750 rpm	1000 rpm	Kg	€
SA0A00028 ⁽⁸⁾	PF	33/21 ⁽⁸⁾		-	-	274 ⁽⁸⁾	7,5	540
SA0A00032		31/23		-	-	235	7,5	530
SA0A00029		30/24		-	-	218	8	540
SA0A00030		29/25		-	-	202	8	540
SA0A00027		28/26		-	-	188	6	505

⁽⁸⁾ Gears mounted as standard

SPEED TABLE

Code	Classif.			540 rpm	750 rpm	1000 rpm	Kg	€
SA0A00032 ⁽⁹⁾	PI	31/23 ⁽⁹⁾		-	-	235 ⁽⁹⁾	7,5	530
SA0A00029		30/24		-	-	218	8	540
SA0A00030		29/25		-	-	202	8	540
SA0A00027		28/26		-	-	188	6	505

⁽⁹⁾ Gears mounted as standard