



**MAXIDRILL**





Fontenay-sur-Eure



Carvin



Châteaubourg



La Conillais



Osasco





**WE ARE** energetic efficiency  
PRECISION **INDUSTRIAL**  
TECHNOLOGY

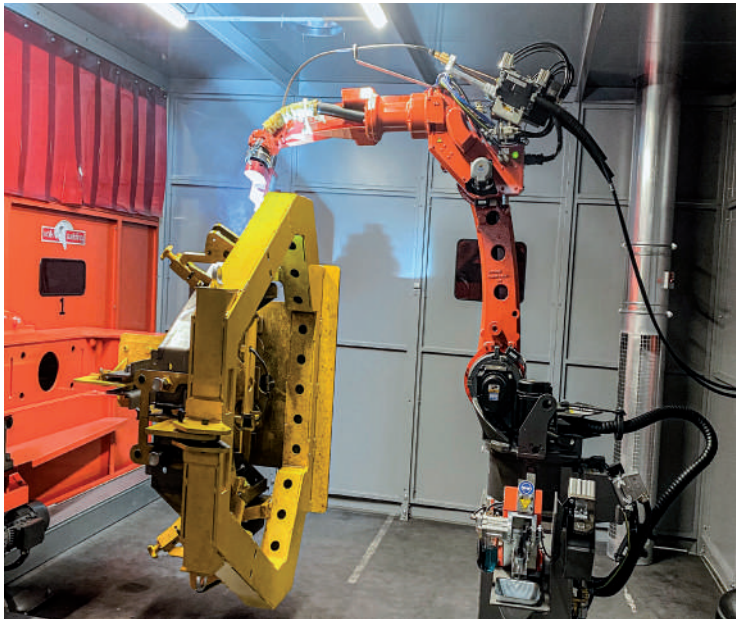



# FARMING TOGETHER

Be positive about Agriculture

*Positez sur l'Agriculture*

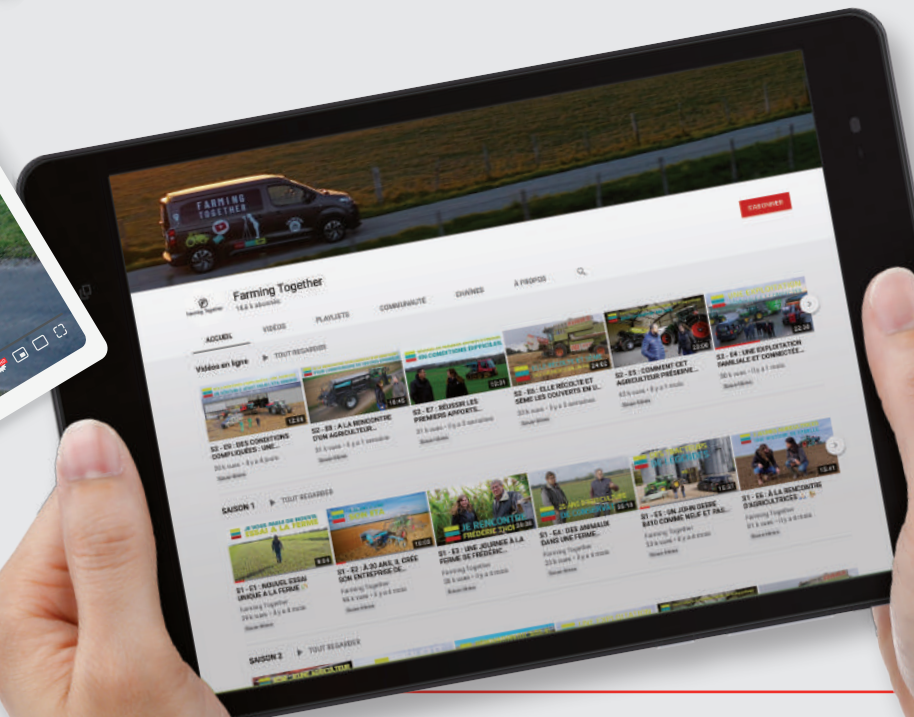
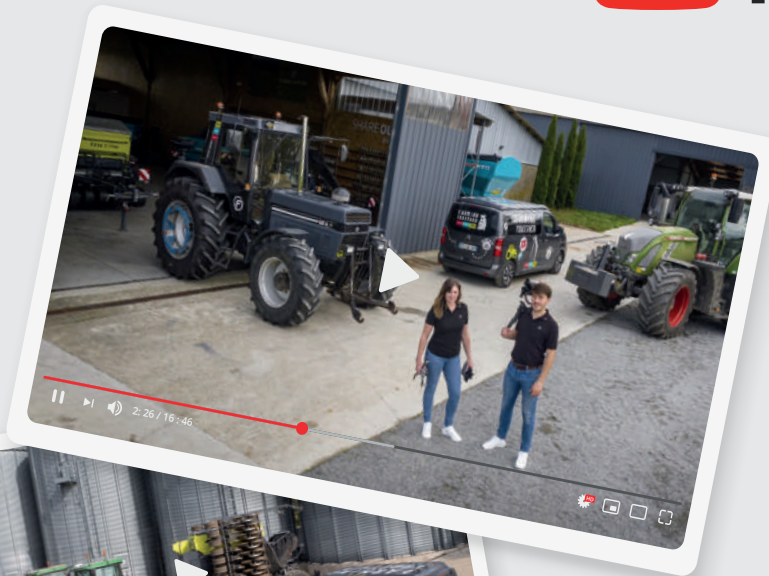



[farming-together.com](https://farming-together.com)









# Fertisem 3020



**3020**



**3020 Pro**



**3020 Fertisem Pro II**



**3020 Fertisem**



**3020 Fertisem Pro I**

---

# Fertisem 4020



**4020**



**4020 Pro**



**4020 Fertisem Pro II**



**4020 Fertisem**



**4020 Fertisem Pro I**

# Fertisem W 4020



**W 4020**



**W 4020 Pro**



**W 4020 Fertisem Pro II**



**W 4020 Fertisem**



**W 4020 Fertisem Pro I**

---

# Fertisem W 6020



**W 6020**



**W 6020 Pro**



**W 6020 Fertisem Pro II**



**W 6020 Fertisem**



**W 6020 Fertisem Pro I**







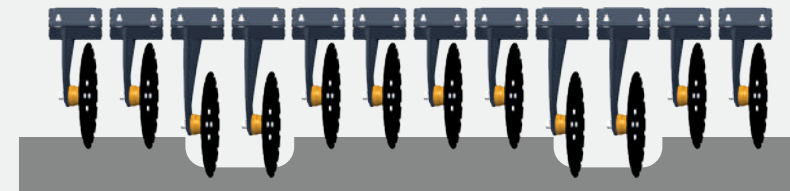
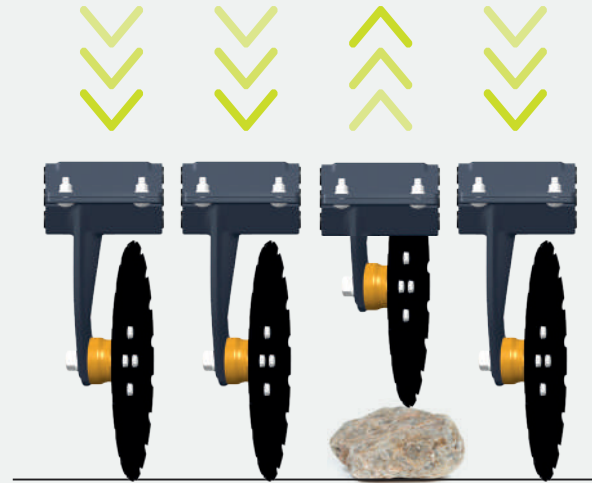
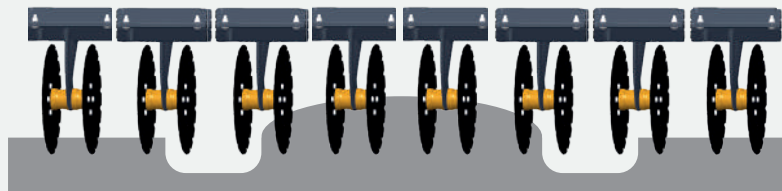
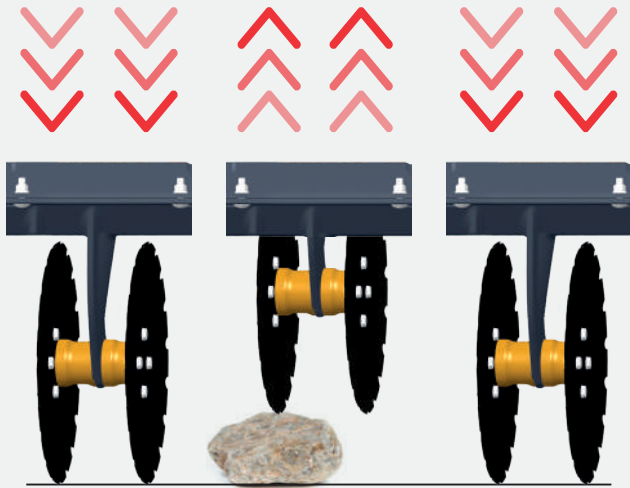









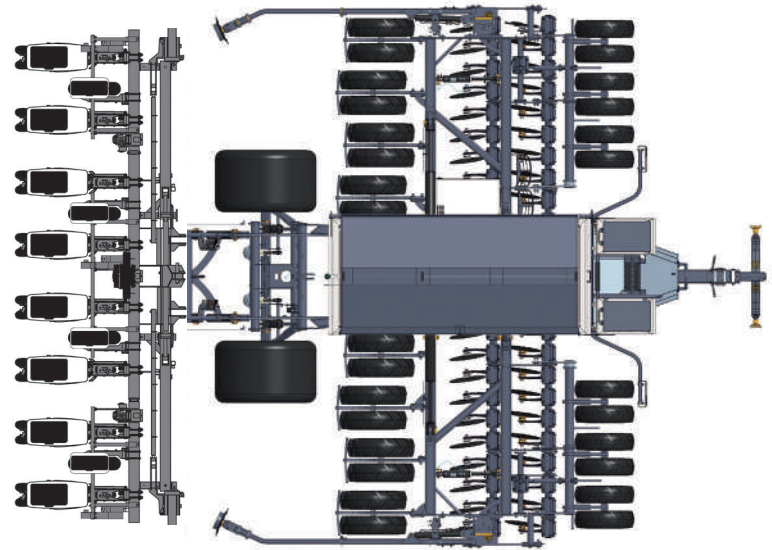
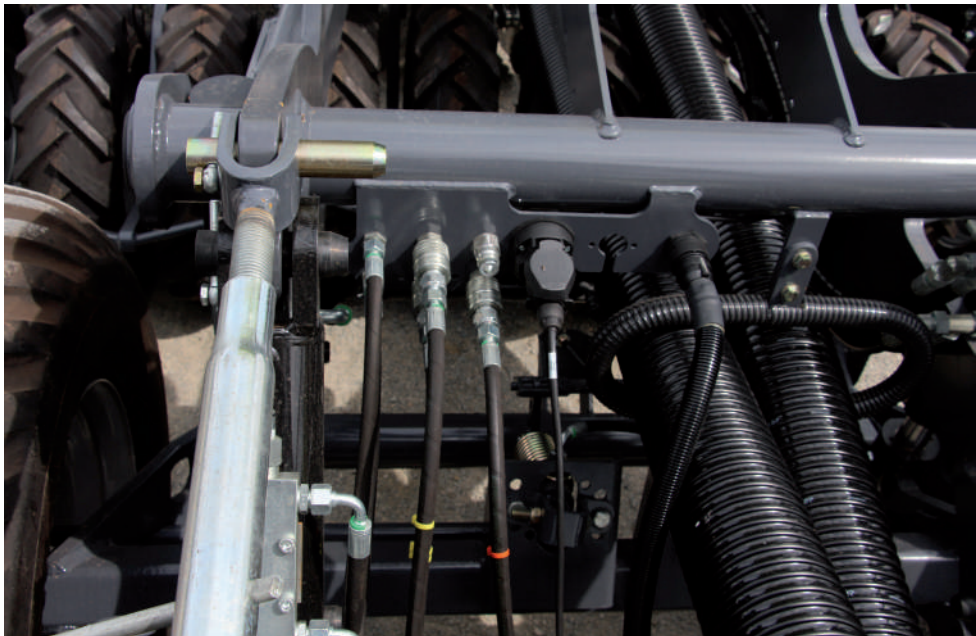
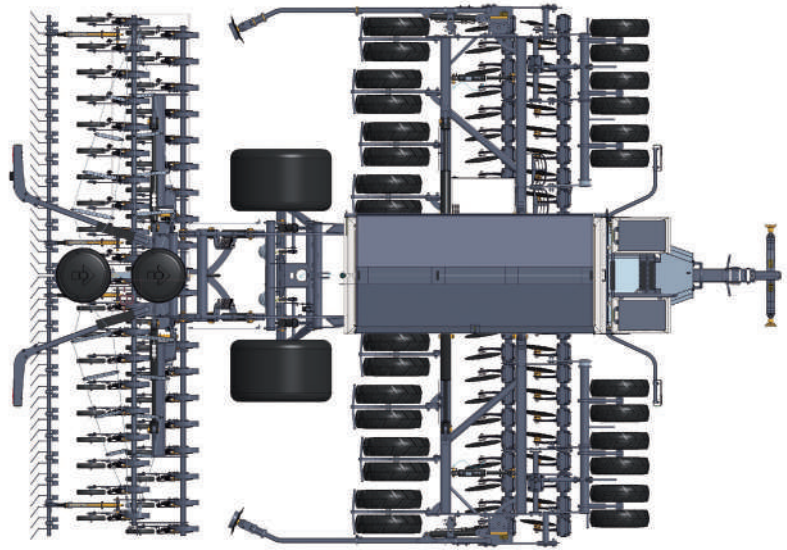

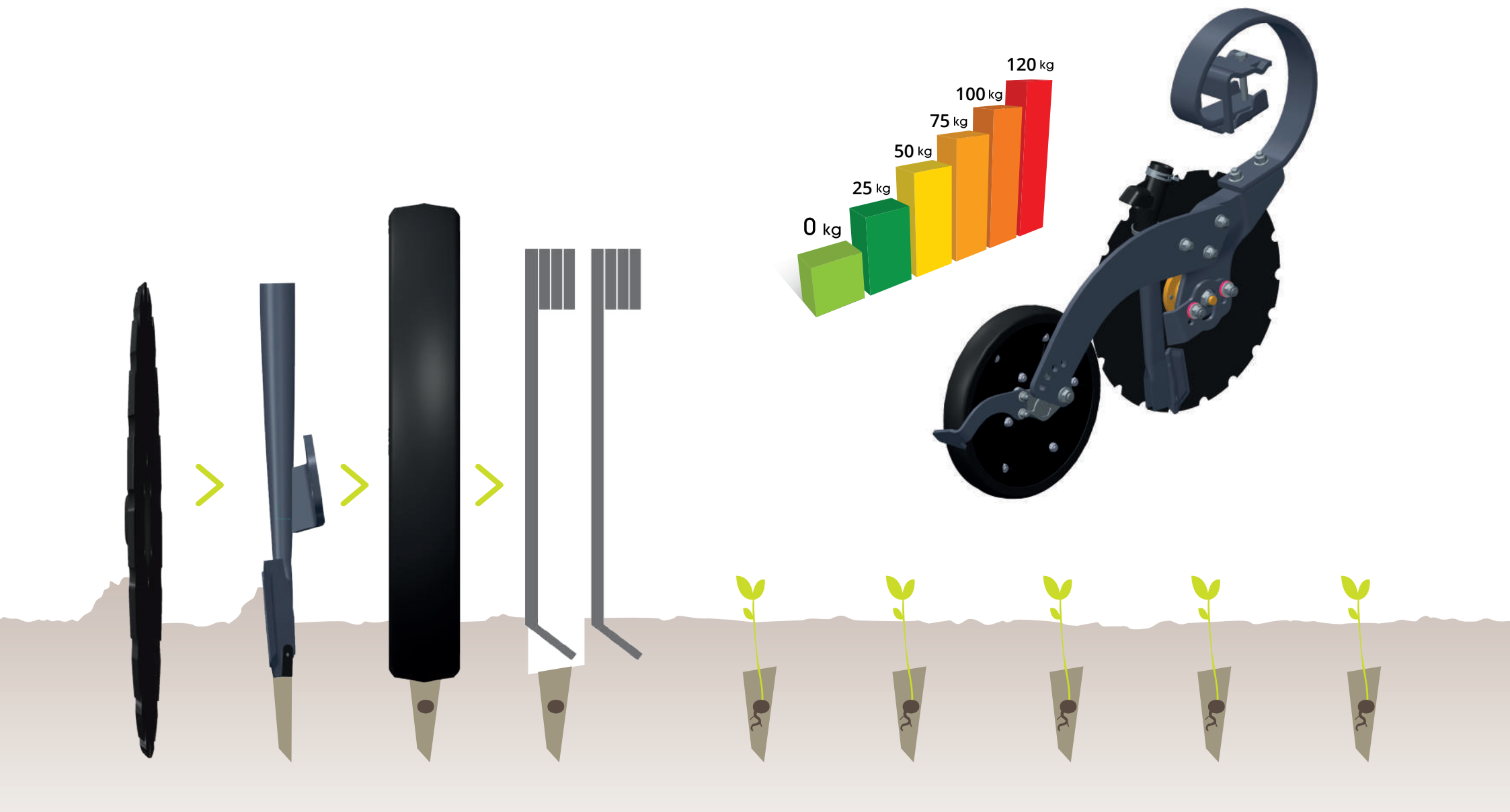



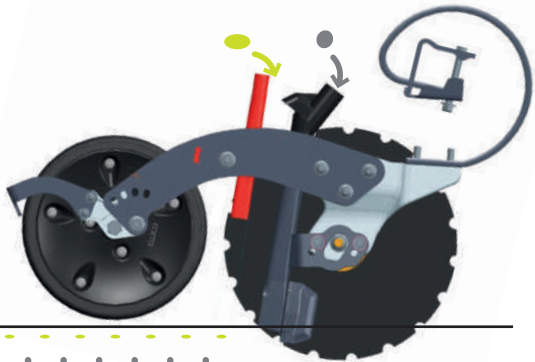
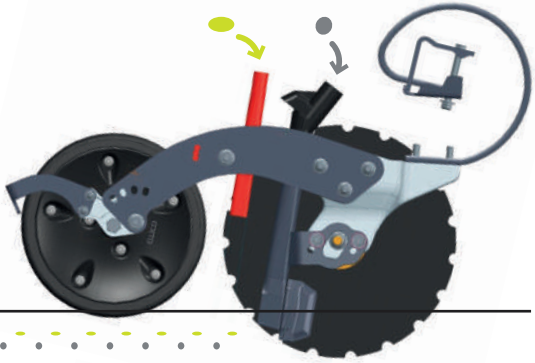
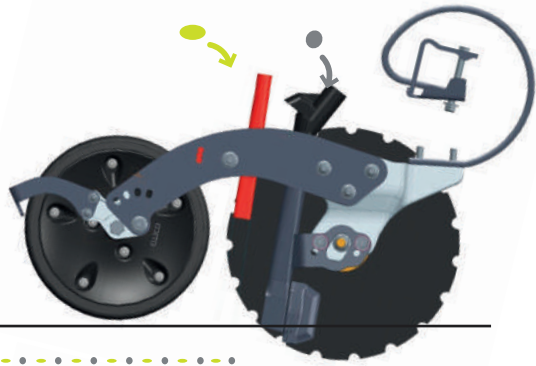



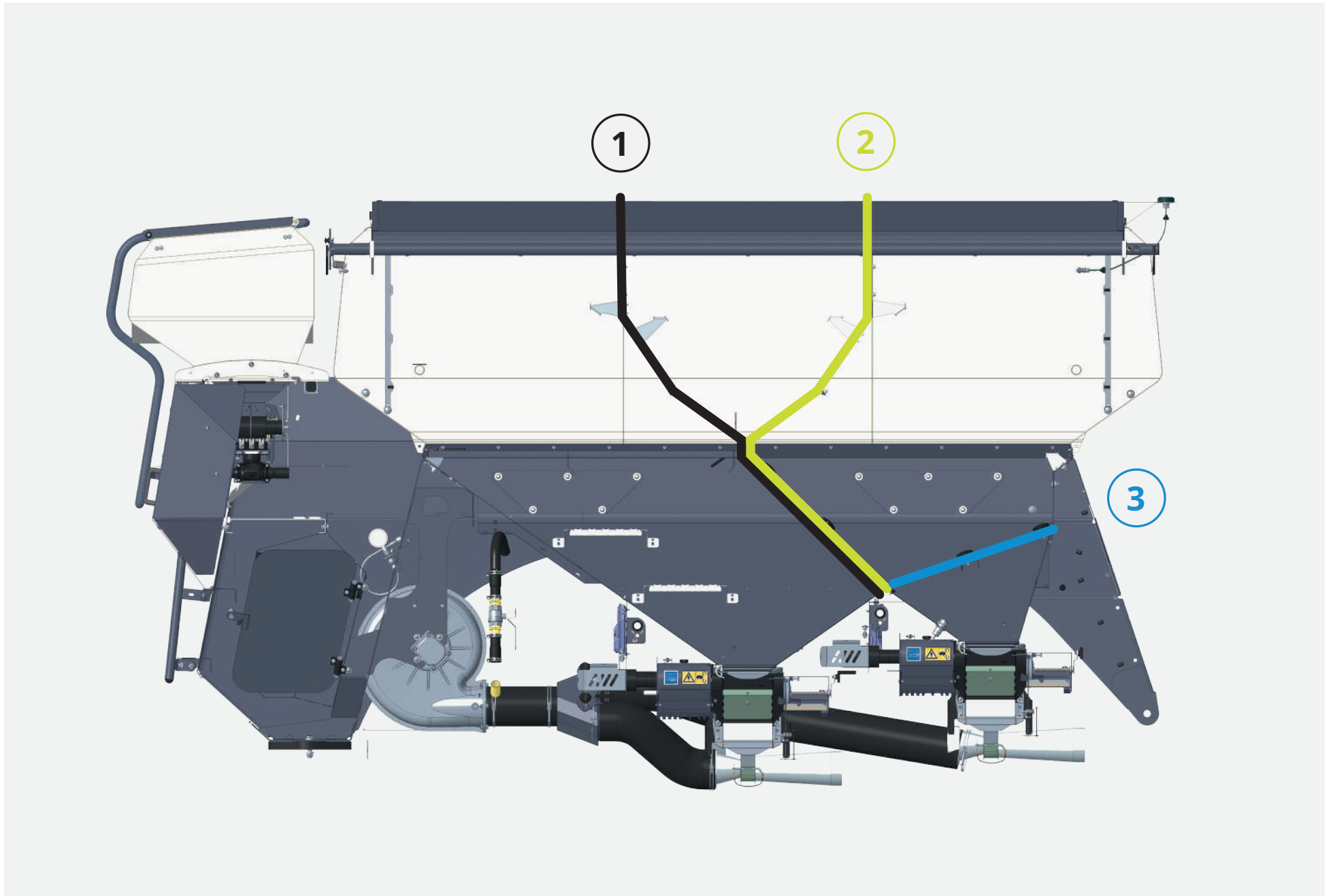





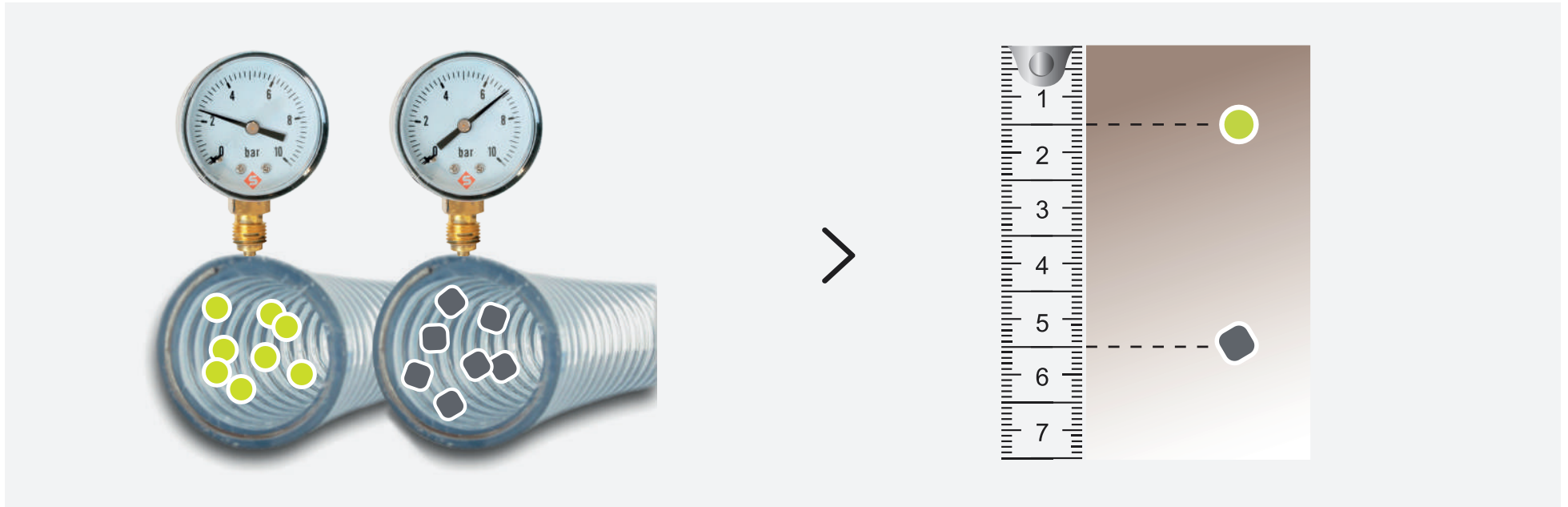

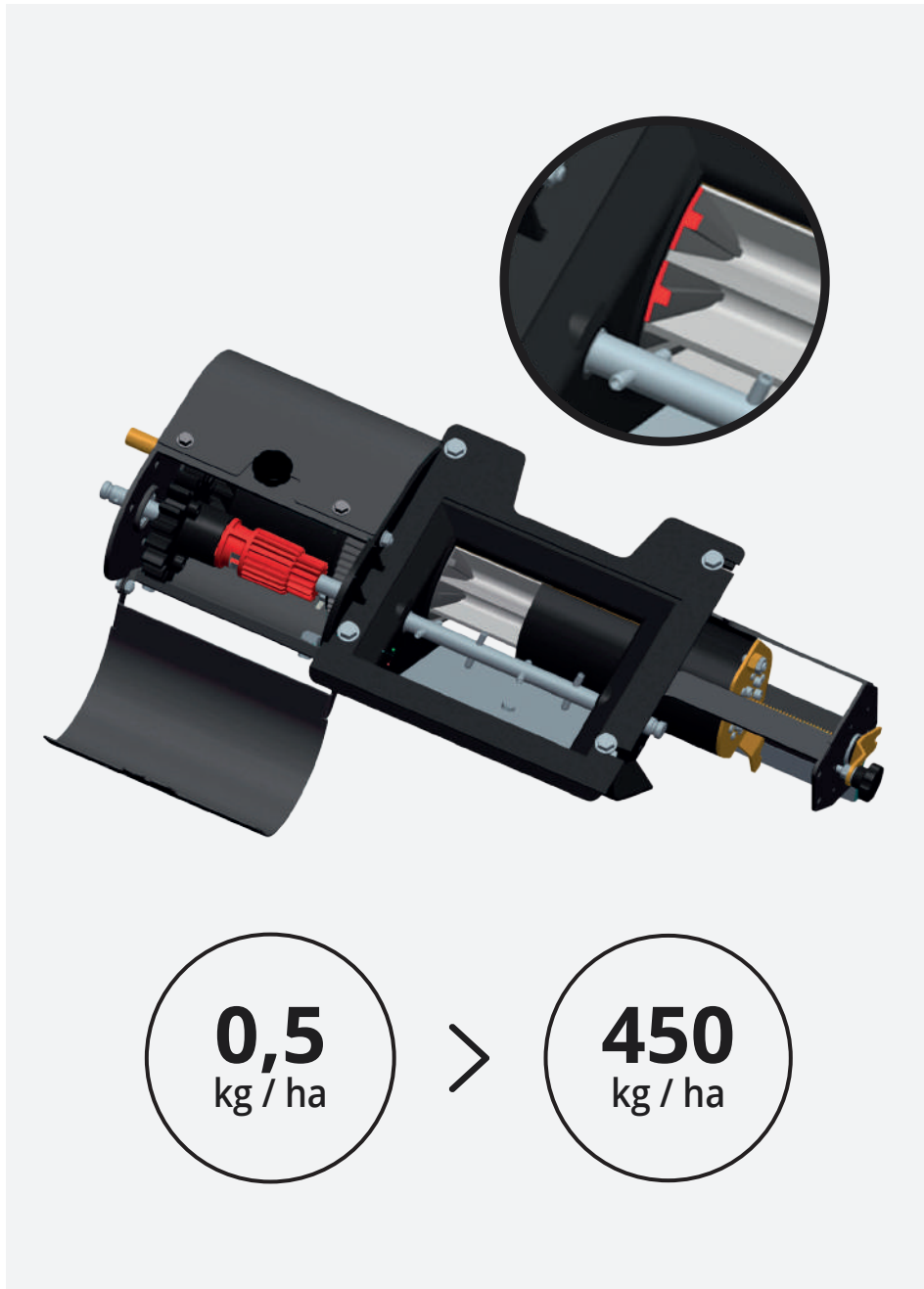







AEF Certified

**ISO BUS**

UT	TECU	AUX-N
TC-BAS	TC-GEO	TC-SC
...	...	...

[www.aef-isobus-database.org](http://www.aef-isobus-database.org)



# E-Drive







**TC-SC**  
Stop & Go

# E-Drive

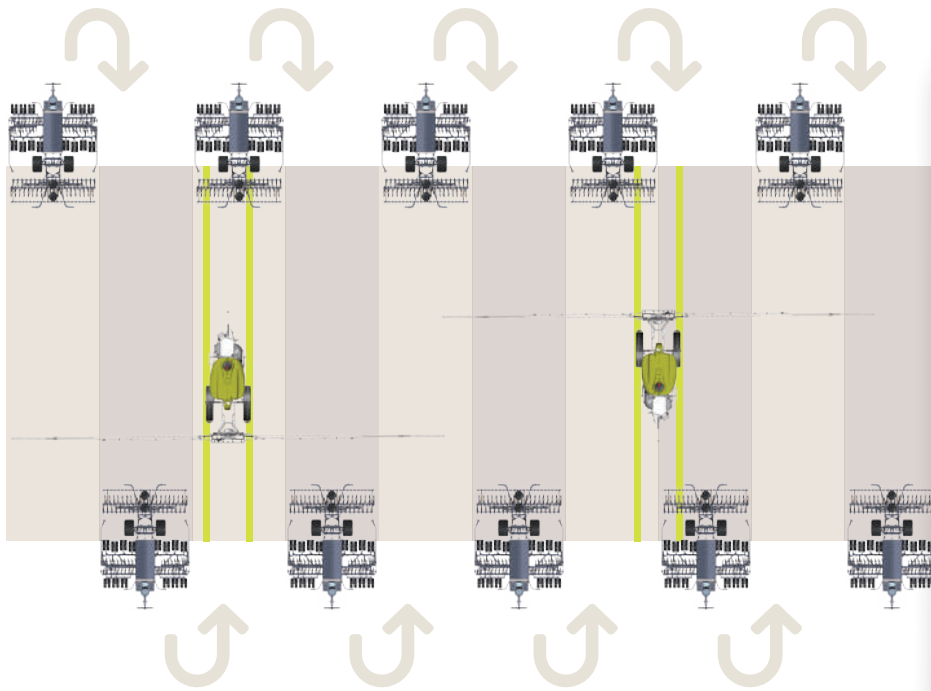

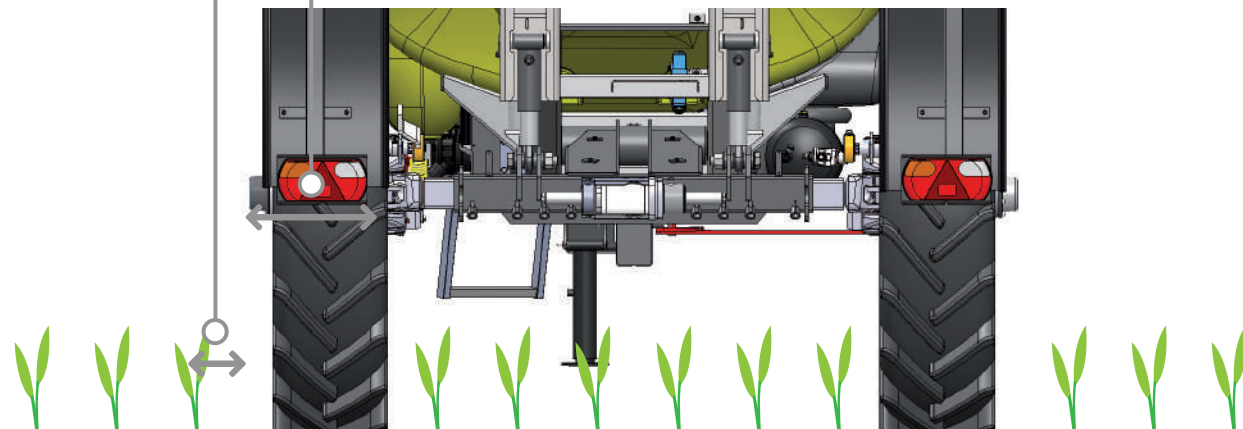
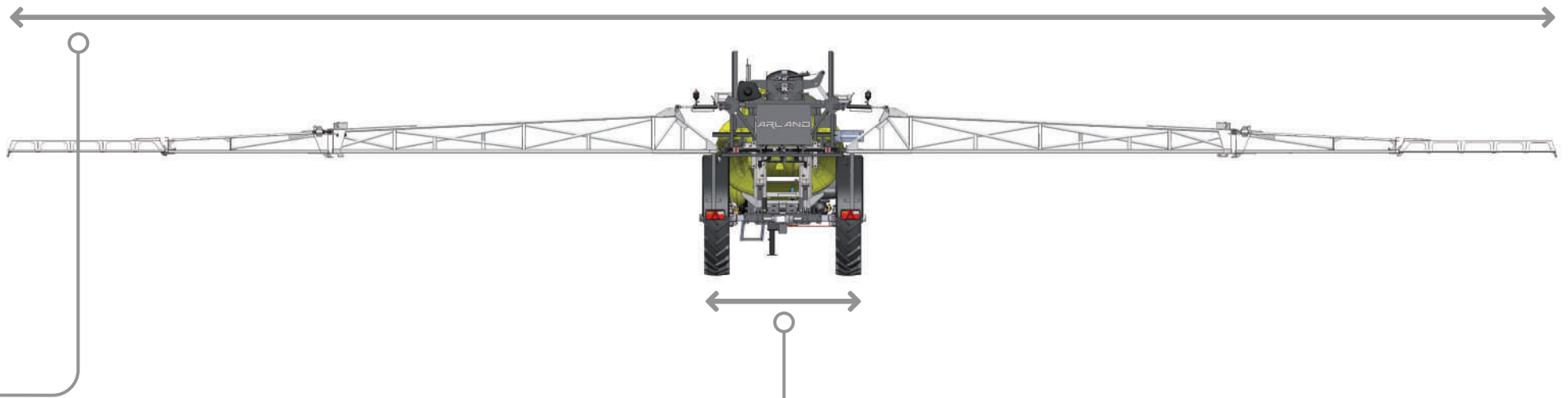

# E-Drive



50 kg



15 kg

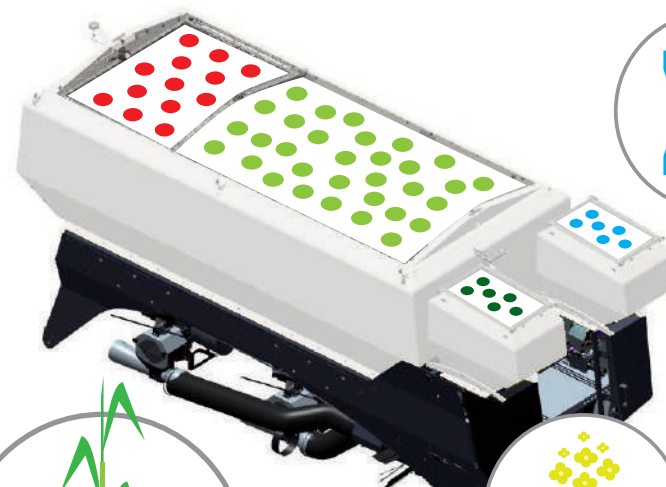

2.3 kg



100 kg



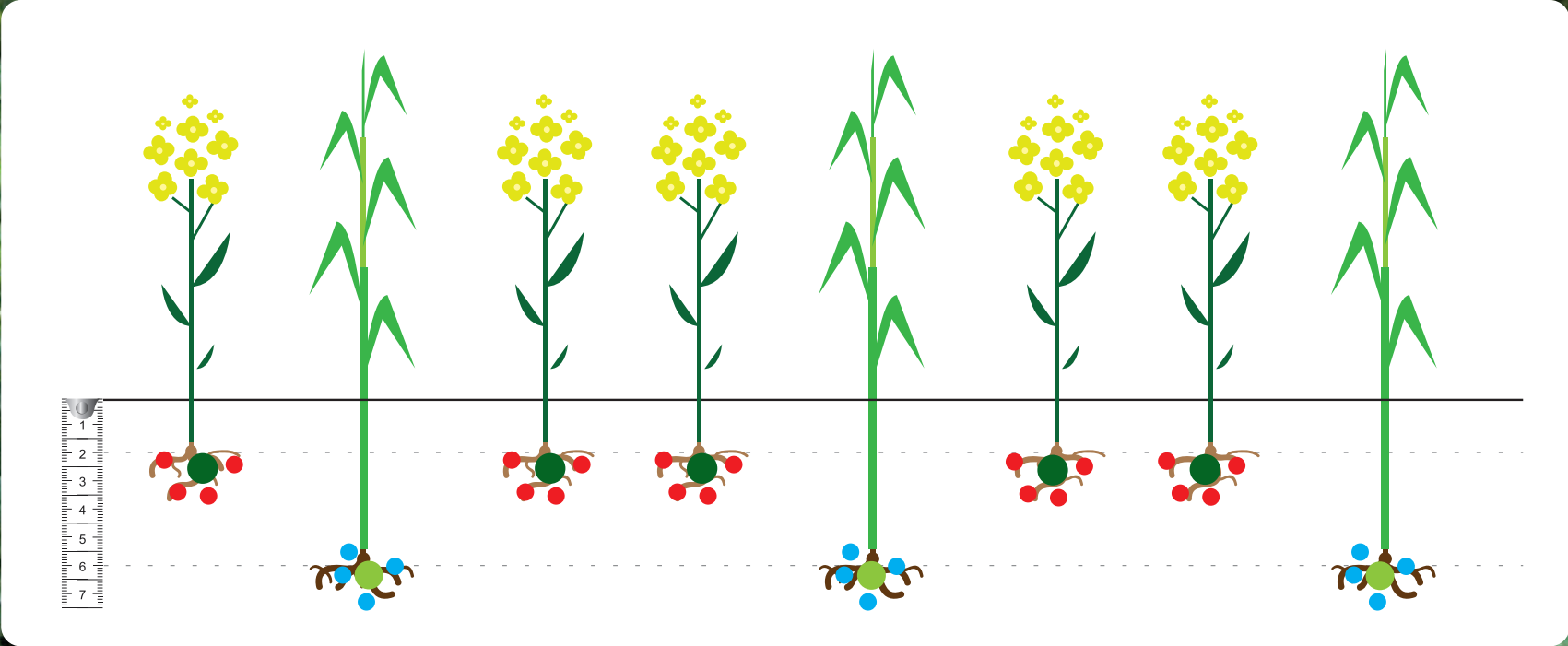
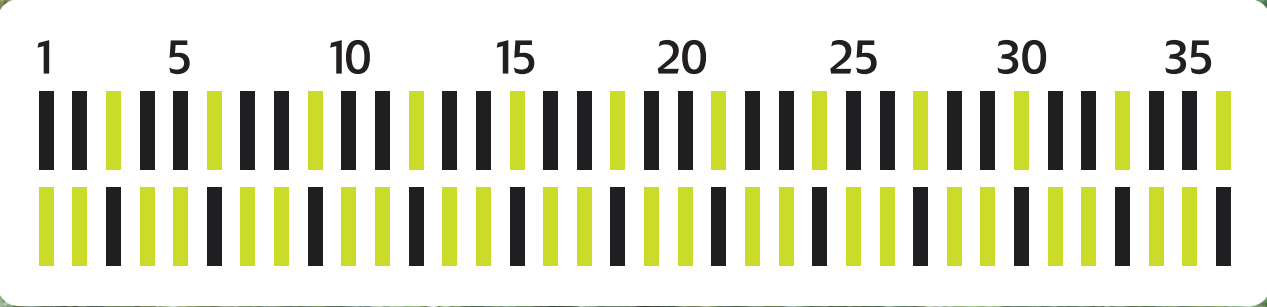

# E-Drive

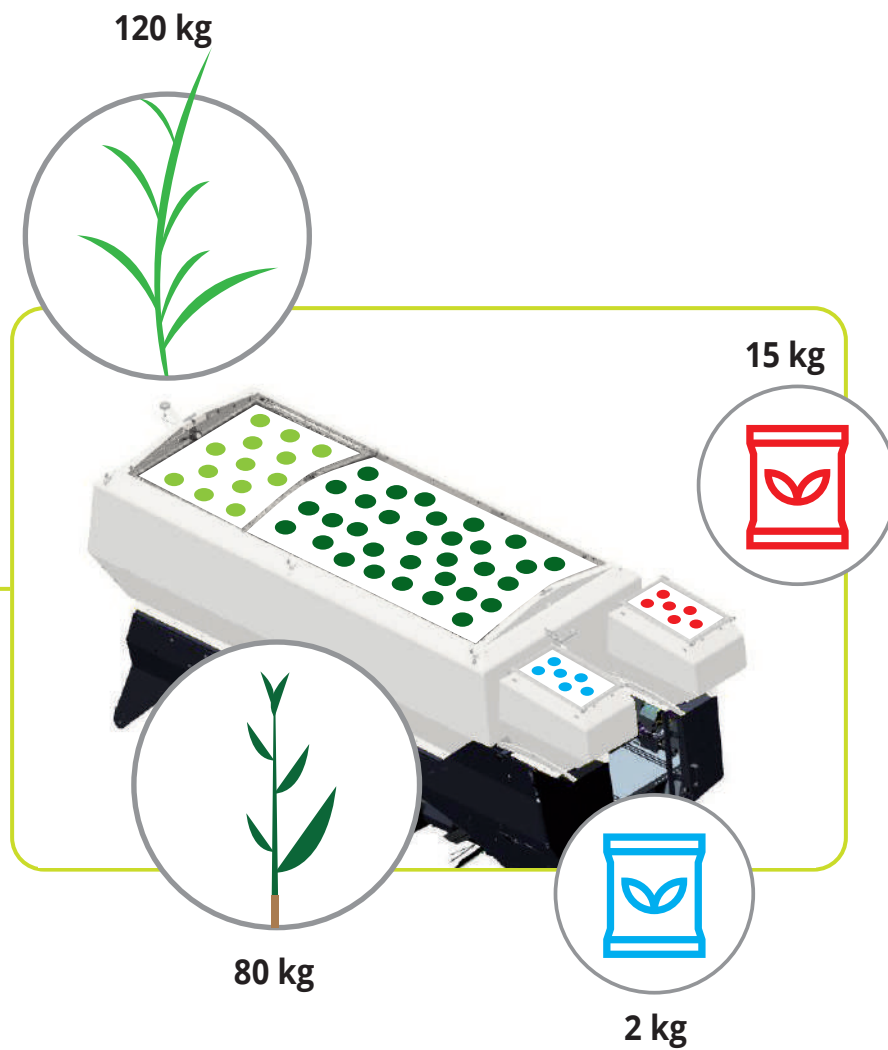

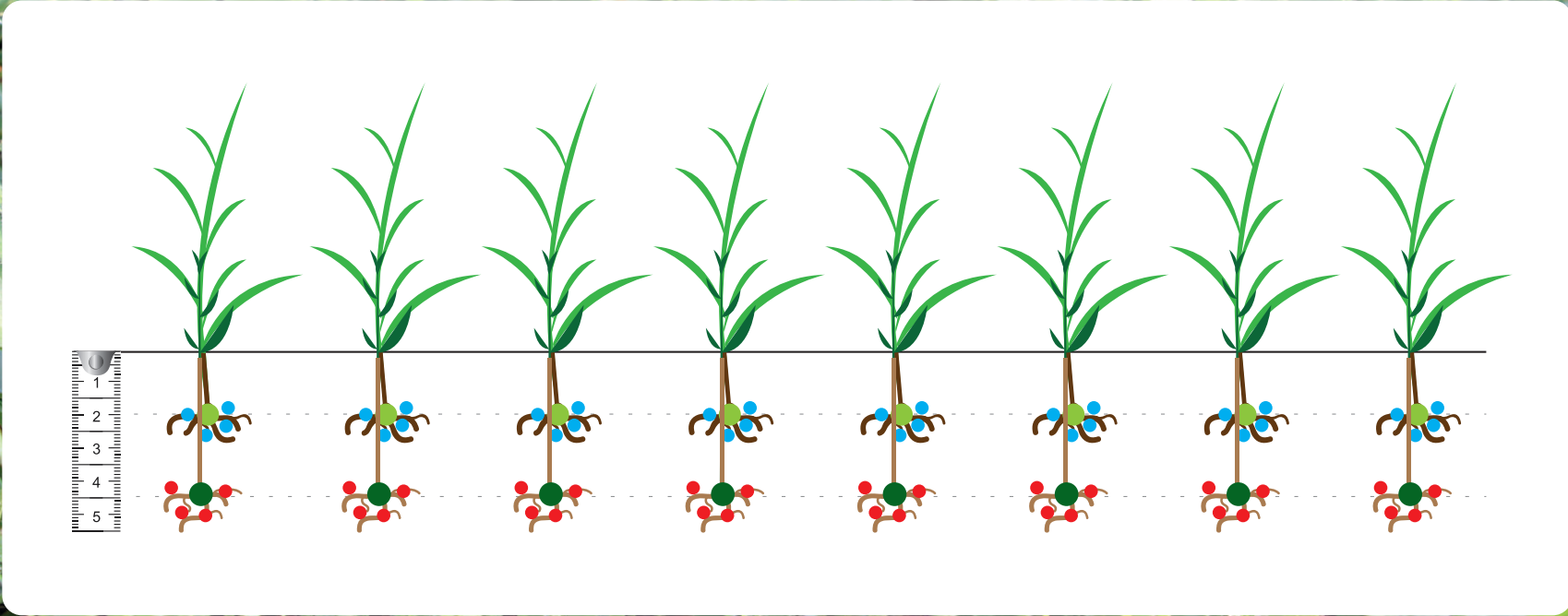
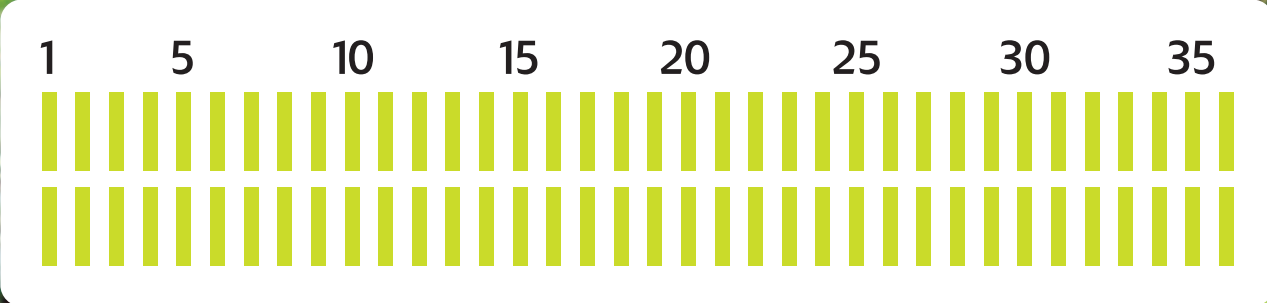

# E-Drive

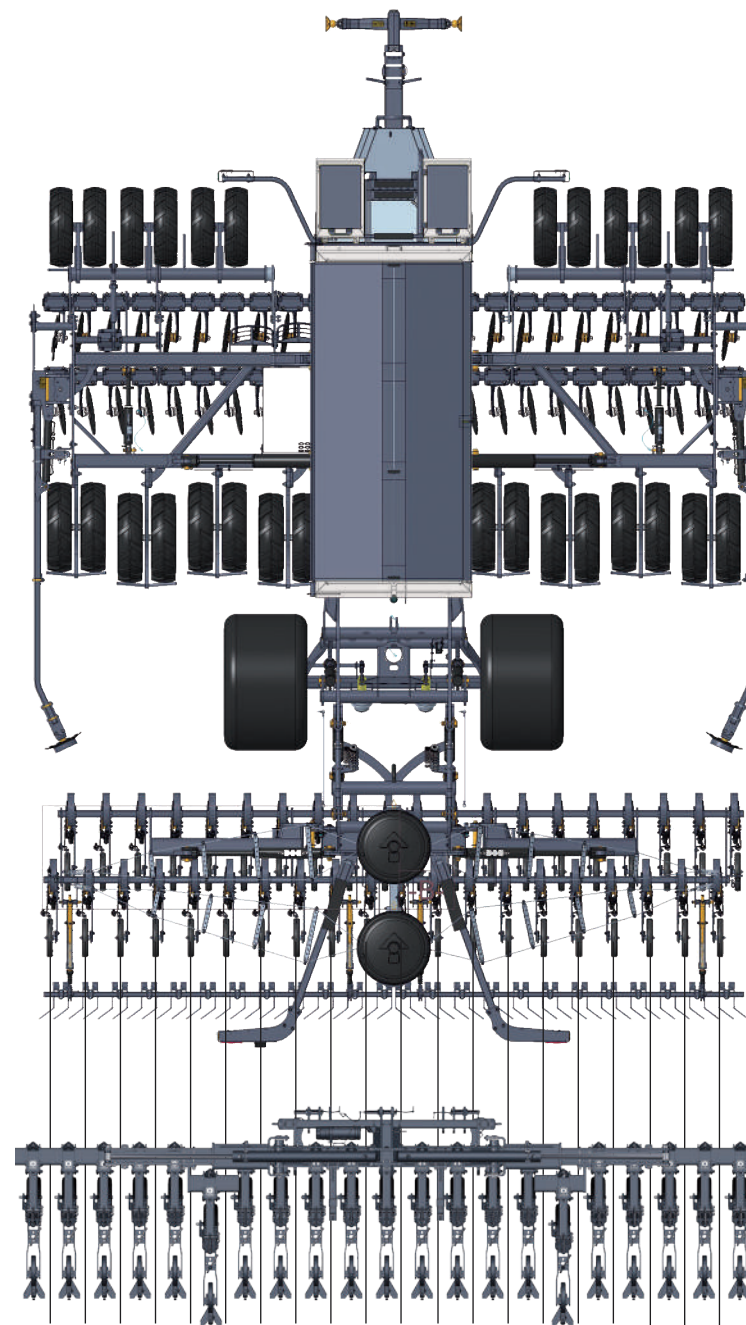



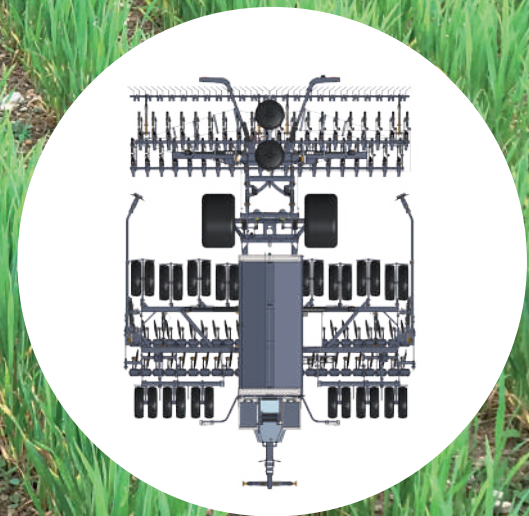
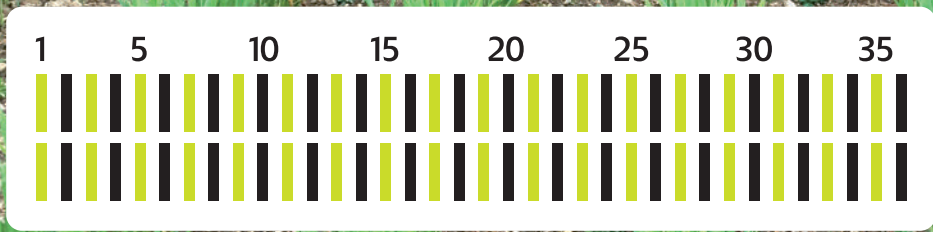
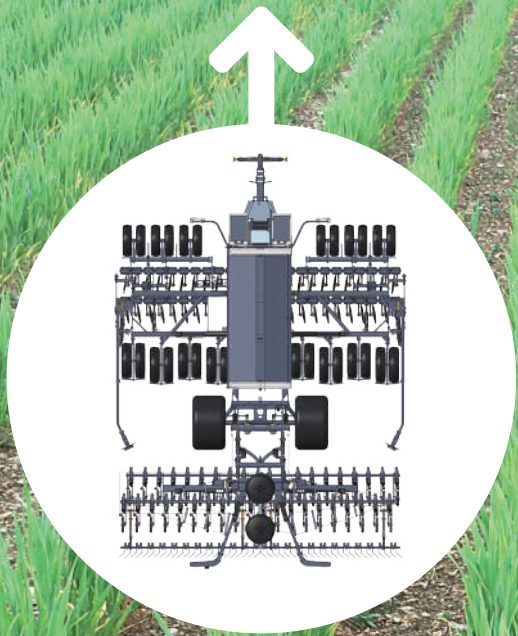



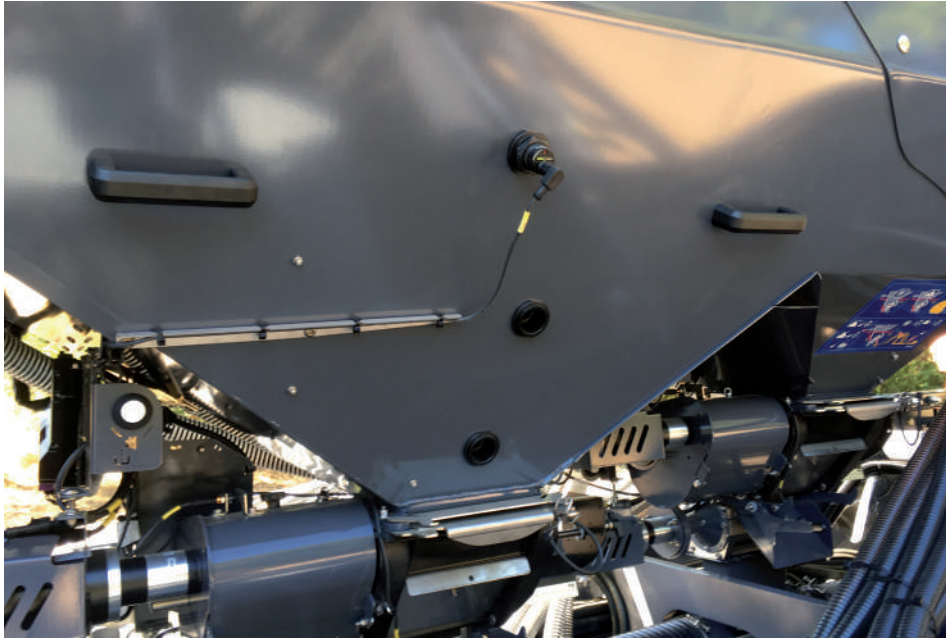









Type	MAXIDRILL P120 3M	MAXIDRILL P120 4M	MAXIDRILL P120 4M W	MAXIDRILL P120 6M W
 (L)		3000		4100
 (L)		1760 + 1240 1440 + 1560 2900 + 100		2450 + 1650 1800 + 2300 4000 + 100
 (m)	3	4	4	6
 (m)	3	4	3	3
 (cm)	248		260	290
 (cm)			108 x 258	
 (x)	20		28	40
	15		14,3	15
 (x)	24		32	48



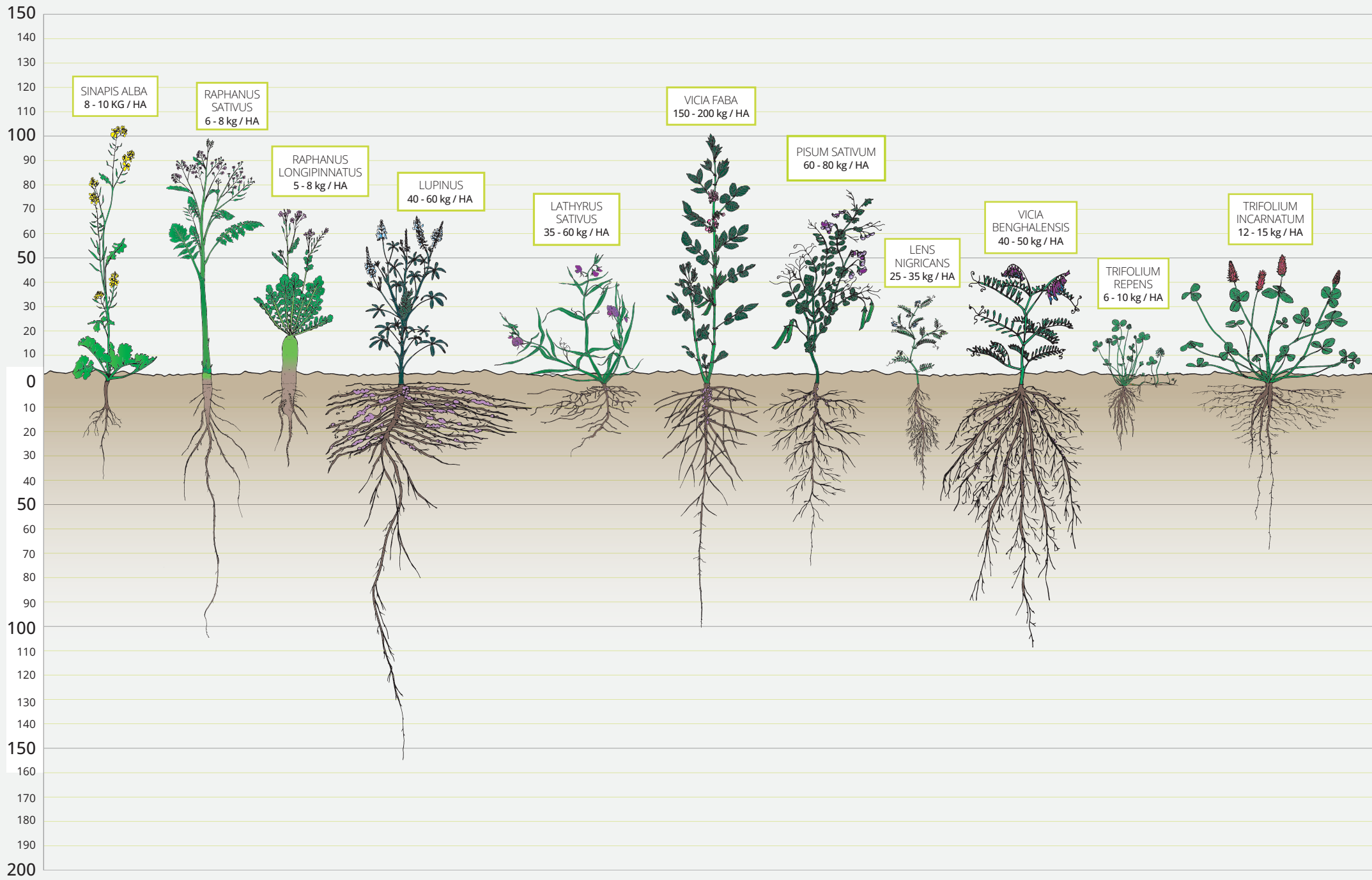

TRIFOLIUM  
ALEXANDRINUM  
10 - 15 kg / HA

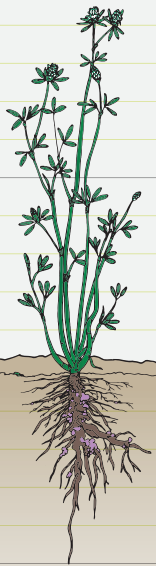

ONOBRYCHIS  
40 - 50 kg / HA



LOTUS  
CORNICULATUS  
10 - 15 kg / HA



LINUM  
USITATISSIMUM  
20 - 30 kg / HA

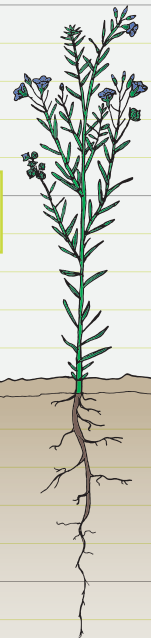

PHACELIA  
TANACETIFOLIA  
6 - 10 kg / HA

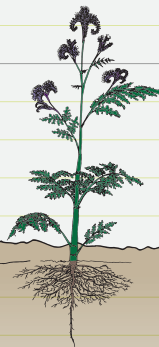

FAGOPYRUM  
ESCULENTUM  
40 - 60 kg / HA

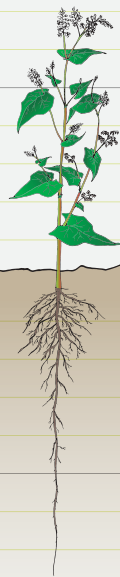

HELIANTHUS  
ANNUUS  
20 - 25 kg / HA

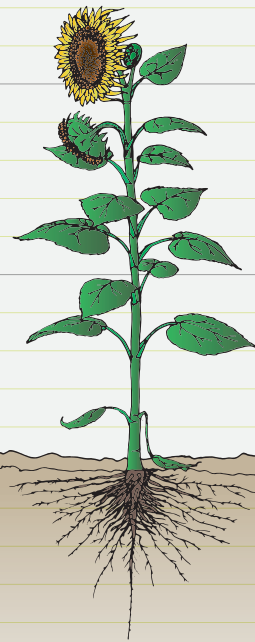

GUIZOTIA  
ABYSSINICA  
8 - 12 kg / HA



AVENA STRIGOSA  
35 - 50kg / HA

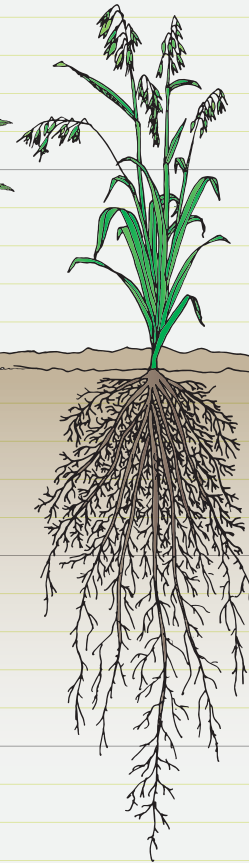

SECALE  
MULTICAULE  
25 - 30 kg / HA

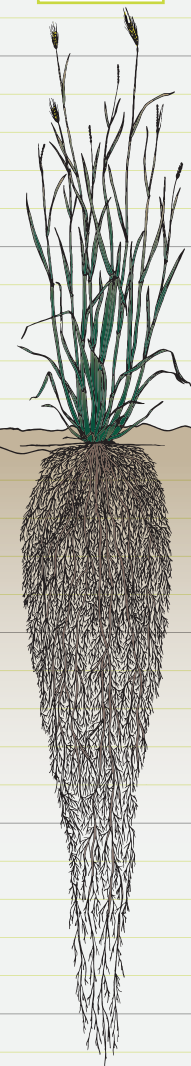

CAMELINA SATIVA  
3 - 5 kg / HA

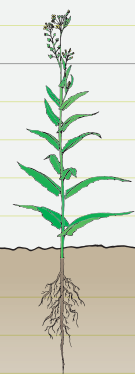

**SKY**  
AGRICULTURE



### Châteaubourg

P.A. de la Gaultière  
35220 Châteaubourg

### Fontenay

21 Rue Jean Monnet  
28630 Fontenay-sur-Eure

### Carvin

Rue du Pont de Grès  
62220 Carvin

### Osasco

Via Garzigliana, 37  
10060 Osasco TO, Italie

### Ferme de la Conillais

Saint-Émilien-de-Blain  
44130 Blain

☎ Tél : +33 (0)2 99 00 84 84

✉ [contact@sky-agriculture.com](mailto:contact@sky-agriculture.com)

🌐 [sky-agriculture.com](http://sky-agriculture.com)