

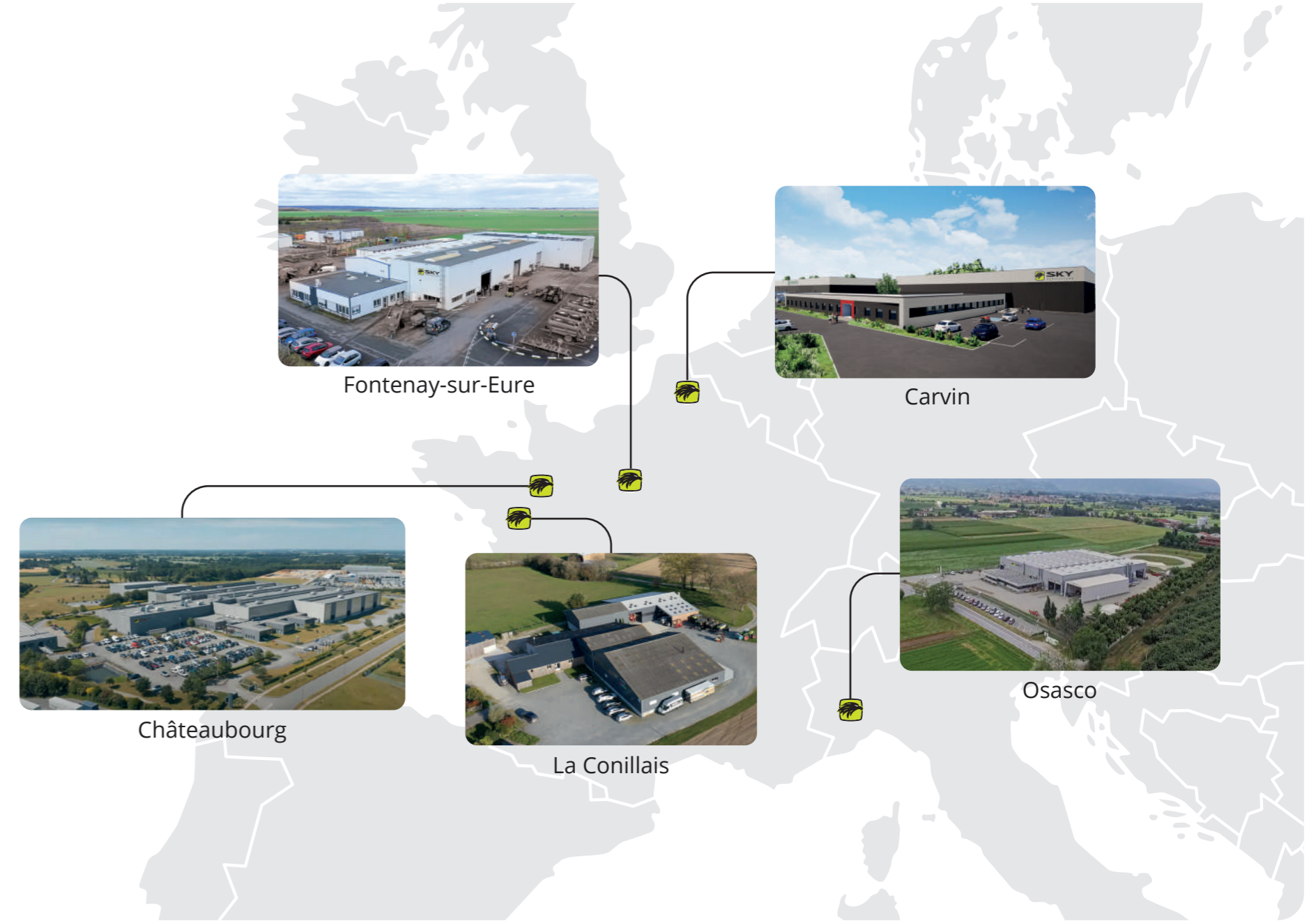

**SKY**  
AGRICULTURE

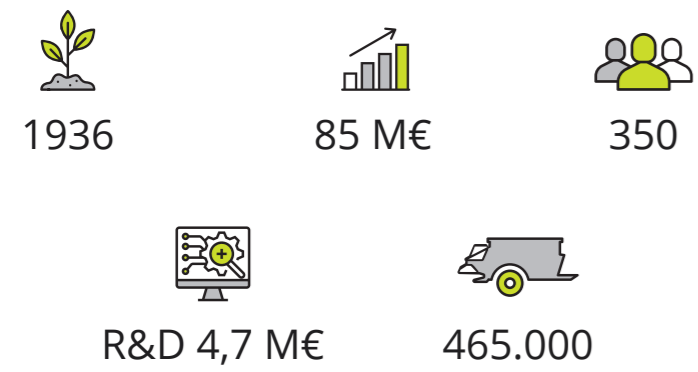

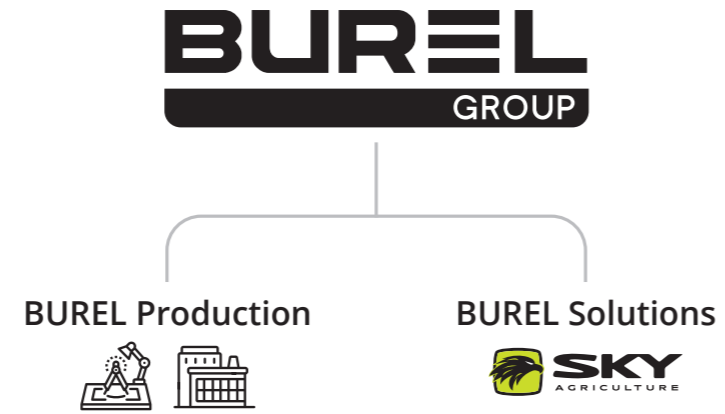

1936 > 2023  
155 000 ex.



1936 - Super Sulky

1936 > 2023  
12 000 ex.



2000 - HR

1936 > 2023  
310 000 ex.



1959 - Sulky Rotor

DEALERS  
460  
CONCESSIONNAIRES



2022



2023



- ✓ Precision
- ✓ Technology
- ✓ Agronomy
- ✓ Energetic efficiency





\*Un concentré de Sulky.



A concentrate of Sulky.\*



\*Ne faire qu'un.

# A NEW VISION FOR THE FARMING WORLD\*

\*Une nouvelle vision pour le monde de l'agriculture



**PRECISION**  
*Précision*



**TECHNOLOGY**  
*Technologie*



**ENERGETIC EFFICIENCY**  
*Efficacité énergétique*

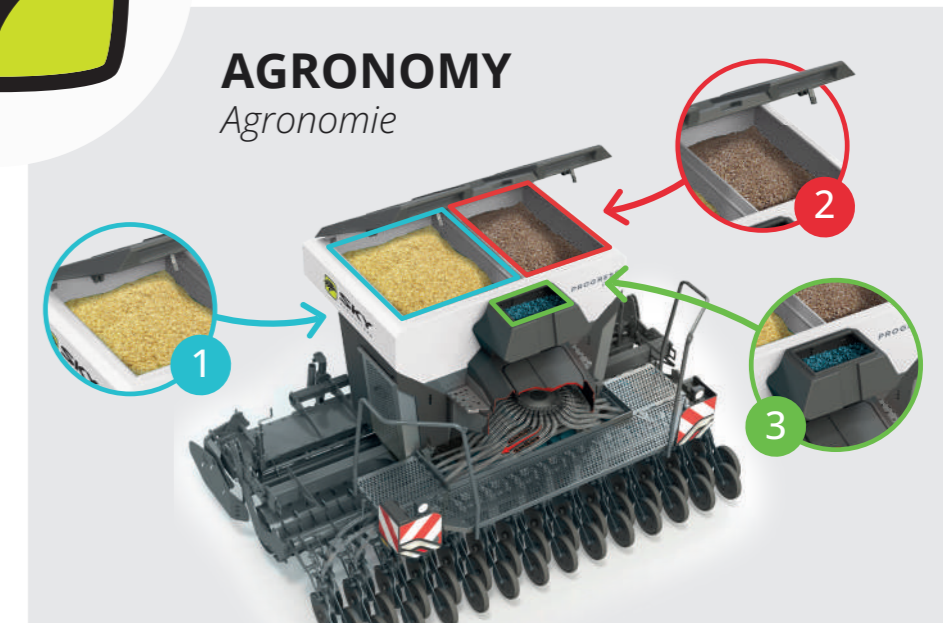

**AGRONOMY**  
*Agronomie*





# Challenges

Enjeux

✓ **CLIMATE**  
Climat

✓ **ENERGY**  
Énergie

✓ **FERTILIZATION**  
Fertilisation

✓ **BIODIVERSITY**  
Biodiversité

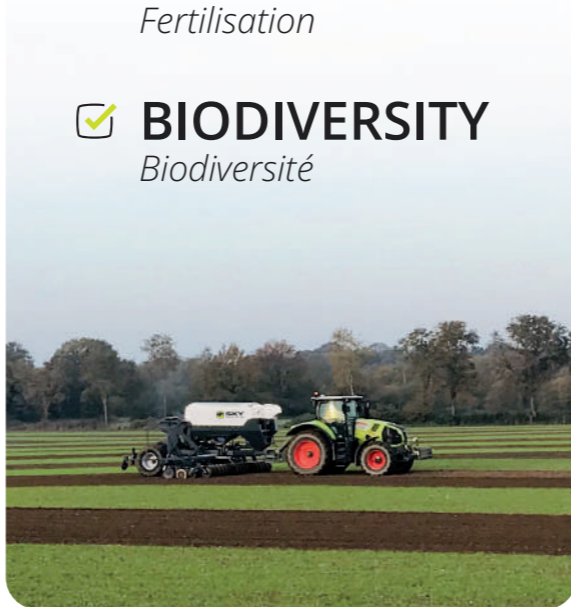

Precision fertilization

Fertilisation de précision



Sowing cover crops and sowing in cover crops

Semer des couverts et dans les couverts

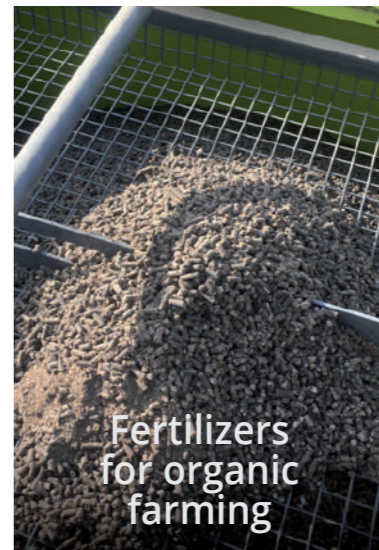

Fertilizers for organic farming

Engrais Organiques pour l'AB



Sowing companion plants

Semer des plantes compagnes

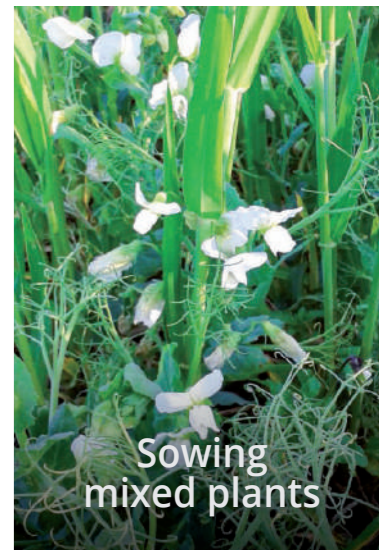

Sowing mixed plants

Semer des mélanges



## OUR 10 AGRONOMIC AND TECHNOLOGICAL SOLUTIONS

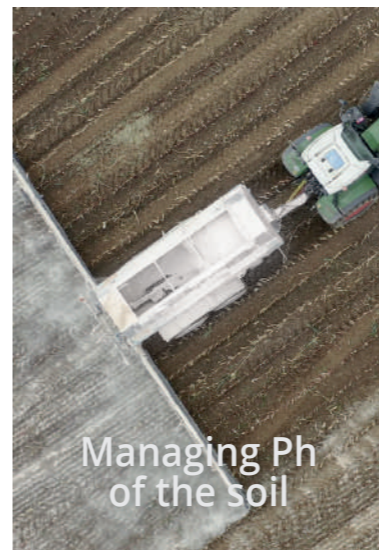

Managing Ph of the soil

Gérer le pH des sols

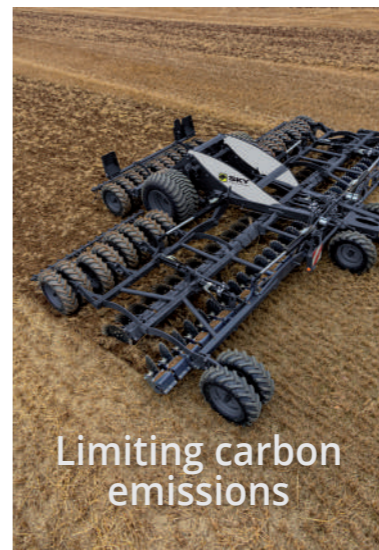

Limiting carbon emissions

Limiter les émissions de Carbone



Mechanically manage weeds before sowing

Gérer mécaniquement les adventices avant le semis



Mechanically manage weeds after sowing

Gérer mécaniquement les adventices après le semis



Fertilize as close as possible to plants

Localiser la fertilisation au semis



# La Conillais

FARM - TRAINING - AGRONOMY



**WE ARE** Knowledge PRIDE **FARMERS**  
functional biodiversity Agronomic and technological





# FARMING TOGETHER

Be positive about Agriculture

*Positiver sur l'agriculture*

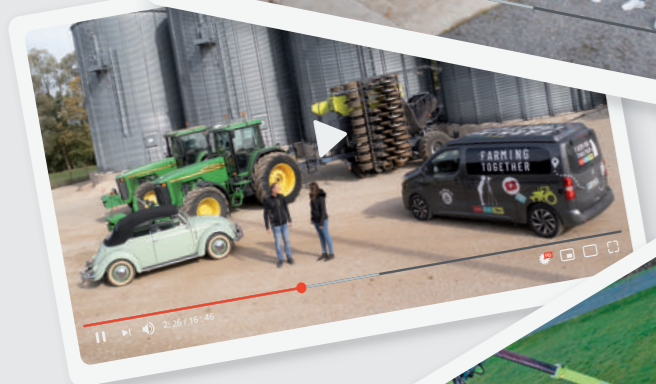

S'ABONNER

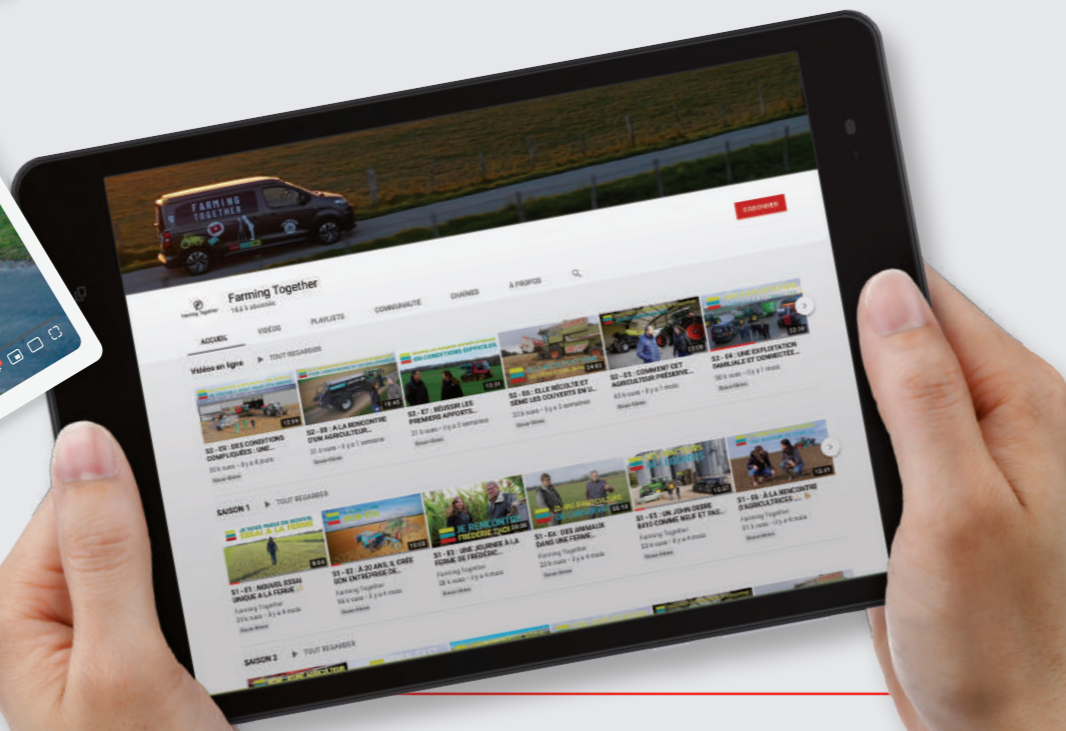

Softshell



Veste matelassée



[www.farming-together.com](http://www.farming-together.com)



# MAKE YOUR SKY EXPERIENCE EASIER

Rendre votre expérience SKY plus facile

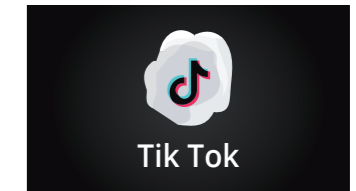
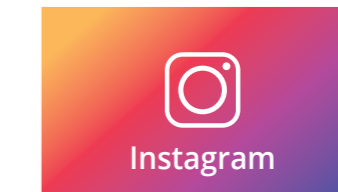
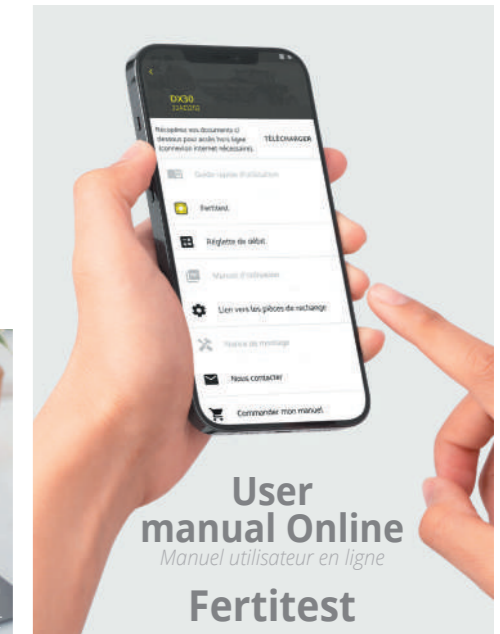
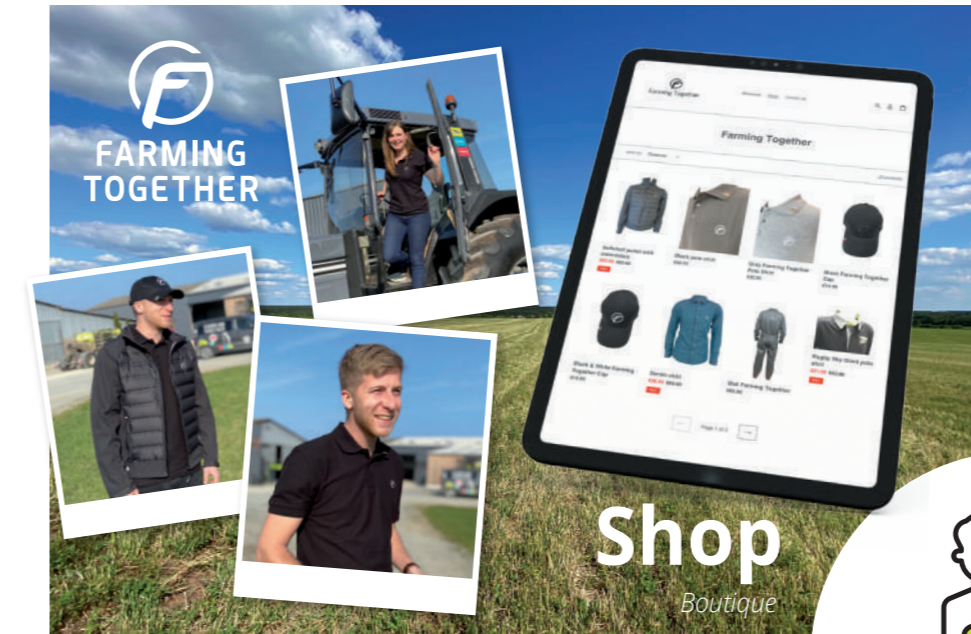

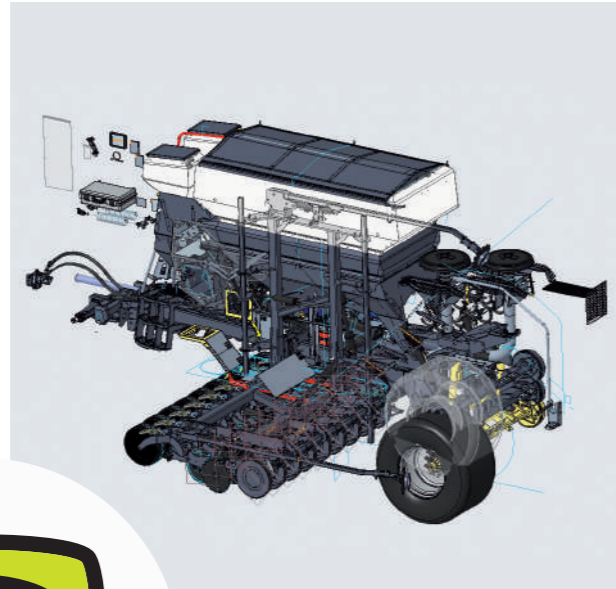

R&D > 4,7M€ / Year

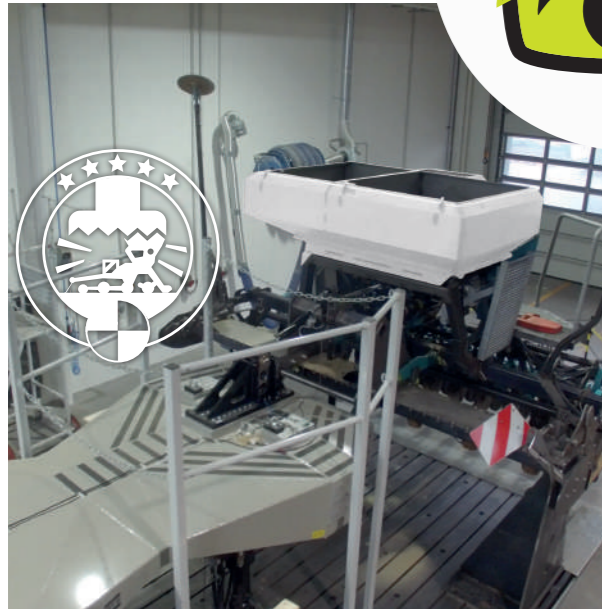



**TECHNICAL TRAINING CENTER**  
*Centre de formation technique*  
600 m<sup>2</sup>



**SPARE PARTS MANAGEMENT STORE**  
*Magasin PDR*  
1050 m<sup>2</sup>



**TILLAGE FACTORY EXTENSION**  
*Extension usine travail du sol*  
1630 m<sup>2</sup>

**2023 INVESTMENTS** *Investissements*

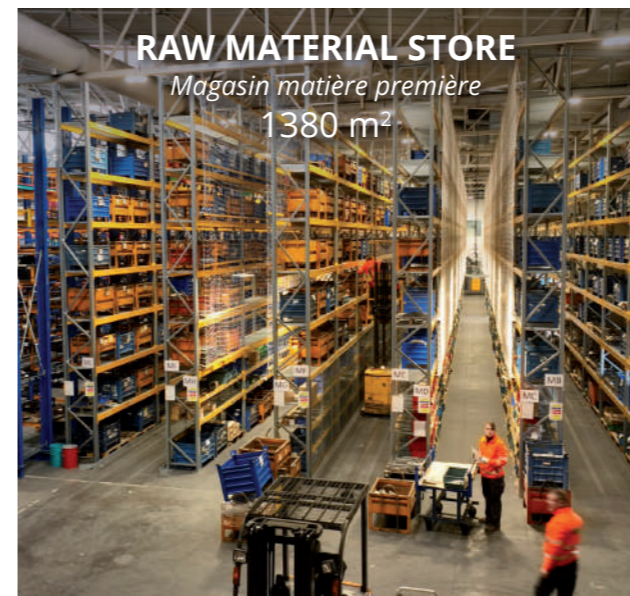
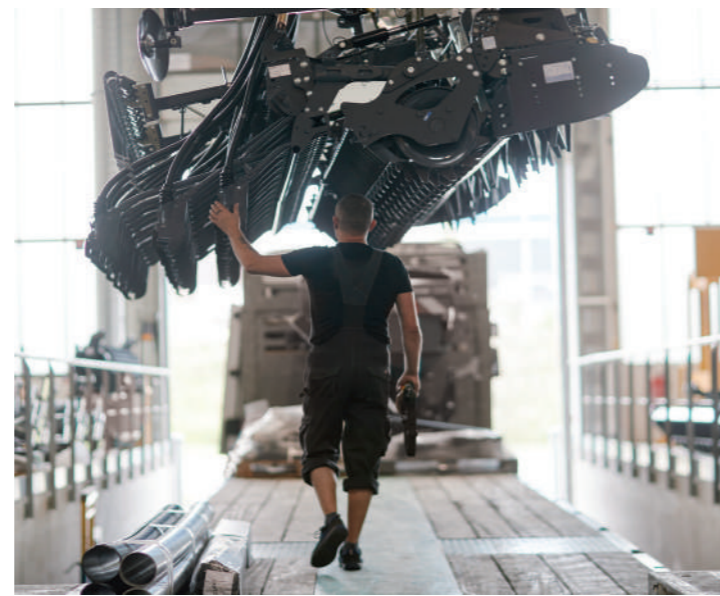
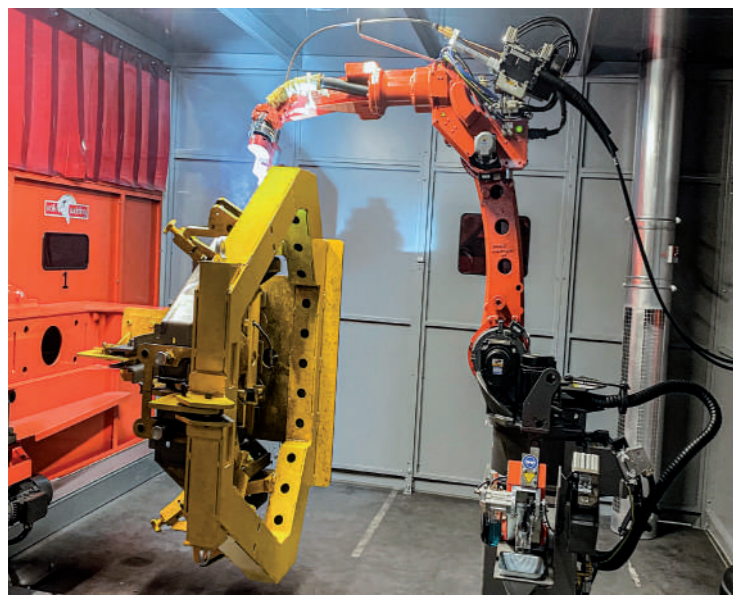

**RAW MATERIAL STORE**  
*Magasin matière première*  
1380 m<sup>2</sup>



**CARVIN SITE RENOVATION**  
*Rénovation site Carvin*  
2800 m<sup>2</sup>

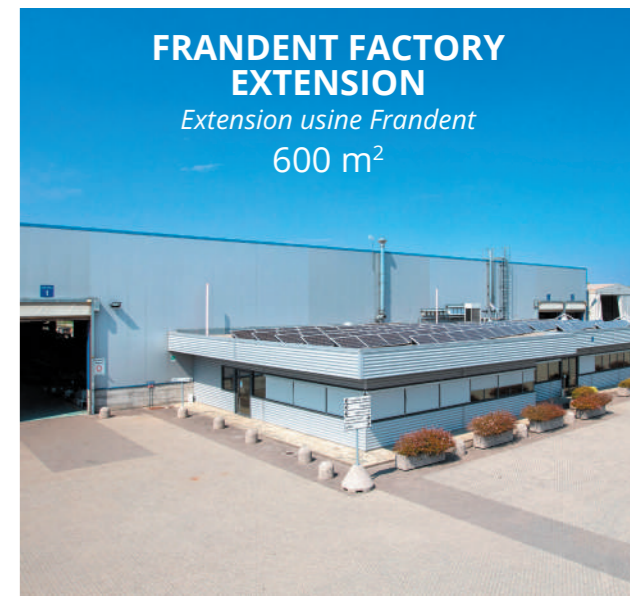

**FRANDENT FACTORY EXTENSION**  
*Extension usine Frandent*  
600 m<sup>2</sup>



**Soil Preparation**  
*Travail du sol*



**Seeding**  
*Semis*



**Fertilization**  
*Fertilisation*

**Soil Preparation** *Travail du sol*



**Seeding** *Semis*



**Seeding** *Semis*



**Fertilization** *Fertilisation*



Range *Gamme*

# Soil Preparation *Travail du sol*

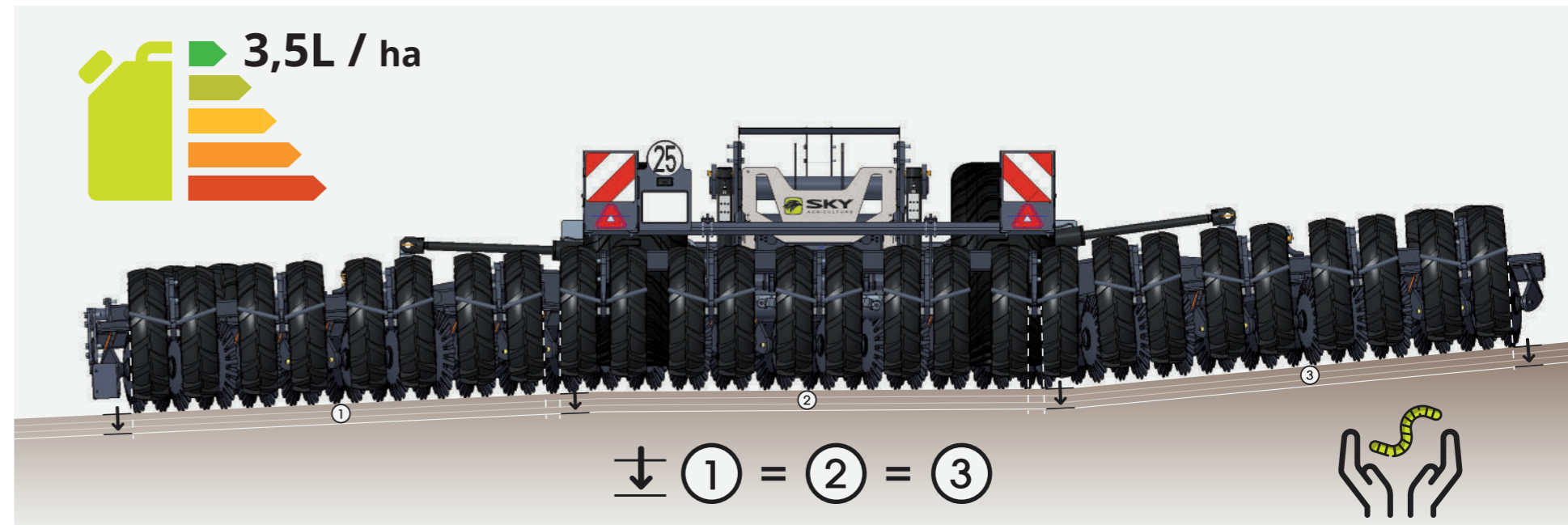
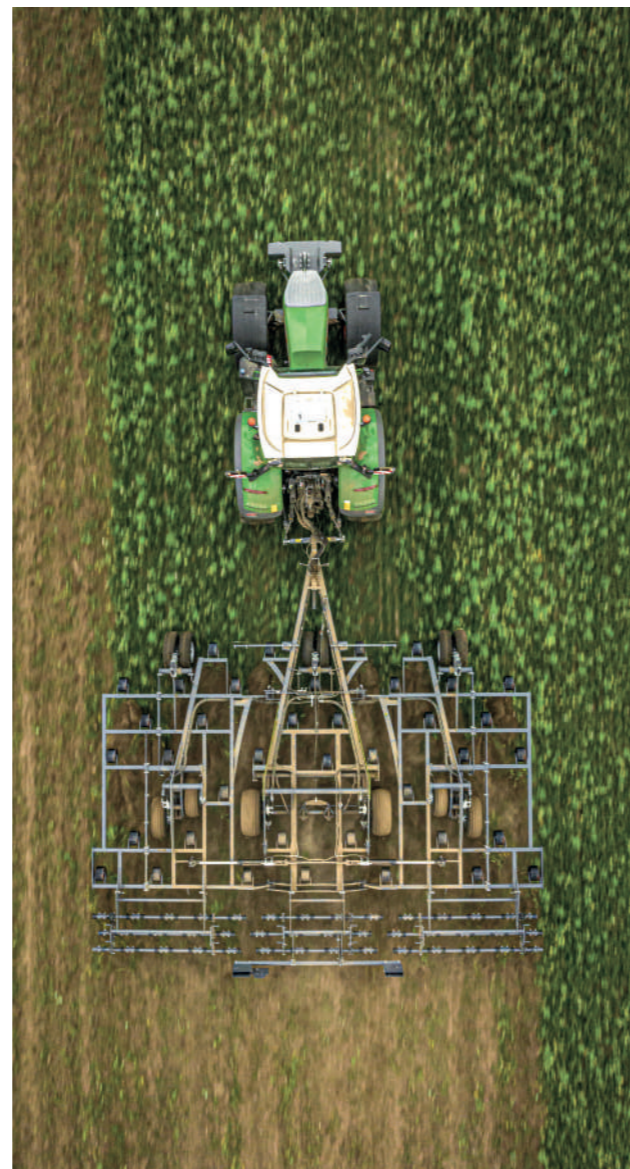

✓ Energetic efficiency *Efficacité énergétique*

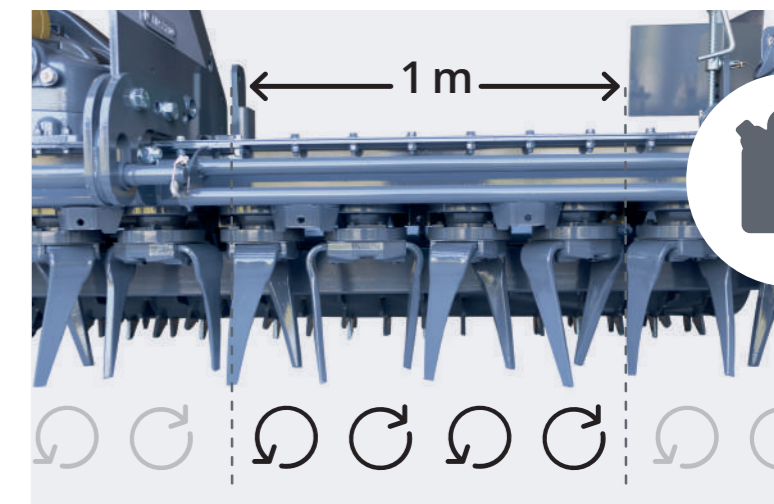

# Seeding *Semis*

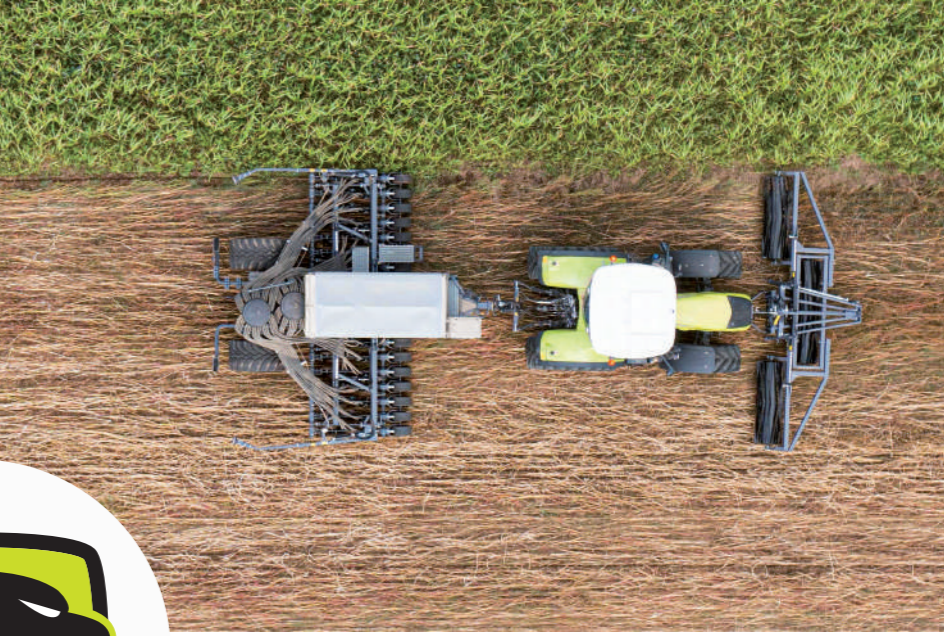



# Fertilization *Fertilisation*

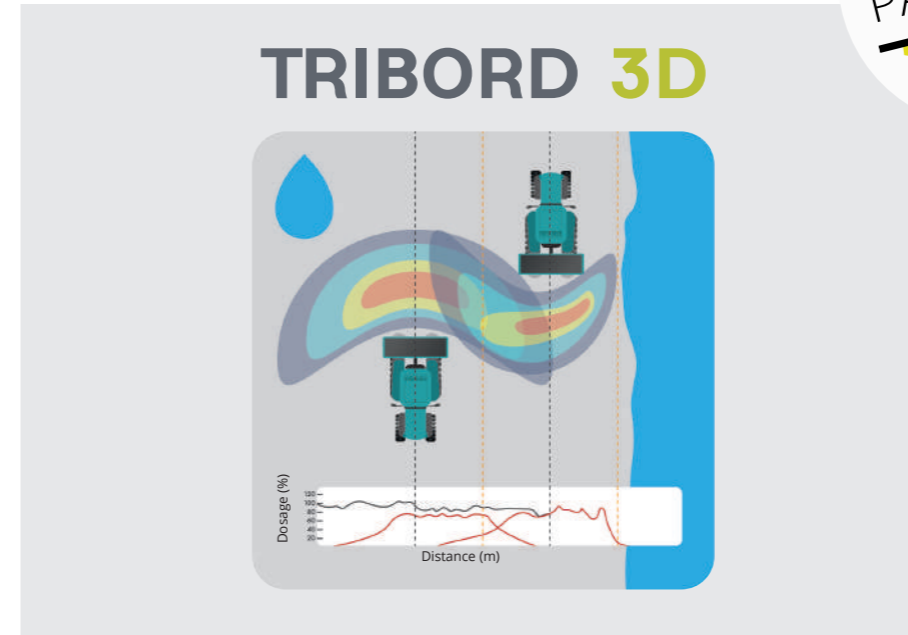



# PARTS *Pièces*



## NEW ORGANIZATION *Nouvelle organisation* 2023/24

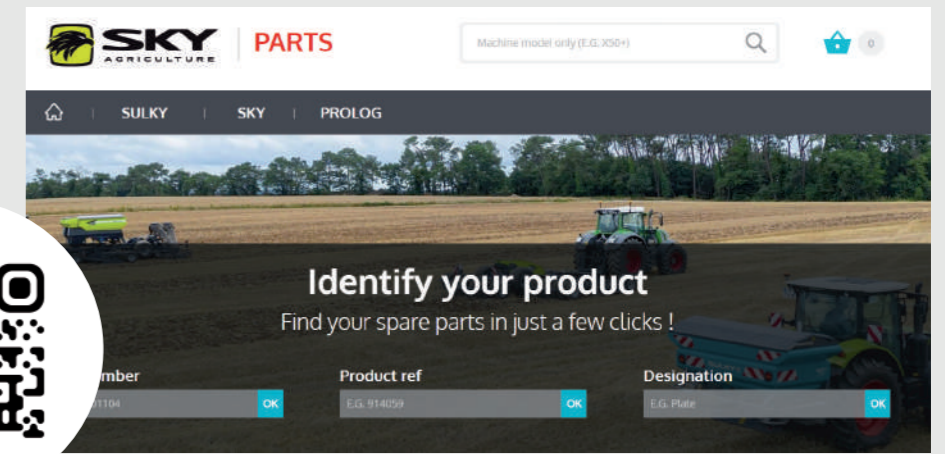

### STANDARD EXCHANGES *Échanges standards*

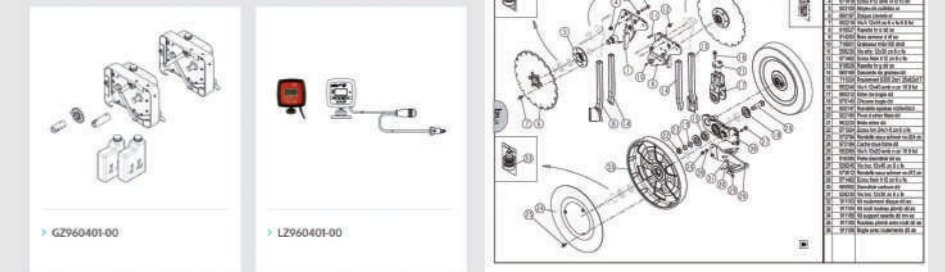







### **Châteaubourg**

P.A. de la Gaultière  
35220 Châteaubourg

### **Fontenay**

21 Rue Jean Monnet  
28630 Fontenay-sur-Eure

### **Carvin**

Rue du Pont de Grès  
62220 Carvin

### **Osasco**

Via Garzigliana, 37  
10060 Osasco TO, Italie

### **Ferme de la Conillais**

Saint-Émilien-de-Blain  
44130 Blain

 Tél : +33 (0)2 99 00 84 84

 [contact@sky-agriculture.com](mailto:contact@sky-agriculture.com)

 [sky-agriculture.com](http://sky-agriculture.com)