

VALOTERRA

The new benchmark in precision planting



MONOSEM FOUNDING PRINCIPLES

Seed planting is an investment and a crucial step in ensuring crops reach their full potential. Many farmers in over **80 countries** worldwide have chosen to rely on **Monosem** technology. **We can now boast over 70 years of shared history.**

Today, this relationship built on reliability, durability and agronomic performance has been strengthened by technological innovations. From planters to cultivators, intelligence is at the heart of all **Monosem** equipment.

Our goals rest on three pillars: innovation for agriculture, top-quality performance and intelligence-driven sustainability.

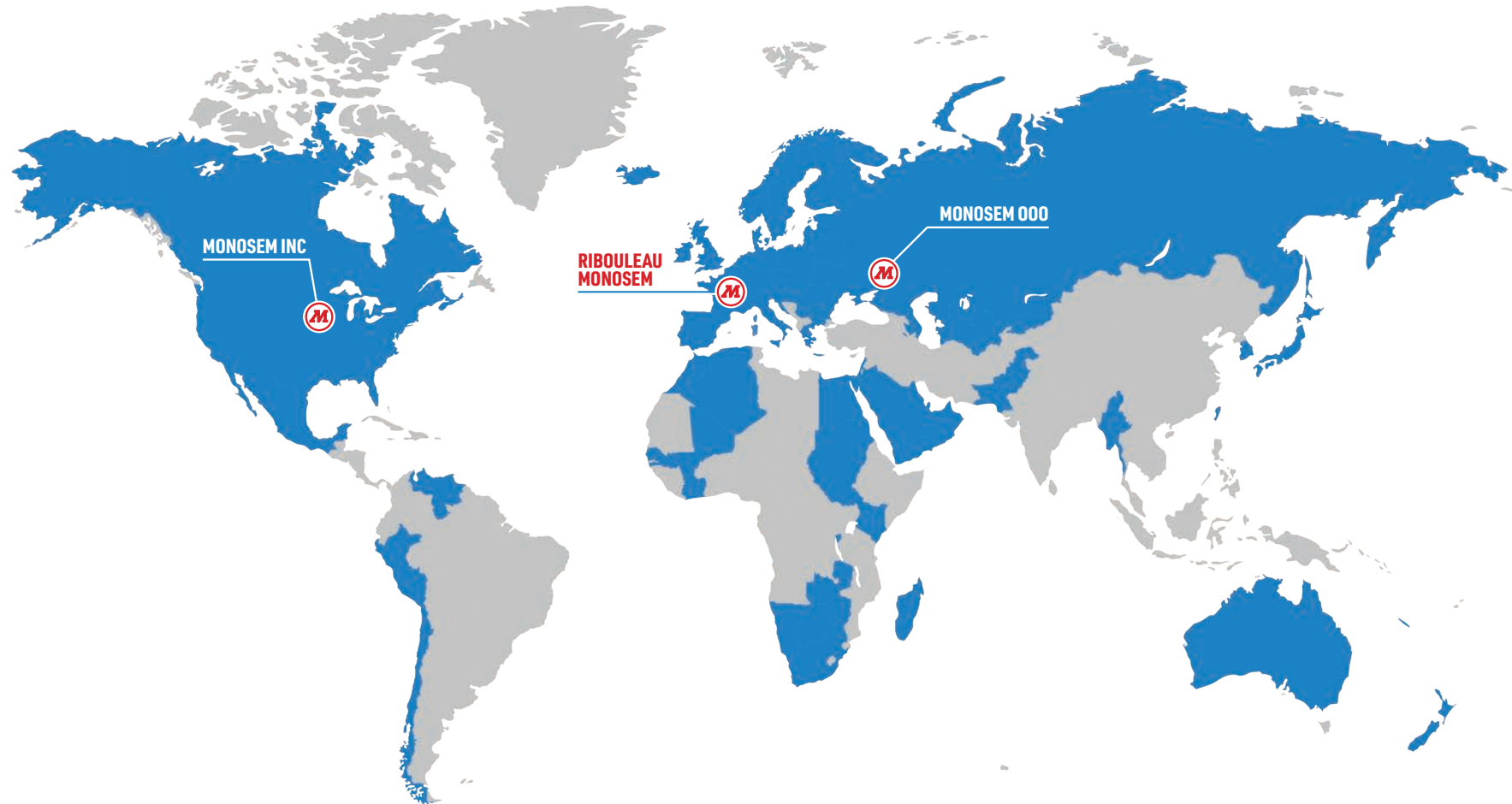

ValoTerra

THREE-DIMENSIONAL ELECTRO-PERFORMANCE

ValoTerra is the new generation of precision planter from **Monosem**.
ValoTerra ensures your land is used to its full potential, while also protecting it.



Given that the best yields depend on emergence quality, the new **ValoTerra** planter has been designed with that in mind. Emergence quality combined with time-saving operating efficiency goes hand-in-hand with profitability and excellent ROI. This is explained in the **ELECTRO PERFORMANCE 1 (eP1)** section.



You can only reap the benefits of your soil if you protect it!
All the technological prowess of our group is brought together in the **ValoTerra**. Enjoy discovering the intelligence behind our environmentally responsible solutions in the **ELECTRO PERFORMANCE 2 (eP2)** section.



The **ValoTerra** is designed to optimise the profitability of your operations (**eP1**), with environmental protection in mind (**eP2**).
But why stop there? We go a step further by offering you exceptional ease of use and operating pleasure.
The **ValoTerra** is a perfect example of down-to-earth technology open to new horizons. Discover our wide range of solutions in the **ELECTRO PERFORMANCE 3 (eP3)** section.

ValoTerra

— ULTIMATE —



**Welcome to the fourth dimension with the ValoTerra
Ultimate!**

With its new **ASG** (active seed guidance system), the **ValoTerra Ultimate** can reach unprecedented working speeds without compromising planting quality.

Details of this Monosem innovation can be found in the **ELECTRO-PERFORMANCE 4 (eP4)** section.



EMERGENCE AND PRODUCTIVITY DRIVING PROFITABILITY

The **ValoTerra** planter's new 100% electric architecture, unique seed metering box and planting accuracy and uniformity guarantees improved emergence and productivity.



cept



Emergence and Productivity driving profitability 

Smart solutions promoting sustainability 

Technology enhancing ease of use and operating pleasure 

ValoTerra Ultimate optimal emergence at all speeds 

ACCURACY FROM START TO FINISH

- 01 56V architecture
- 02 ValoTerra seed metering
- 03 Metering unit
- 04 Planting



A NEW 56V ARCHITECTURE

We opted for a **56V** system to unleash the performance potential of the **ValoTerra** planter.

The **56V architecture** means you can add more motors thanks to a generator capable of supplying almost **5.6kW** of power.

This capacity is a gateway towards **ultra-precision agriculture**.

The new 56V system paves the way for smart planting.

It optimises seed density and the dosing of other inputs, along with their distribution, based on the characteristics of your fields.



VALOTERRA SEED METERING

The seed metering box is the planter's core component.

We have ensured it is precise and versatile, to meet the agronomic performance and crop diversification needs of the future.

The **ValoTerra's** metering box introduces a new benchmark for precision planters.

Beyond offering improved performance, it has been specifically designed to be easy to use, versatile and robust.

Its electric motor and ergonomic design offer a great combination of leak-tightness and vacuum, providing utmost precision at high speed.

EASY TO USE

- + Changing the seed discs is a breeze when you need to switch from one seed variety to another
- + Changing crops takes less than a minute per row
- + Seed flow can be cut off to give access to the metering box even when the hopper is full
- + Easy to empty

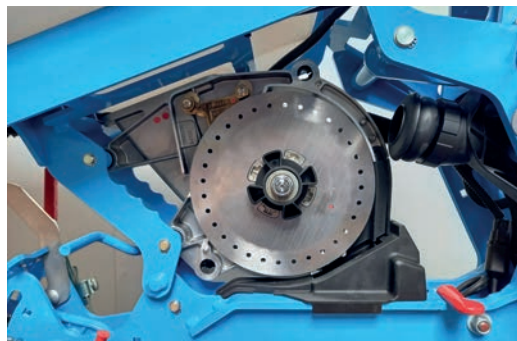

VERSATILE

- + Pneumatic metering and smooth discs ensure perfect distribution for a maximum range of seeds and crops
- + Optimised suction for wider working ranges
- + Patented system for reducing the torque required to drive the disc independently of the vacuum level

SEED METERING UNIT

Several years of research and exchanges with farming professionals have enabled us to design a seed metering unit that is unbelievably well thought out.

From the metering box to machine maintenance, calibration and settings, everything has been optimised with the unique goal of saving you time.

Now, with the **ValoTerra** planter, you save time in and off the field.

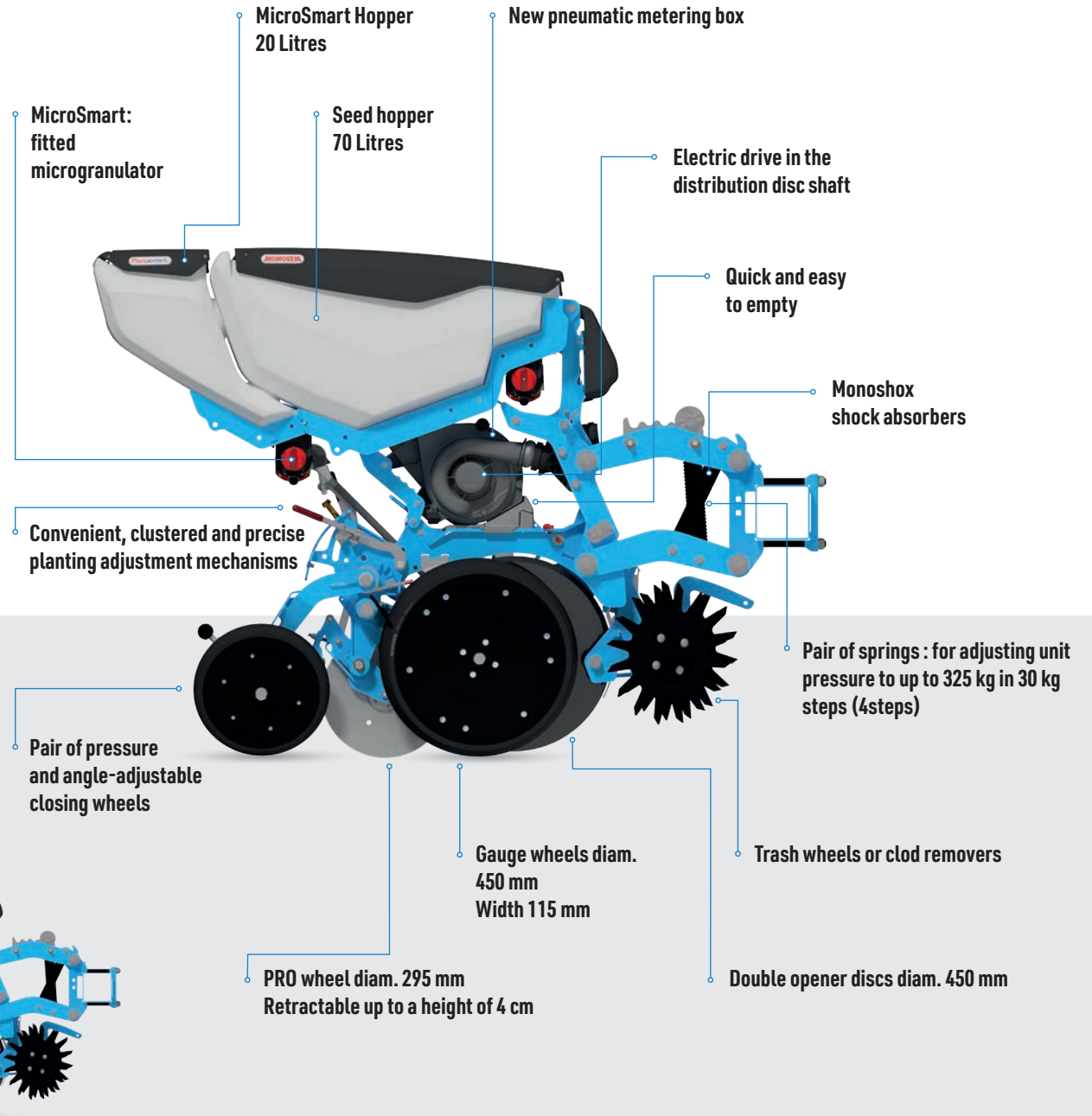

Smart Acces : A unique lifting hopper system!

Routine planter maintenance and servicing are essential for keeping the planter in perfect working order and guaranteeing its durability.

Our team of specialists have therefore developed a patented lifting hopper system for easy maintenance at a convenient height.

Adjustments are now easier to make and maintenance can be carried out safely and efficiently.



PLANTING

With the **ValoTerra** metering unit, we have set a new benchmark in accurate and uniform planting.

We have taken the key features contributing to the success of **Monoshox** metering units and improved them!

From increased penetration force and stability in all situations, to precision settings that closely match agronomic requirements, no effort is spared in unlocking the potential of your crops.



Scan here to see the **ValoTerra** planter in action!

UNFAILING STABILITY

- + Up to 325 kg of pressure on the double opener discs, with suspension ensuring a constant planting depth
- + Efficient penetration with no mud spatter thanks to the largest furrow opener discs (diam. 450 mm) on the market
- + Reduced angle of attack to minimise seed bed disturbance
- + Gauge wheels with a diameter of 450 mm ensure excellent metering unit stability



PRECISE PLACEMENT OF EACH SEED

- + 19 available depth settings
- + V-shaped furrow for accurate seed positioning
- + Individually adjustable suspended Pro wheel, with high-clearance retraction (4 cm)
- + Closing wheel unit with a wide range of wheel pressure and angle settings

QUICK AND EASY TOOL-FREE ADJUSTMENTS

- + Clustered controls to adjust planter settings in next to no time
- + A novel system for adjusting trash wheel height
- + A handy lever to remove the tip located between the double opener discs easily

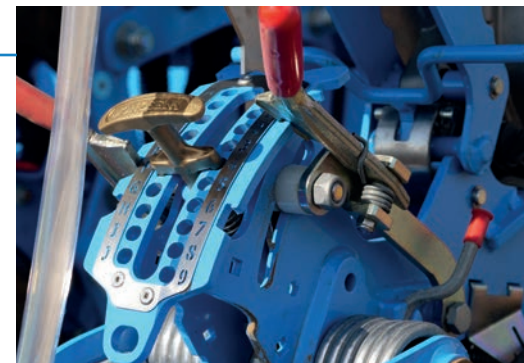



SMART SOLUTIONS PROMOTING SUSTAINABILITY

With **MicroSmart** and **FertiSmart**, **Monosem** is breaking new ground in seed protection and nutrition.

These new solutions combined with our existing **Isobus** features offer unrivalled accuracy and environmental protection.





Emergence and Productivity driving profitability



Smart solutions promoting sustainability



Technology enhancing ease of use and operating pleasure



ValoTerra Ultimate optimal emergence at all speeds



LOOK AFTER YOUR CROPS WITH MONOSEM'S SMART SOLUTIONS

01

MicroSmart

02

FertiSmart

03

TC-GEO

04

TC-SC

MicroSmart

AN INNOVATIVE MONOSEM SOLUTION TO HELP SEEDS THRIVE

This equipment enables you to control your inputs **row by row**.

The new **MicroSmart** microgranulator comes with the **SectionControl** feature as standard, to prevent any overlaps when applying inputs.

All you need is an **Isobus** terminal with this feature enabled to enjoy utmost accuracy and convenience.

Enjoy up to **7% savings on inputs**, which represents an average potential saving of €4.4 per hectare, depending on the product.

What's more, the **MicroSmart** is simply yet ingeniously designed:

- + **MicroSmart** capacity: 20 Litres
- + Easy to calibrate with flexible pipes
- + Ergonomic ON/OFF/EMPTY control dial
- + Colour-coded distribution screw, visible to the user
- + Quarter-turn opening mechanism for changing screws or quick maintenance
- + Convenient loading height for operator comfort and safety



Scan here to see
the **MicroSmart**
microgranulator
in action!





SAFE AND EASY TO USE

- Two tool-free interchangeable screws, for insecticide, molluscicide and microgranular fertiliser inputs
- Gravity-based product metering and delivery to ensure safe operating conditions for users
- Input levels in hoppers are safely monitored by an algorithm



ACCURATE AND LINEAR DOSING

- A linear product distribution range of between 2 to 35 kg per hectare for standard working speeds, products and inter-rows.
- Metering of all products that protect your seeds and young plants from pests
- Metering of microgranular fertilisers to boost seedling growth

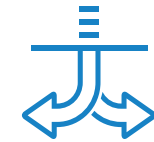

TWO OUTLETS FOR OPTIMUM EFFICIENCY

With a rear-mounted **MicroSmart** unit, you have a choice of two application outlets:

- An outlet for insecticides and microgranular fertilisers, which are buried along with the seeds. It ensures your seeds are well protected and nourished.
- An outlet for applying products to the surface of the furrow, which is ideal for controlling slugs

FertiSmart

A GROUND-BREAKING SOLUTION FOR FERTILISER APPLICATION

FertiSmart is a smart solution for fertilisers, which goes above and beyond the limits of current technologies.

The new **FertiSmart** fertiliser dosing unit, exclusively designed by **Monosem**, is able to apply dry fertiliser, with **row-by-row** section control.

Its revolutionary design guarantees accurate application and a high gravity-based drop rate of up to **600 kg per hectare**.

The **FertiSmart** unit provides optimum performance whatever the terrain, slopes included, even where demanding fertilisers are concerned.



Scan here
to see the
FertiSmart
unit in action!





SAVINGS ON INPUTS

- Reduce costs by 21% thanks to localised application
- Up to 7% savings with row-by-row control
- Cut nutrient loss thanks to in-furrow and point-by-point application
- Less tractor runs required thanks to combined fertiliser and seed protection application



ENVIRONMENTAL BENEFITS

- Accuracy reduces fertiliser volatilisation, leading to an 80% cut in greenhouse gas emissions.

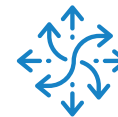

INCREASED VERSATILITY

- Takes slopes in its stride so that even challenging conditions are not a bother
- Meets the very diverse nutritional needs of crops such as rapeseed
- Compatible with various fertilisers (bulk, urea, DAP, etc.)



CONVENIENT AND EASY TO USE

- Easy to maintain, calibrate, empty and service thanks to simple adjustment mechanisms

MONOSEM TC-GEO



THE RIGHT RATE IN THE RIGHT PLACE!

High-precision is the watchword here, to boost savings on inputs, optimise yields and protect the environment!

There was a time when dosing rates adjusted according to a prescription map had to be applied across the entire width of a machine – the planter in our case.

Now, **ValoTerra** has gone a step further to offer you increased precision.

You can now divide the working width into sections of **up to four planter units** to adjust your planting operations to perfection.*

*Also available for MicroSmart and FertiSmart from 2023

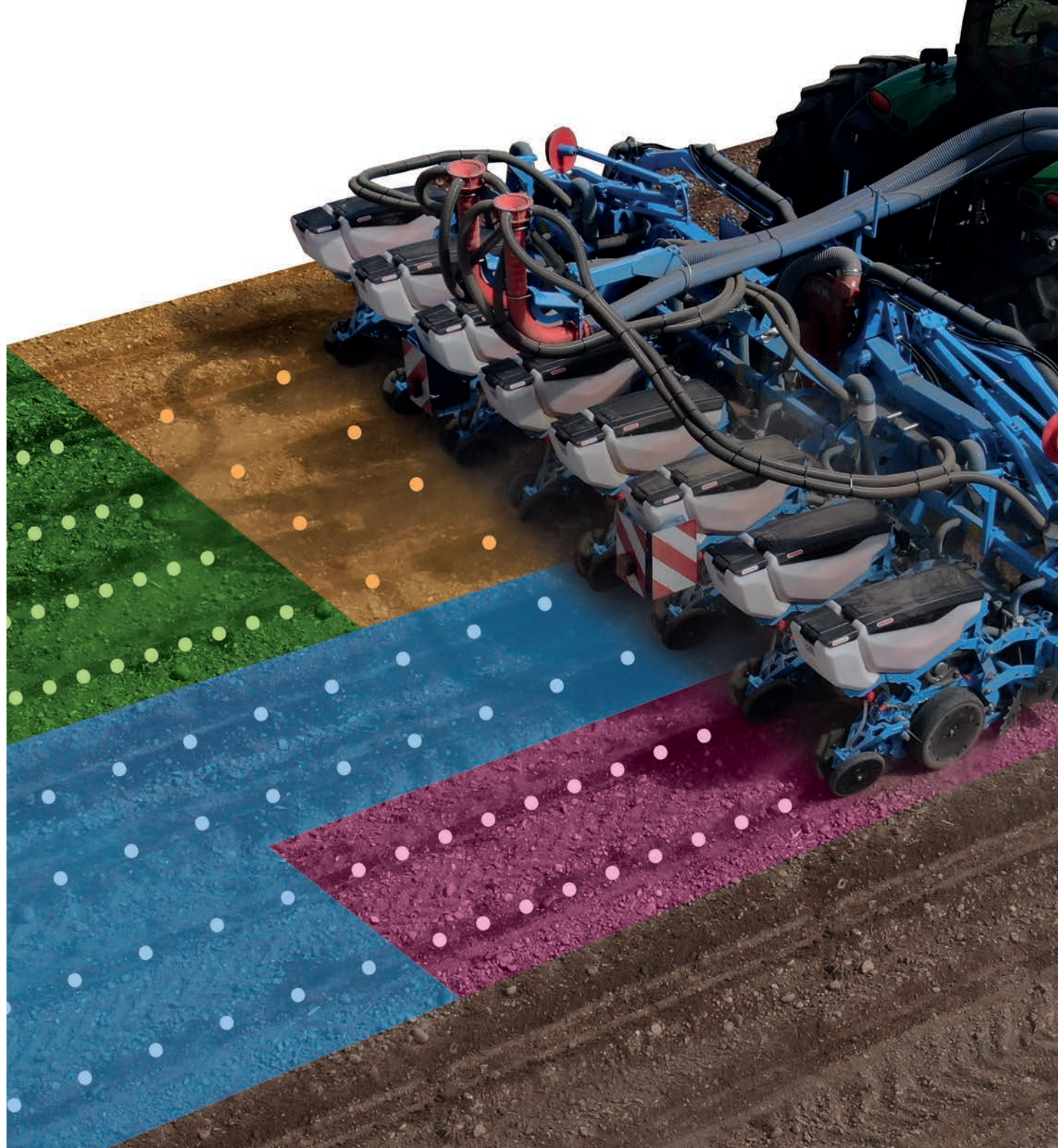

MONOSEM TC-SC



NO OVERLAPS!

Eliminating overlaps, saving on inputs and making subsequent crop operations easier are all smart solutions for driving operating efficiency and sustainability!

Managing overlaps is now a standard feature. Besides enabling you cut back on seeds and inputs, it also helps you manage cultivator runs much more effectively.

ValoTerra's Isobus technology includes a GPS device that enables you to manage row cut-off for up to 24 rows.

The on-board terminal screen displays the cut-offs using a variety of colours and shadings for a clearer overview. What's more, when a row is cut off, a sound is emitted to notify the operator.



Monosem Touch Pro Isobus terminal



TECHNOLOGY ENHANCING EASE OF USE AND OPERATING PLEASURE

Ease of use and operating pleasure to get the best out of precision solutions

A pledge **ValoTerra** promises to keep with its connectivity and exceptional services.





Emergence and Productivity
driving profitability



Smart solutions
promoting sustainability



Technology enhancing ease of use
and operating pleasure



ValoTerra Ultimate optimal
emergence at all speeds



MOVE UP A GEAR AND ENJOY A NEW LEVEL OF SERVICES TO MANAGE YOUR CROP OPERATIONS

01

SEEDSTAR M

02

Monosem Plus App

03

Remote Display Access

04

Cloud, JDLink & Operations Center

SEEDSTAR M

ValoTerra software is used to control and monitor planting operations and complies with the **Isobus** standard. You can therefore control your planter from a terminal that is **Isobus** compatible, such as the **Monosem Touch Pro, Touch** and **Touch Mini** consoles.

This user-friendly and intuitive software enables you to set and control seed distribution, as well as monitor planting quality in real time.

You can now enjoy controlling and monitoring your fieldwork with our ergonomic and information-rich software.



MAIN FEATURES OF THE SEEDSTAR M

- Tramlines
- Target density
- Actual density
- Working speed
- Hopper filling indicator
- Seed drop precision monitoring (spacing coefficient)
- Seed metering quality monitoring (omissions, duplicates)
- Seed, fertiliser and microgranulate metering controlled from the terminal
- Settings library for all inputs (product calibration is saved in the software)
- Compatible with TC-GEO (variable rate) and TC-SC (section control) for all products applied

It goes without saying that **ValoTerra** software guarantees a new level of services. Enjoy discovering these services over the next few pages.

THE MONOSEM PLUS APP

With the **Monosem Plus** app, control seed metering and unit calibration from your smartphone, without being in the tractor cab!



FULL CONTROL USING YOUR SMARTPHONE

The long wait for ultimate operating comfort is over thanks to the **Monosem Plus app**.

Installed on your smartphone, **Monosem Plus** hands you control over each seed metering box.



A **WDS** (Wireless Data Server) added to the seed planter's architecture enables you to run diagnostics on each row** from your smartphone using "WiFi Direct".



Available in
Google Play

Available in App Store
from 2023

**The Monosem Plus version available in 2022 will only control the metering box

MONOSEM
Enhanced precision

REMOTE DISPLAY ACCESS

Stay connected to your machine, even away from the field!

What could be more convenient and reassuring than having constant remote access to your seed planter's nerve centre?



This feature is available by installing an optional **MTG** (*Modular Telematic Gateway*) module, which sends data over the cellular network.

It works thanks to the function **RDA** (*Remote Display Access*) solution.



REMOTE UPDATING

With the **MTG module** (*Modular Telematic Gateway*) installed on your planter, you can manage any maintenance operations required on your machine remotely and download updates.

CLOUD MyJohnDeere.com

The cloud can be accessed by anyone, anywhere!*

You can use the **MyJohnDeere.com** cloud solution to store management data for your fields and **Monosem** equipment.

This cloud is accessible to absolutely everyone!

Anyone can set up an account, register and use this data storage hub free of charge.

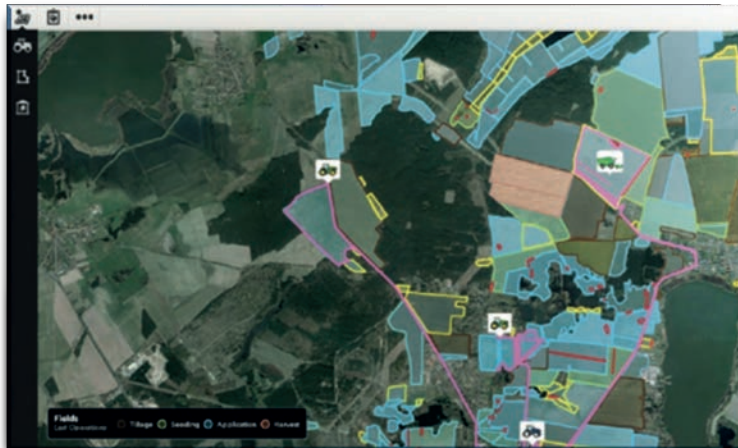

*Compatible with Monosem Touch Pro, John Deere 4640 and 4600 terminals

The Cloud MyJohnDeere.com

JDLINK

Operations Center

TWO COMPLEMENTARY YET UNIQUE APPLICATIONS

The **Operations Center** application hosted by **MyJohnDeere.com** can help you manage the documentation of agronomic data for your fields.

Parallel to this, the **JDLINK** application offers technical management solutions for your **Monosem** equipment.

TWO-WAY INTERACTION FOR COMFORT AND PEACE OF MIND!

Monosem's unique brand of precision farming is not only about collecting agronomic data. It also focuses on the interaction between equipment owners and their machines.

This interaction is key to optimising settings, managing field work and reducing maintenance costs.

Monosem precision farming pays specific attention to two-way communication between machinery and the cloud, and therefore the owner.

This communication offers ease of use and productivity gains that surpass your standard precision farming solutions.

JDLink

HELPING YOU MANAGE YOUR MONOSEM EQUIPMENT

As well as storing information about your equipment, such as serial numbers, product names, configurations and settings, the **JDLink** system also offers you countless other advantages.

TRANSFER OF TECHNICAL DATA FROM THE PLANTER... TO MONITOR YOUR EQUIPMENT IN REAL TIME!

Technical data including alerts, maintenance plans and location data are transferred in real time by the optional **MTG** (*Modular Telematic Gateway*) module installed on the planter.

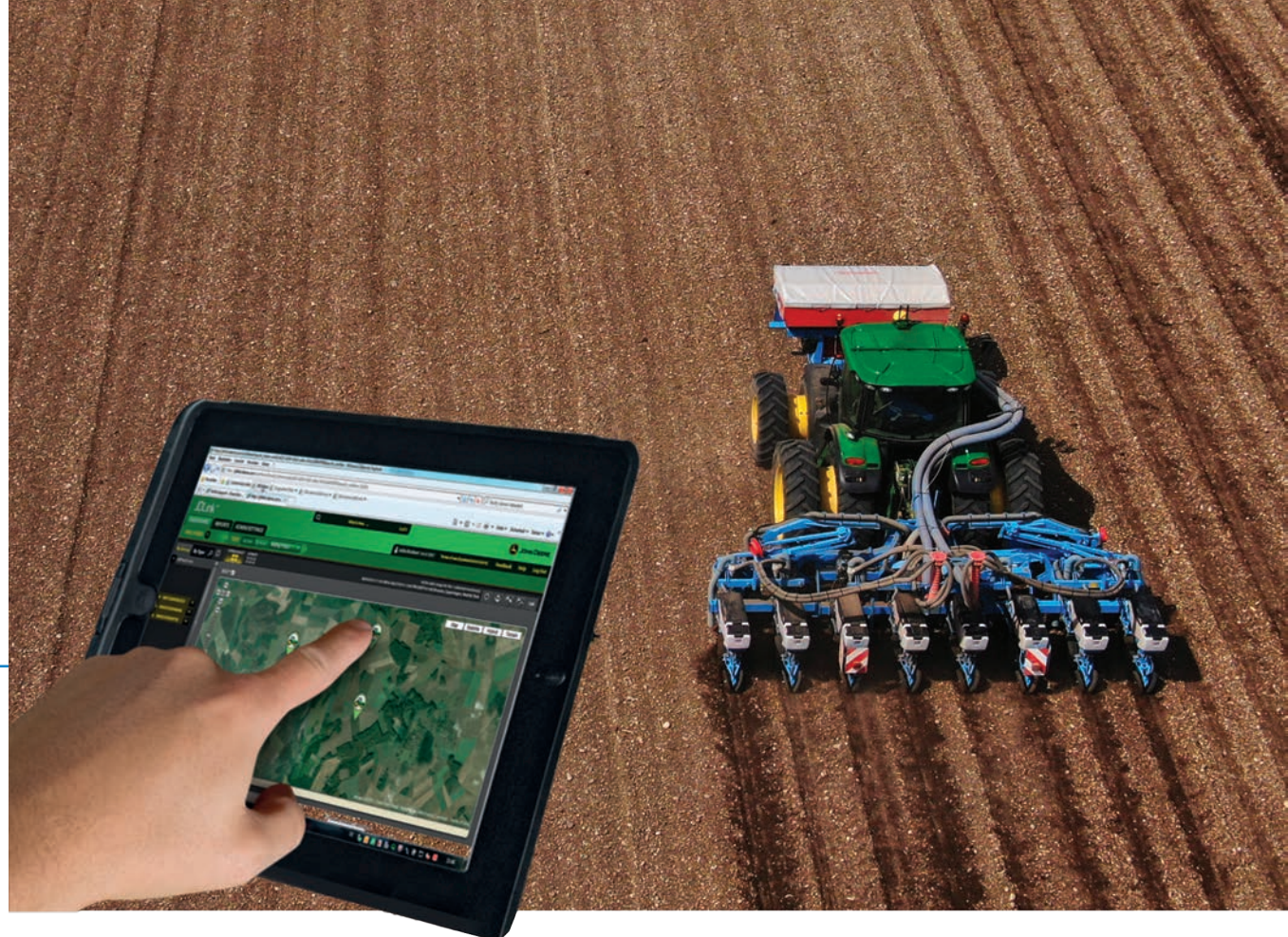

AN AGILE SOLUTION OFFERING COUNTLESS POSSIBILITIES

- Track your equipment's location in real time
- View the movements log
- Receive alert messages from the **DTC** (*Diagnostic Trouble Code*) alert system by email or text message if technical faults are detected
- Receive real-time alerts if your planter travels outside of an area you have pre-defined
- Receive alerts if your planter is used outside of a time window you have pre-defined
- Receive maintenance recommendations for your equipment
- Update your planter software remotely by authorising access to your technical support

Operations Center

HELPING YOU DOCUMENT AGRONOMIC DATA

Besides enabling you to save general information on clients and fields, **Operations Center** is also a powerful documentation, mapping and traceability tool.



TWO-WAY INTERACTION FOR CONVENIENCE AND PEACE OF MIND!

Enjoy browsing through data such as seed variety, target planting density, actual density, metering rate, seed spacing and variation rates, and working speed.

What's great is that your data can be processed in the **Operations Center** whatever your tractor brand.

There are also solutions for exporting data and using prescription maps on **Monosem** planters, provided that tractors are appropriately equipped.

Don't hesitate to contact your **Monosem** dealer for further information.

THREE DATA TRANSFER OPTIONS



MANUAL TRANSFER USING A USB MEMORY STICK

Manually transfer your crop data from any tractor terminal to the **Operations Center** using a compatible USB memory stick (make sure the terminal has a USB port).



TRANSFER USING A WIFI HOTSPOT

This type of data transfer is easy if you are equipped with a **Monosem Touch Pro** box or a **John Deere 4640** terminal. As soon as you are near a WiFi hotspot, your data is automatically sent to the **cloud**.

Solutions combining an **MDT** (*Mobile Data Transfer*) USB stick and a smartphone installed with a **WDT** (*Wireless Data Transfer*) app are available for any other on-board computers, regardless of the tractor brand.



TRANSFER DATA TO THE CLOUD IN REAL TIME

The ideal solution for tractors or terminals equipped with their own **MTG** (*Modular Telematic Gateway*) module.

As you've probably noticed, our versatile system is compatible with countless solutions to meet every need!



VALOTERRA ULTIMATE OPTIMAL EMERGENCE AT ALL SPEEDS

With its new brush-based seed guidance system, the **ValoTerra Ultimate** ensures optimal planting consistency and depth at speeds of **2 to 18 km/h**, resulting in fast and uniform shoot emergence!





Emergence and Productivity
driving profitability



Smart solutions
promoting sustainability



Technology enhancing ease of use
and operating pleasure



**ValoTerra Ultimate optimal
emergence at all speeds**



SPEED IS NO LONGER AN ISSUE!

- 01 Active Seed Guidance (ASG)
- 02 SmartAccess
- 03 ValoTerra Ultimate

HIGH-SPEED PLANTING IS ONLY VIABLE IF IT IS FULLY CONTROLLED!

High-speed precision planters are perfectly equipped to meet requirements in terms of fertilizer output, crop diversity and performance at low and medium speeds.

With the ValoTerra Ultimate, speed is no longer a barrier to achieving optimal emergence:



TOP PERFORMANCE AT LOW, MEDIUM AND HIGH SPEEDS

Planting speeds of **4 to 18 km/h** are possible with the ASG system!



CROP DIVERSITY

The **ASG system** can be swapped for a chute to plant a wide range of crops



HIGH FERTILIZER OUTPUT

The FertiSmart distribution unit can apply up to **450kg/ha!**

Active Seed Guidance (ASG*)

THE NEW ASG SEED GUIDANCE SYSTEM HAS BEEN DEVELOPED BASED ON OUR ZERO-GRAVITY CONCEPT!

Our guidance system controls all stages of the seeds' journey, from the seed disc to the cellular loading wheel and finally, the conveyor outlet.

Back rolling is controlled, the seed ejection speed is proportionate to the tractor's working speed, and spacing in the furrow is kept consistent on both flat and uneven ground.

This means that speed is no longer an issue, since each seed is positioned precisely at speeds of 2 to 18 km/h.

* ASG Ready will be available for Wingfold frames from 2023. The ASG system will be available for purchase from 2025.



Scan here to see the **Active Seed Guidance** system in action!

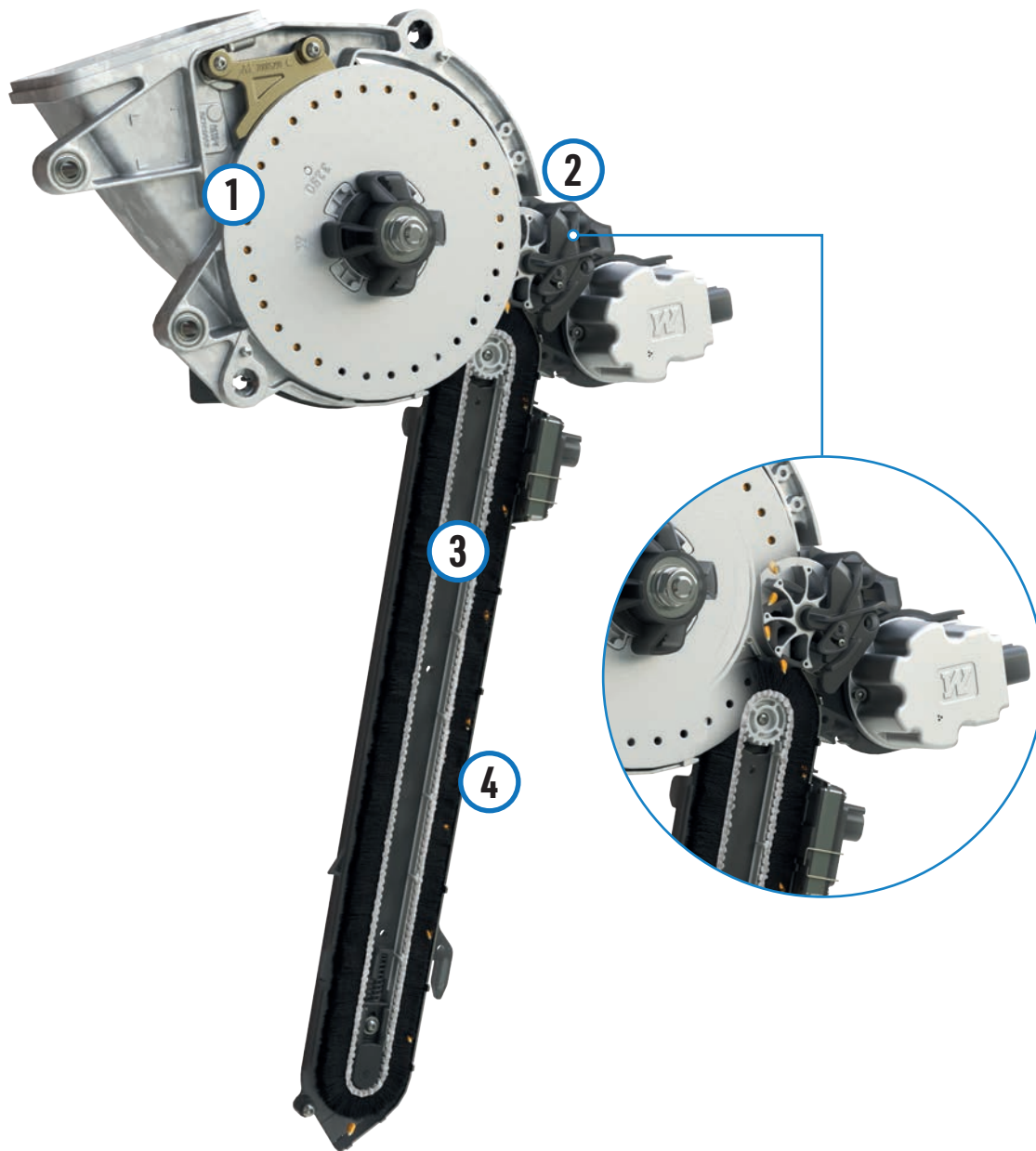

INSIDE THE INNOVATIVE ASG SYSTEM

THE SEED GUIDANCE SYSTEM THAT ADAPTS TO YOUR PLANTING SPEEDS...

1: VACUUM-BASED METERING BOX

The vacuum-based seed metering system ensures planting precision and versatility.

The metering box is equipped with smooth discs, a patented insert and electric drive, all of which help increase precision at higher speeds.

2: CELLULAR LOADING WHEEL

Seeds are supplied to the cellular loading wheel, which then inserts them in the brush conveyor using a system of guiding rods.

The system only allows high-precision insertion of seeds in the brush conveyor, which conveys them to the furrow.

3: POSITIVE DRIVE BELT

The brush conveyor belt is grooved to ensure optimal alignment, perfect rotation, and minimal wear.

4: BRUSH CONVEYOR

The rotating brush conveyor guides seeds to the furrow at a rate proportionate to the tractor's working speed, eliminating any bumps and vibrations.

This is a precision solution ensuring accurate and consistent seed placement in the furrow.



Smart Access

CROP DIVERSITY IS NO LONGER AN ISSUE



SMART ACCESS

- The SmartAccess system offers exceptional versatility by allowing you to swap ASGs for chutes, so you can plant a wide variety of seeds.
- Crops are changed by changing discs, which takes less than a minute per metering unit!

«JUST CHANGE THE DISK ! »

As with existing systems, there's no need to remove any ejection wheels or pressure/vacuum adjustment grilles. Just change the disc!



Scan here to see the **SmartAccess** system in action!



AN INTERCHANGEABLE SYSTEM

It takes less than 2 minutes per row to switch from the conveyor system to the chute system!

FERTILIZER APPLICATION IS NO LONGER AN ISSUE WITH FERTISMART!



FERTISMART

Limited fertilizer distribution capacity is no longer an issue with **FertiSmart**, the new fertilizer unit that pneumatically applies up to **450kg/ha** from an 8-row planter (with 75cm inter-row spacing) at 15 km/h!

The **FertiSmart** unit provides optimum performance whatever the terrain, slopes included, even where demanding fertilizers are concerned.

MICROSMART: THE KEY TO ULTRA-PRECISION AGRICULTURE

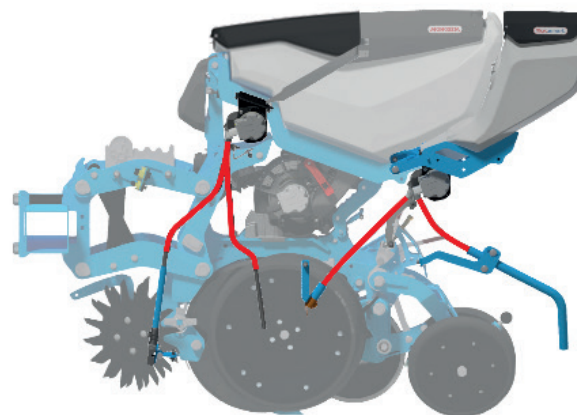

MICROSMART

This system ensures highly consistent application of plant protection and nutrition products at any operating speed. Besides applying products accurately, the new **MicroSmart** microgranulator is equipped with 4 positioning lines capable of applying two products simultaneously (e.g. starter fertilizer and pesticides) from 2 separate hoppers per metering unit!

* 2 lines available from 2023 and 4 lines available from 2024

ValoTerra Ultimate

YOUR KEYS TO SUCCESS:

INCREASED PRODUCTIVITY

- Maximum precision at all working speeds with the largest opener discs and gauge wheels on the market
- Fertilizer is applied at the required rate without any limit on speed with the **FertiSmart** system (up to 450kg/ha)
- The innovative **SmartAccess** system makes cleaning easier, enabling significant time savings
- Working speed can be adjusted from 4 to 18 km/h with the **ASG** system, boosting your productivity
- Discs can be changed in less than a minute per row
- Depth control components can be adjusted quickly without tools

ULTIMATE VERSATILITY

- The drop chute can be exchanged for the **ASG** conveyor depending on the type of seeds used
- The **FertiSmart** distribution unit handles undulating and sloping land, and can therefore be used in any planting conditions
- The **FertiSmart** distribution unit is compatible with a wide variety of fertilizers (bulk-blends, organic fertilizers, granulate, etc.)
- With ground pressure of up to 325kg, the **ValoTerra Ultimate** adapts to all soil types
- Working speed can be adjusted to operating conditions (in terms of soil, weather, gradient, etc.)





ENVIRONMENTAL BENEFITS

- With the **MicroSmart** multi-line* distribution system, 2 different microgranule types can be applied in exactly the right place using 4 available application lines
- Up to 7% savings can be made on inputs through variable rate control across the working width and row-by-row section-control (**FertiSmart & MicroSmart**)
- A full record is kept of fertilizer and microgranule quantities applied (data are saved on **MyJohnDeere.com**)

* 2 lines available from 2023 and 4 lines available from 2024



EASE OF USE

- Metering precision can be adjusted using the new **Monosem Plus** app on your smartphone with «WiFi Direct»
- The ISOBUS-compatible **ValoTerra** software is simple and intuitive, providing a convenient way of managing planting operations
- The ValoTerra's on-board technology provides an easy way of documenting and managing crop operations
- Real-time machine-driver communication
- Settings can be adjusted easily in the tractor cab

ValoTerra

Range and main equipment items

MODELS		MB 260 6R ST 70/75/80	TFC2 8R 70/75/80	TFC2 9R 55/60	TFC2 12R 45	TFC2 12R 50	WingFold 2 70/75/80
PLANTER	Row unit type	VALOTERRA	VALOTERRA	VALOTERRA	VALOTERRA	VALOTERRA	VALOTERRA ULTIMATE
	Number of rows	6	8	9	12	12	8
	Inter-rows	70/75/80	70/75/80	55/60	45	50	70/75/80
	Working width	4M20-4M80	5m60-6m40	4m95-5m40	5m40	6m00	5m60-6m40
	Transport width	3M50	3m00	3m00	3m00	3m00	3m00-3m40
FERTILISER UNIT	FertiSmart on planter	980L	1350L	-	-	-	1350L
	Equipment for front-mounted fertiliser units	STD	STD/DUO	STD	STD/DUO	STD/DUO	-
MICROSMART	MicroSmart AR	20L	20L	20L	20L	20L	20L

Main options

Microgranulator, Fertiliser units, Isobus terminals

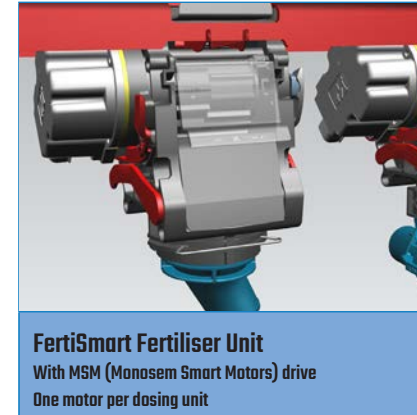

MONOSEM

Enhanced precision

15 rue Beaujon - 75008 Paris - France

+33 (0)549 815000



Business no.: 303953566 - R.C.S. Paris

Reference no.: 92800EN

www.monosem.com

All the information concerning the different types of equipment, including external appearance, weight and dimensions, was correct at the time of printing and may vary from country to country. The information may be modified by us without prior notice. This document may not be regarded as a binding in any way. Your Monosem dealer will certainly notify you of any changes. To illustrate this document, certain protective devices may have been removed from equipment. However, this remains exceptional. As indicated in the user instructions, these devices should never be removed.

Printed by: Prouteau Imprimerie Bressuire / Photo Credits: Monosem, Shutterstock



IMPRIM'VERT®

Monosem is committed to the environment **MonoGreen**