

SPARE PART LIST

**TURBO JET SUPER 8
TP0830IN**

**Hydraulic drive
STANDARD**

Version 03/2024

PROFI – Control unit



Technik-Plus

Firma „Technik-Plus Sämaschinen e.U.“
Industrieparkstrasse 6-8
8480 Mureck
Österreich
Tel: +43 347221120

E-Mail: technik-plus@technik-plus.eu

E-Mail: office@technik-plus.eu
www.technik-plus.eu





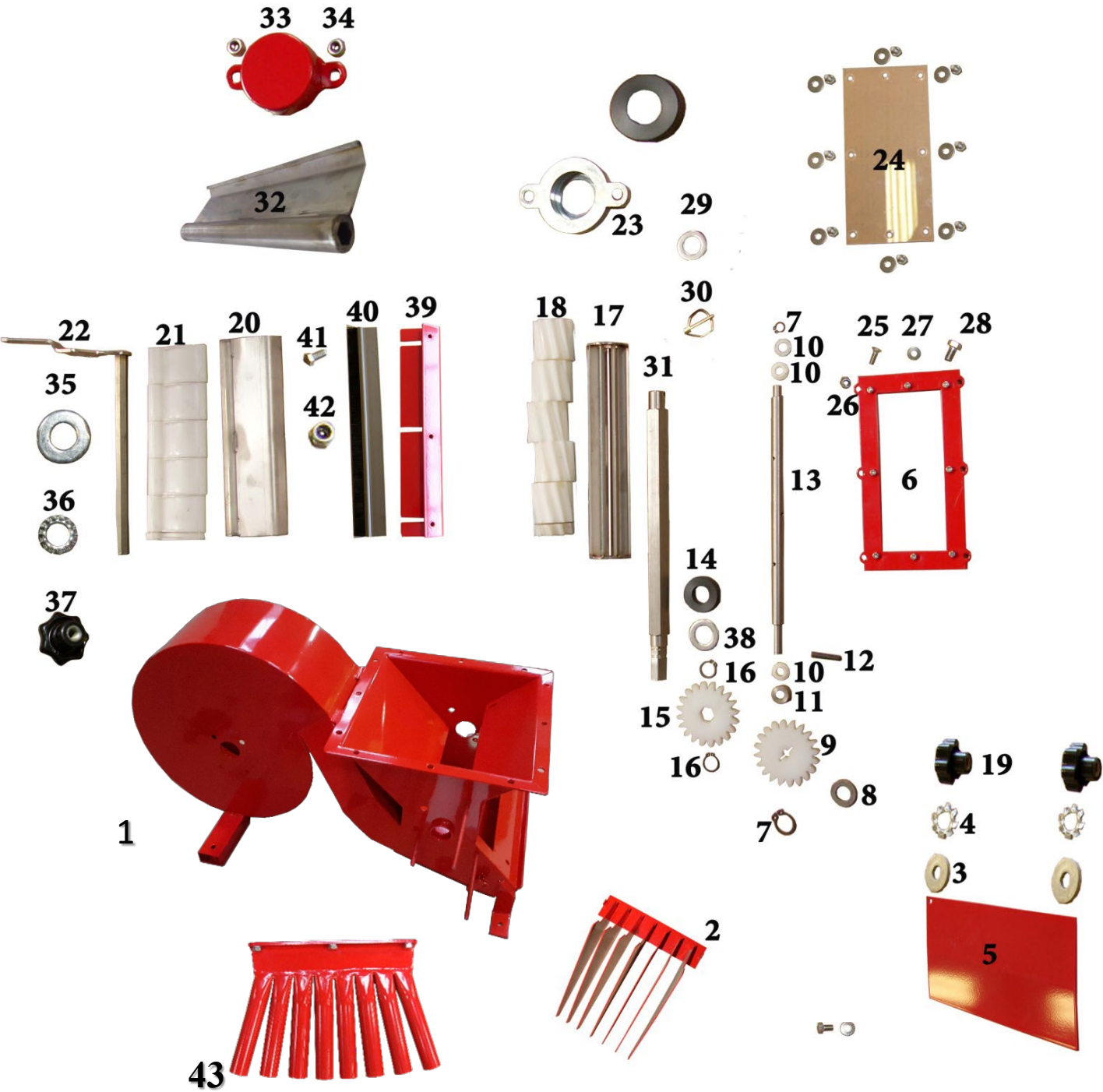

SPARE PART LIST





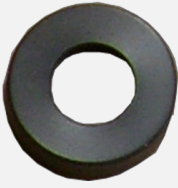

TURBO JET SUPER 8







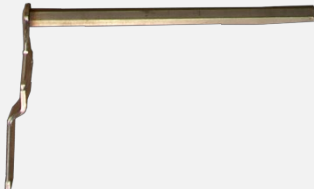

**Hydrauc drive
STANDARD**



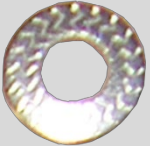



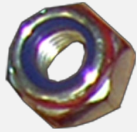

Nr	Product name	Spare part	Picture
01	Frame (dosing unit)	10528884	
02	Lamella unit year of manufacture 2012 from year of manufacture 2013	10529803 10528803	
03	Washer M8,4 24x2 A2	10537621	
04	Geared washer M8,4	10537634	
05	Seed roll cover	10529728	
06	Frame for window	10529802	
07	Lock ring 10x1	10539945	
08	Washer 20 x 10,5 x 2 A2	10539731	

Nr	Product name	Spare part no	picture
09	Gear S=10, DM=10	10519955	
10	Plastic bearing for agitator I-DM=10,2; A-DM=19,7; s=7	10519808	
11	Distance bush I-DM: 10,1 A-DM: 20, S=12	10529812	
12	Splint 3x40 for agitator A2	10539923	
13	Agitator	10619911	
14	Plastic bearing for seed roll I-DM:20; A-DM:42,5 S:12	10519812	
15	Gear with inlet hexagon	10519839	
16	Lock ring 18x1,2	10539824	

Nr	Product name	Spare part no	picture
17	Metal seed roll	10529921	
18	Standard seed roll	10519825	
19	Star knob	10539885	
20	Bottom flap without stipe (Stainless steel)	10529060	
21	Bottom flap (plastic)	10519995	
22	Hexagon axle with lever	10529985	
23	Bearing bracket	10529994	
24	Acrylic glass 201 x 99	10519983	

Nr	Product name	Spare part no	picture
25	Screw M4 x 12 A2	10539801	
26	lock nut M4 A2	10539694	
27	Thrust washer M5 A2	10539993	
28	Thrust washer M5 x8 A2	10539806	
29	Washer galvanized M20	10539675	
30	Locking pin	10529634	
31	Hexagon wheel (for seed roll TP08)	10529806	
32	Bottom flap with stipe stainless steel	10529431	

Nr	Product name	Spare part no	picture
33	Agitator cover	10529962	
34	Lock nut M8 galvanized	10539905	
35	Washer 8,4x24x2 A2	10537621	
36	Geared washer M8 A2	10539741	
37	Star knob M8 galvanized DM40	10539901	
38	Washer 20x28x1 A2	10537627	
39	Bracket for brush	10529712	
40	Brush	10619841	

36	Product name	Spare part no	picture
41	Screw brush M5x10 Niro (A2)	10539673	
42	Lock nut M5 (Niro)A2	10539917	
43	Hexagon screw for Lamella until M8x12	10537633	
44	Washer M8 f lamella galvanized	10539902	
45	Pipe register TP08	10529314	









SPARE PART LIST

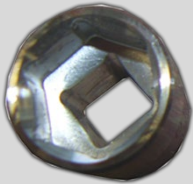





TURBO JET SUPER 8 TP0830IN



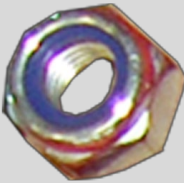

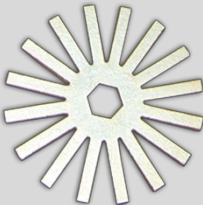

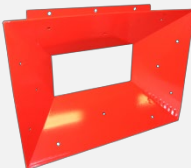

Hydraulic drive STANDARD





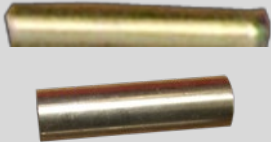

Nr	Product name	Spare part no	picture
1	Blower wheel diam 380mm	10529958	
2	Screw for the blower wheel	10539876	

Nr	Product name	Spare part	picture
3	Nut 17x3/8	10529960	
4	Cable connector	10539990	
5	Spring ADM=26,5, H=14; S=1,8 W=3 stainless steel	10539978	
6	Hopper trapeze small 300 x 120	10529809	
7	Hopper trapeze big 460 x 120	10529810	
8	Hexagon screw M6x20 galvanized	10539981	
9	Thrust washer M6	10539984	
10	Distance washer M6,5x3x17	10539985	

Nr	Product name	Spare part no	picture
11	Lock nut M10	10539908	
12	Motor plate	10528579	
13	Counting wheel	10529954	
14	Screw M5x10 galvanized	10539742	
15	Cover for Blower wheel	10529817	
16	hopper cone	10529815	
17	Spreader plate DM 30mm Spreader plate DM 25 mm	10529130 10529196	
18	Rubber seal	10579909	

Nr	Product name	Spare part no	picture
19	Seed roll motor	10569909	
20	Cover seed roll motor	10529811	
21	End spice	10539994	
22	Plug 2 -pin	10537640	
23	Screw M10x25	10539909	
24	Lock nut M10 galvanized	10539908	
25	Distance bush L=77; ADM=13 Distance bush L=63mm, ADM=14	10529804 10529992	
26	Ring to cover	10519947	

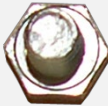
Nr	Product name	Spare part no	picture
27	Cover	10519948	
28	Sensor holder	10529124	
29	Hopper 300lit	10519916	
30	screw	10537619	
31	Locking washer	10539993	
32	screw	10537637	

SPARE PART LIST

TURBO JET SUPER 8

Hydraulic drive PROFI control unit

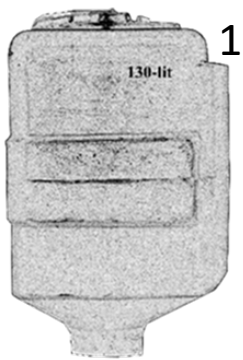

1

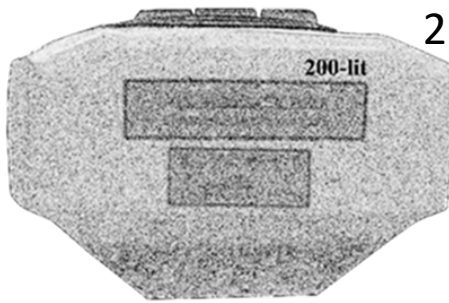

2

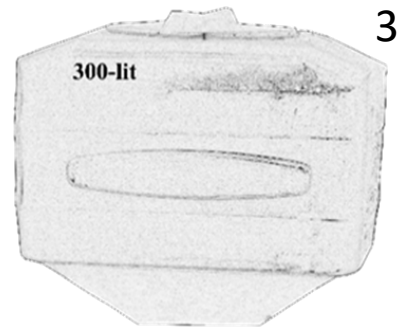

3

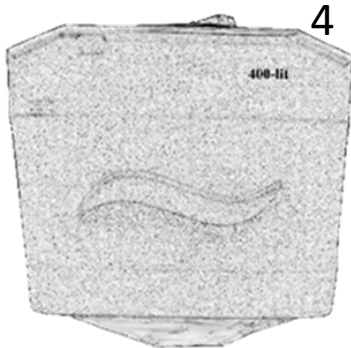

4

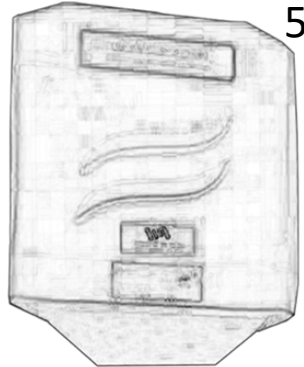

5

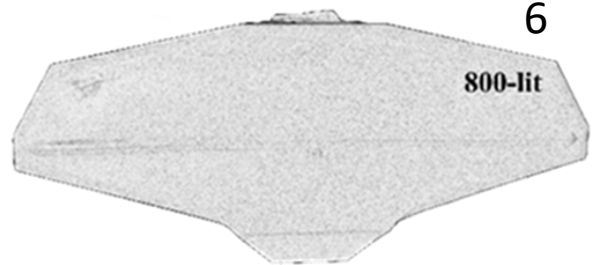

6

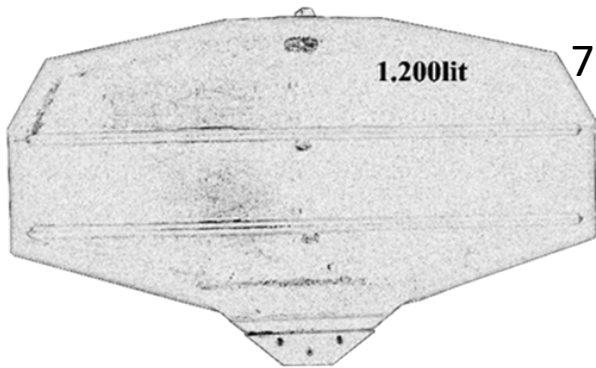

7

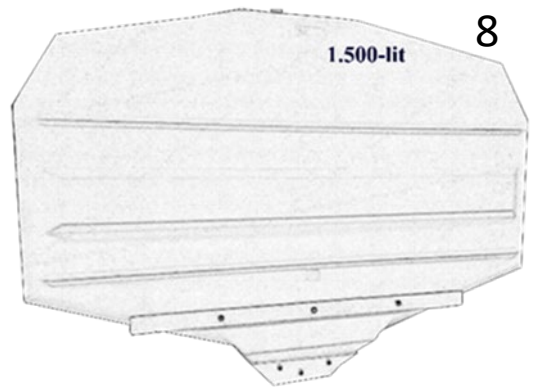

8

Nr	Product name	Spare part no	picture
1	Hopper 130-lit	10519904	
2	Hopper 200-lit	10519829	



Nr	Product name	Spare part no	picture
3	Hopper 300-lit	10519916	 <p>A small, rectangular hopper with a handle on the front. The text "300-lit" is printed on the top right corner.</p>
4	Hopper 400-lit	10519917	 <p>A rectangular hopper with a handle on the front. The text "400-lit" is printed on the top right corner.</p>
5	Hopper 500-lit	10519918	 <p>A rectangular hopper with a handle on the front. The text "500-lit" is printed on the top right corner.</p>
6	Hopper 800-lit	10519988	 <p>A larger rectangular hopper with a handle on the front. The text "800-lit" is printed on the top right corner.</p>
7	Hopper 1.200-lit	10519555	 <p>A large rectangular hopper with a handle on the front. The text "1.200lit" is printed on the top right corner.</p>
8	Hopper 1.500-lit	10519807	 <p>A large rectangular hopper with a handle on the front. The text "1.500-lit" is printed on the top right corner.</p>

SPARE PART LIST

**TURBO JET SUPER 8
TP0830IN**

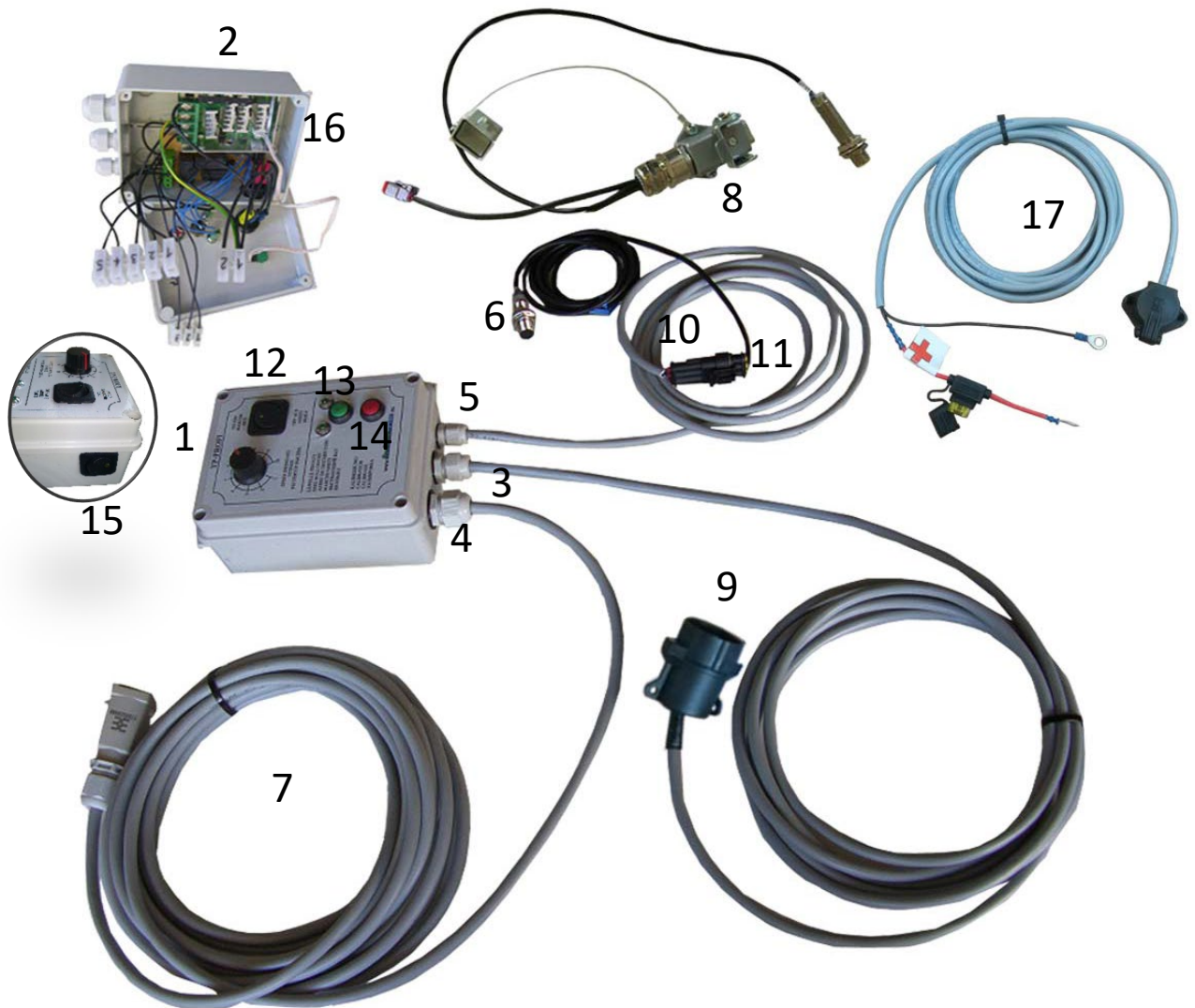
**Hydraulic drive
PROFI control unit**



Nr	Product name	Spare part no	picture
1	Control unit	10589939	
2	Fuse 15 A blue	10539863	

Nr	Product name	Spare part no	picture
3	Cabel screw PG9 + nut	10519963	
4	Cabel screw PG11 + nut	10519964	
5	Cabel screw PG7 + nut	10519827	
6	On/OFF sensor with cable and plug	10639904	
7	Control unit cable length: 7m	10617656	
8	Plug complete	10619948	
9	4-pin plug, black	10519958	
10	Plug	10619985	
11	Socket	10619984	

Nr	Product name	Spare part no	picture
12	ON/OFF switch	10599901	
13	Push button green 12V	10599908	
14	Push button red	10599961	
15	Sensor switch	10599949	
16	Circuit board with poty	10549904	
17	Battery cable, length 3.5m	10619960	
18	5-pin plug (professional control)	10619947	

SPARE PART LIST TP0830IN





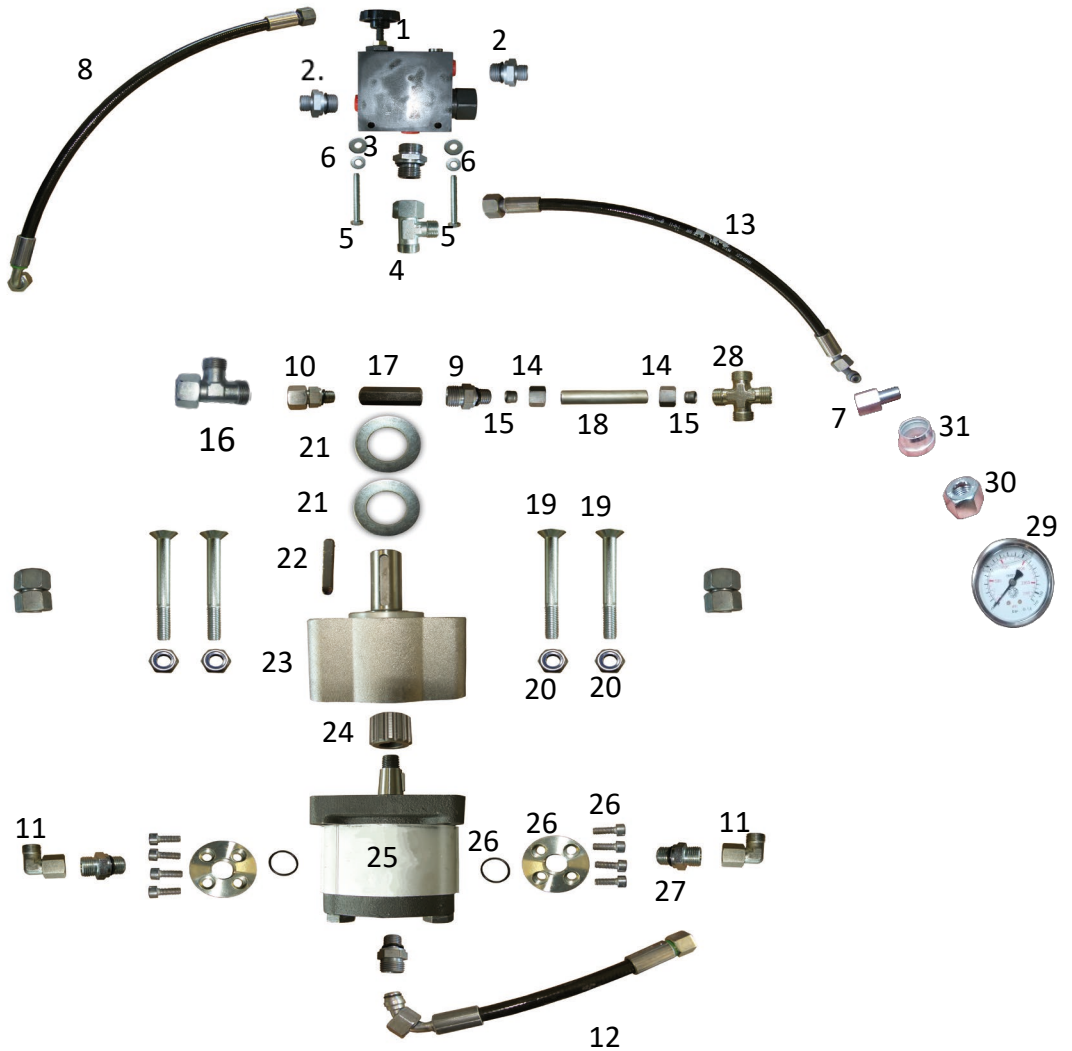

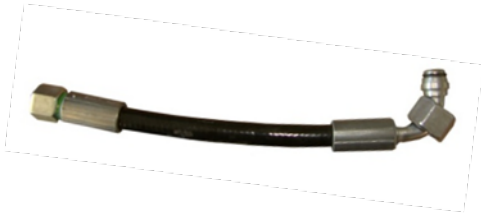

TURBO JET SUPER 8

Hydraulic drive STANDARD





Nr	Product name	Spare part no	picture
1	Valve	10569942	
2	screw connection	10549948	

Nr	Product name	Spare part no	picture
3	screw connection	10549948	
4	T-screw connection	10549932	
5	Hexagonal screw M6x50 galvanized	10539884	
6	Locking washer	10539984	
7	Manometer screw connection	10549808	
8	Hydraulic line	10549987	
9	screw connection	10549925	
10	screw connection	10549998	
11	Protractor screw connection	10549939	

Nr	Product name	Spare part no	picture
12	Hydraulic line	10549785	
13	Hydraulic line	10549787	
14	Union nut	10549949	
15	Cutting ring	10549950	
16	T-screw connection	10549941	
17	Check valve	10556943	
18	Hydraulic pipe	10549954	
19	Hexagon socket screw with countersunk head M10x90Vz	10539975	
20	Stop nut M10 galvanized	10539908	

Nr	Product name	Spare part no	picture
21	washer	10539890	
22	Wedge for front bearing	10529225	
23	Attachment bearing	10569917	
24	gear	10569918	
25	Hydraulic motor	10569958	
26	Pump flange	10549812	
27	Screw connection	10549924	
28	Cross screw connection	10549806	

Nr	Product name	Spare part no	picture
29	Manometer	10549809	
30	Union nut	10549949	
31	Cuting ring	10549950	



Technik-Plus