

# SPARE PART LIST

**TURBO JET SUPER 8**  
Reinforced turbine with  
6.500 rpm

**ELECTRIC DRIVE**

**SEEDER+ STEUERUNG**

**VERSION 02/2024**



**Technik-Plus**

Firma „Technik-Plus Sämaschinen e.U.“  
Industrieparkstrasse 6-8  
8480 Mureck  
Österreich  
Tel: +43 347221120







E-Mail: [office@technik-plus.eu](mailto:office@technik-plus.eu)  
[www.technik-plus.eu](http://www.technik-plus.eu)

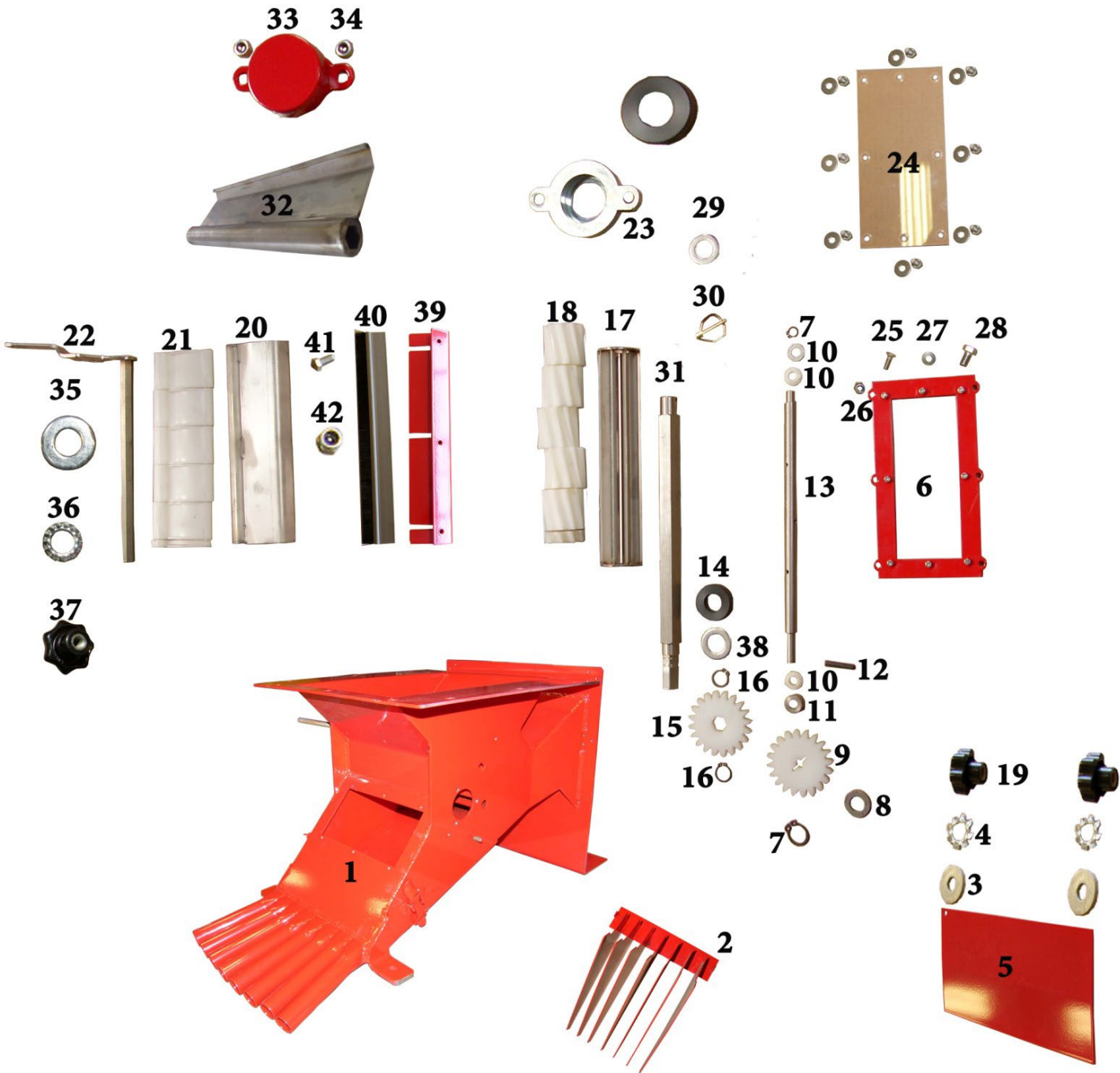

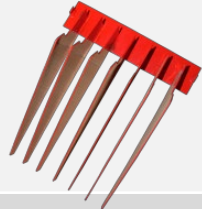



# SPARE PART LIST

**TURBO JET SUPER 8**  
Reinforced turbine  
6.500 rpm





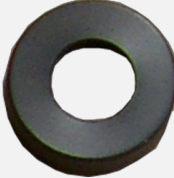

**ELECTRIC DRIVE**







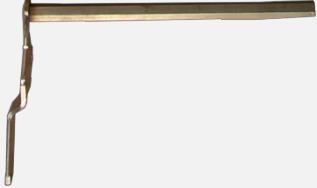





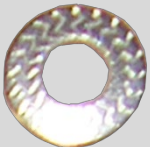



Nr	Product name	Spare part no	picture
01	<b>Frame (Dosing unit)</b>	10529917	
02	<b>Lamella until year of manufacture 2012 from year of manufacture 2013</b>	10529803 10528803	
03	<b>Washer M8,4 24x2 A2</b>	10537621	
04	<b>Geared washer M8,4</b>	10537634	
05	<b>Seed roll cover</b>	10529728	
06	<b>Frame for window</b>	10529802	
07	<b>Lock ring 10x1</b>	10539945	
08	<b>Washer 20 x 10,5 x 2 A2</b>	10539731	

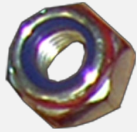

Nr	Product name	Spare part no	picture
09	<b>Gear</b> S=10, DM=10	10519955	
10	<b>Plastic bearing for agitator</b> I-DM=10,2; A-DM=19,7; s=7	10519808	
11	<b>Distance bush</b> I-DM: 10,1 A-DM: 20, S=12	10529812	
12	<b>Splint 3x40</b> for agitator A2	10539923	
13	<b>Agitator</b>	10619911	
14	<b>Plastic bearing for seed roll</b> I-DM:20; A-DM:42,5 S:12	10519812	
15	<b>Gear with inlet hexagon</b>	10519839	
16	Lock ring 18x1,2	10539824	



Nr	Product name	Spare part no	picture
17	Metal seed roll	10529921	
18	Standard seed roll	10519825	
19	star knob	10539885	
20	<b>Bottom flap without stipe</b> (Stainless steel)	10529060	
21	<b>Bottom flap</b> (plastic)	10519995	
22	<b>Hexagon axle with lever</b>	10529985	
23	<b>Bearing bracket</b>	10529994	
24	<b>Acrylic glass</b> 201 x 99	10519983	

Nr	Product name	Spare part no	picture
25	<b>Screw</b> M4 x 12 A2	10539801	
26	<b>lock nut</b> M4 A2	10539694	
27	<b>Thrust washer</b> M5 Stainless steel	10539993	
28	<b>Thrust washer</b> M5x8 A2 Stainless steel	10539806	
29	<b>Washer galvanized M20</b> for seed roll	10539675	
30	<b>Locking pin</b>	10529634	
31	<b>Hexagon wheel</b> (for seed roll TP08)	10529806	
32	<b>Bottom flap with stipe</b> stainless steel	10529431	

Nr	Product name	Spare part no	picture
33	<b>Agitator cover</b>	10529962	
34	<b>Lock nut M8</b> galvanized	10539905	
35	<b>Washer 8,4x24x2</b> A2	10537621	
36	<b>Geared washer M8 A2</b>	10539741	
37	<b>Star knob M8 galvanized</b> DM40	10539901	
38	<b>Washer 20x28x1 A2</b>	10537627	
39	Bracket for brush	10529712	
40	Brush	10619841	

36	Product name	Spare part no	picture
41	<b>Screw brush M5x10 Niro (A2)</b>	10539673	
42	<b>Lock nut M5 (Niro) A2</b>	10539917	
43	<b>Hexagon screw for Lamella until M8x12</b>	10537633	
44	<b>Washer M8 f lamella galvanized</b>	10539902	
45	<b>Pipe register TP08</b>	10529314	











# SPARE PART LIST

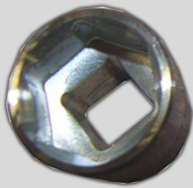





**TURBO JET SUPER 8**  
Reinforced turbine with  
6500 rpm



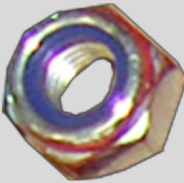

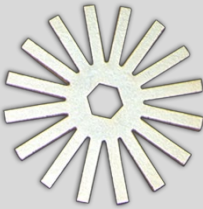

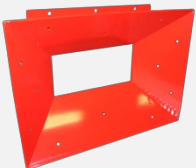

**ELECTRIC DRIVE**  
**SEEDER+ control unit**



Nr	Product name	Spare part no	picture
1	Kontrol light	10619955	
2	Socket 2-pin (grey)	10619764	

Nr	Product name	Spare part no	picture
3	<b>Nut 17x3/8</b>	10529960	
4	<b>Cable connector</b>	10539990	
5	<b>Spring ADM=26,5, H=14; S=1,8 W=3 stainless steel</b>	10539978	
6	<b>Hopper trapeze small 300 x 120</b>	10529809	
7	<b>Hopper trapeze big 460 x 120</b>	10529810	
8	<b>Hexagon screw M6x20</b>	10539981	
9	<b>Thrust washer M6</b>	10539984	
10	<b>Distance washer M6,5x3x17 galvanized</b>	10539985	

Nr	Product name	Spare part no	picture
11	<b>Lock nut M10</b>	10539908	
12	<b>Motor plate</b>	10528579	
13	<b>Counting wheel</b>	10529954	
14	<b>Screw M5x10 galvanized</b>	10539742	
15	<b>Cover double fan</b>	10529808	
16	<b>Hopper cone</b>	10529815	
17	<b>Spreader plate DM 30mm Spreader plate DM 25 mm</b>	10529130 10529196	
18	<b>Rubber seal</b>	10579909	

Nr	Product name	Spare part no	picture
19	Seed roll motor	10569909	
20	<b>Cover seed roll motor</b>	10529811	
21	<b>End spice</b>	10539994	
22	<b>Plug 2 -pin</b>	10619765	
23	<b>Screw M10x25</b>	10539909	
24	<b>Lock nut M10 galvanized</b>	10539908	
25	<b>Distance bush</b> L=77; ADM=13	10529804	
26	<b>Double fan 6500 rpm</b>	10619795	

Nr	Bezeichnungen	Ersatzteil nummer	Ersatzteil
27	cover	10519948	
28	<b>Ring for cover</b>	10519947	
29	<b>Hoper 300 lit with cover</b>	10519916	
30	<b>Connection cable</b>	10617657	
31	<b>Distance bush L=63mm, ADM=14</b>	10529992	

# SPARE PART LIST

**TURBO JET SUPER 8  
SEEDER+ control unit**

**Electric drive  
6.500 rpm**

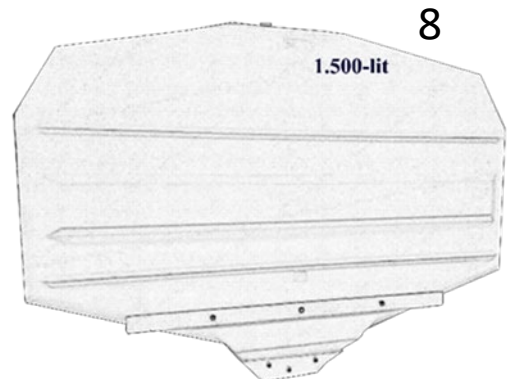
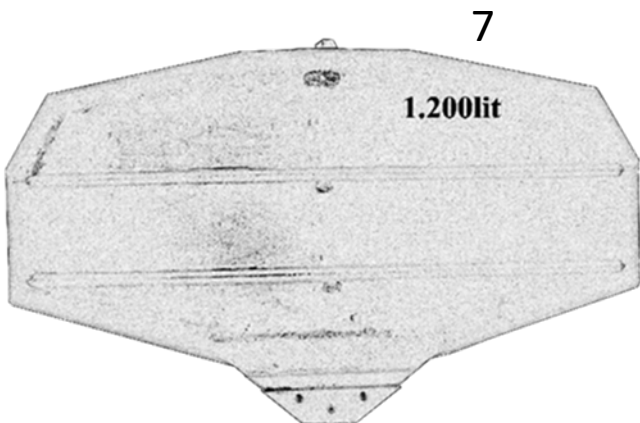
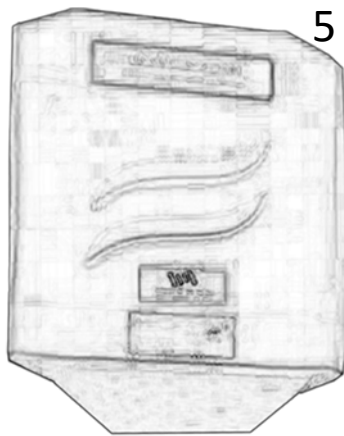
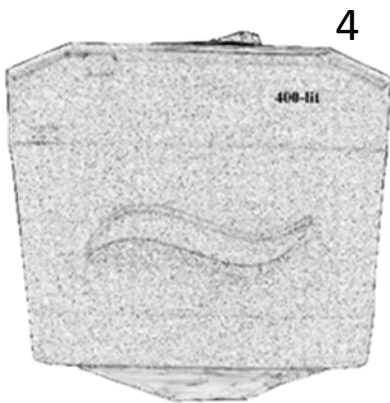
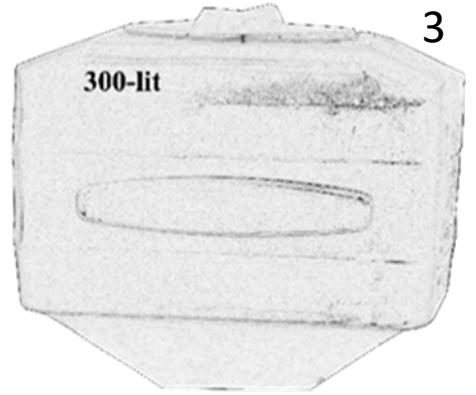
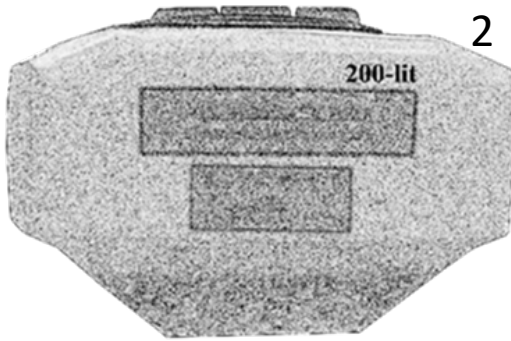
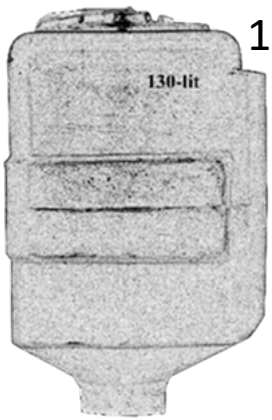



Nr	Product name	Spare part no	picture
1	Hopper 130-lit	10519904	
2	Hopper 200-lit	10519829	
3	Hopper 300-lit	10519916	
4	Hopper 400-lit	10519917	
5	Hopper 500-lit	10519918	
6	Hopper 800-lit	10519988	
7	Hopper 1.200-lit	10519555	
8	Hopper 1.500-lit	10519807	







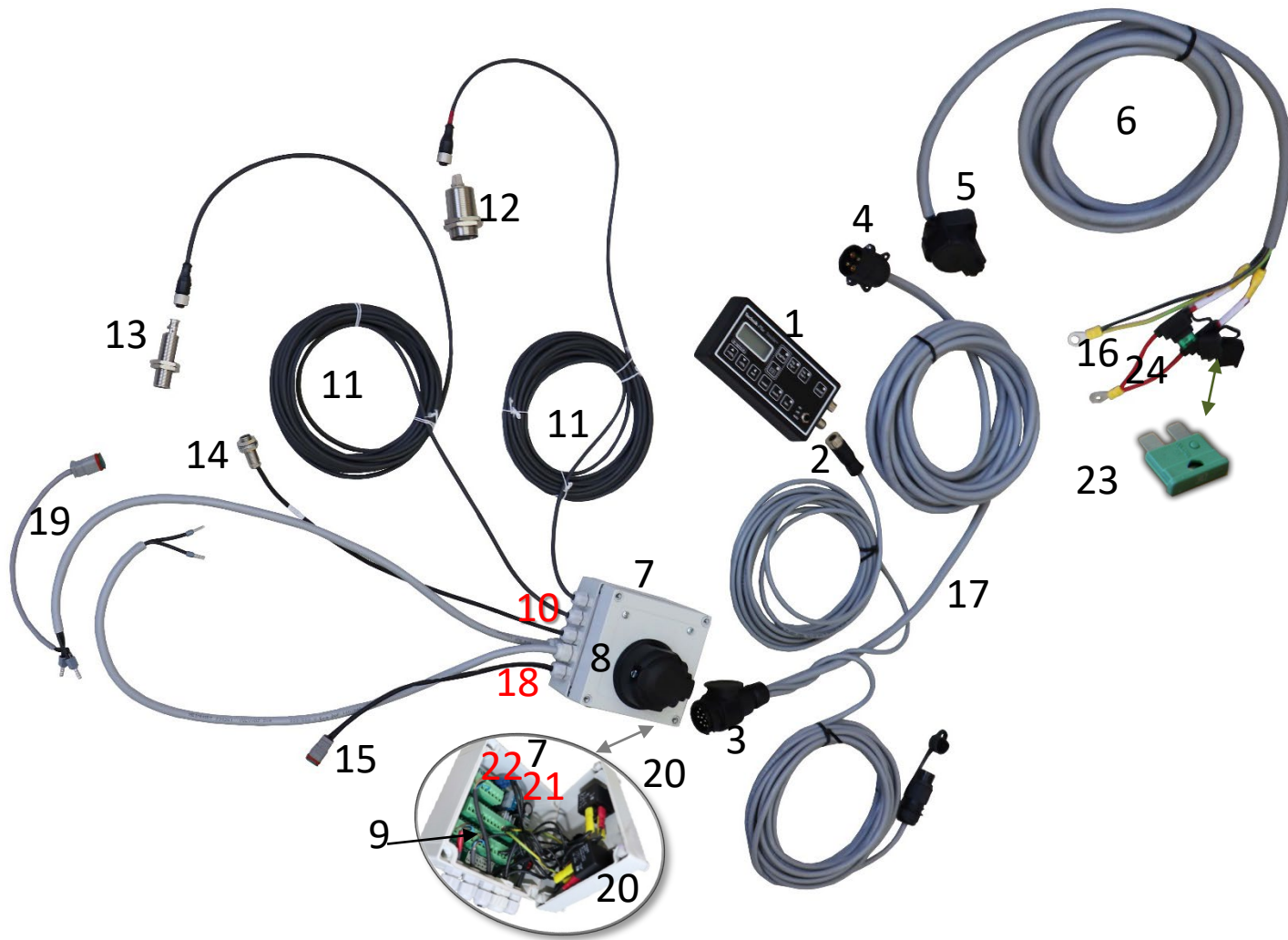

# SPARE PART LIST

## TURBO JET SUPER 8 SEEDER+ control unit

## ELECTRIC DRIVE 6.500 rpm

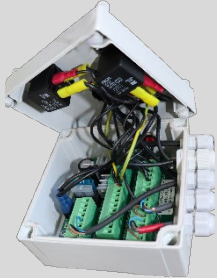

Nr	Product name	Spare part no	picture
1	Monitor SEEDER+	10589956	
2	Socket	10519811	

Nr	Product name	Spare part no	picture
03	Plug 13-pin	10519697	
04	Plug 4-pin	10519958	
05	Socket 4-pin	10519959	
06	Battery cable length: 3,5m	10617658	
07	Box with PCB	10589953	
08	Socket 13-pin	10519698	
09	PCB	10549779	
10	Cable screw	10519844	

Nr	Product name	Spare part no	picture
11	Sensor cable length: 10 m	10549906	
12	Sensor DM: 30mm	10639902	
13	Sensor DM: 18mm	10639901	
14	Sensor with cable	10619936	
15	Cable with plug	10549815	
16	Fuse with 6mm <sup>2</sup> cable	10539991	
17	Cable kit for Seeder (electric fan 6500rpm)	10619792	
18	Cable screw	10519963	

Nr	Product name	Spare part no	picture
19	Cable length: 0,8m	10549777	
20	Relais	10599934	
21	Fuse 2A	10539670	
22	Fuse 15A	10539863	
23	Fuse 30A	10539992	
24	Fuse with 2,5 mm cable	10539738	



