

OPERATOR'S MANUAL



DG600



ENG All rights reserved. The reproduction of this manual, either totally or partially, in any form whatsoever, whether on paper or through computer processes, is strictly prohibited.
dinamica generale S.p.A and the team involved in the preparation of this manual will not be held responsible for any problem arisen as a result of improper use of this manual, as they guarantee that the information contained in it has been subjected to careful inspection. The products are continuously checked and improved. For this reason dinamica generale S.p.A reserves the right to modify the information contained in this manual without prior notice.

dinamica generale Team

ITA Tutti i diritti riservati. La riproduzione di questo manuale, totale o parziale, in qualsiasi forma, sia su supporto cartaceo o elettronico, è severamente proibito.
dinamica generale S.p.A. e il team coinvolti nella preparazione di questo manuale non possono essere ritenuti responsabili per qualsiasi problema sorto a causa di uso improprio di questo manuale, pur garantendo che le informazioni in esso contenute sono state sottoposte ad un'attenta ispezione. I prodotti sono continuamente controllati e migliorati, per questo motivo dinamica generale S.p.A si riserva il diritto di modificare le informazioni contenute in questo manuale senza preavviso.

dinamica generale Team

FRA Tous droits réservés. La reproduction de ce manuel, totale ou partielle, sous toute forme, sur papier ou électroniquement est strictement interdite.
dinamica generale S.p.A et l'équipe impliquée dans la préparation de ce manuel ne sera pas jugé responsable d'aucun problème nait en raison de l'utilisation inexacte de ce manuel, en tant qu'eux garantissent que les informations contenues ont été soumises à soigneux inspection. Les produits sont vérifiés et améliorés sans interruption. Pour cette raison dinamica generale S.p.A se réserve le droite de modifier l'information contenue en ce manuel sans préavis.

dinamica generale Team

DEU Alle Rechte sind reserviert. Die Wiedergabe dieser Gebrauchsanweisung ist entweder vollständig oder nur ein Teil, in irgendeiner Form, (auf Papier oder elektronisch) streng verboten.
dinamica generale S.p.A und die Leute, die beschäftigt mit der Produktion dieser Gebrauchsanweisung waren, werden dafür nicht verantwortlich gehalten für irgendwelche Probleme, die als ein Ergebnis von falscher Verwendung dieser Gebrauchsanweisung entstehen könnten, da sie garantieren, daß die darin enthaltenen Informationen vorsichtig kontrolliert wurden. Die Produkte sind ununterbrochen überprüft und verbessert. Aus diesem Grund hält dinamica generale S.p.A sich das Recht vor, die in dieser Gebrauchsanweisung enthaltenen Informationen ohne vorausgehende Benachrichtigung zu modifizieren.

dinamica generale Team

ESP Todos los derechos reservados. La reproducción de este manual, en todo o en parte, en cualquier forma, ya sea en papel o electrónica, está estrictamente prohibido.
dinamica generale S.p.A y el equipo involucrado en la preparación de este manual no puede ser considerado responsable de los problemas que surgieron a causa del uso indebido de este manual, mientras que garantizar que la información contenida en él fueron sometidos a una inspección cuidadosa. Los productos son objeto de control permanente y mejorado, que es la razón por dinamica generale S.p.A reserva el derecho a modificar la información contenida en este manual sin previo aviso.

dinamica generale Team

RUS Все права защищены. Воспроизведение данного руководства, полностью или частично, в какой бы то ни было форме, на бумаге или через электронные источники, строго запрещено. dinamica generale S.p.A. и её коллектив, вовлеченные в разработку данного руководства, не несут ответственности за возникшие проблемы в результате ненадлежащего использования данного руководства, так как они гарантируют, что информация, содержащаяся в руководстве, подверглась тщательной проверке. Любые предложения по улучшению руководства будут восприняты с благодарностью. Продукты постоянно тестируются и совершенствуются.
Поэтому dinamica generale S.p.A. сохраняет за собой право изменять, содержащуюся в данном руководстве информацию, без предварительного уведомления.

Коллектив dinamica generale

CHS 所有权利保留。本手册中，完全或部分以任何形式，无论是在纸上或通过计算机处理，严禁转载。dinamica generale S.p.A. 不会举行和参与编写本手册的团队作为本手册的使用不当而产生的任何问题负责，因为他们保证其所载的资料一直受到仔细检查。然而，任何关于可能改进的建议，将不胜感激。产品不断检查和完善。出于这个原因 dinamica generale S.p.A. 储备 有权修改本手册，恕不另行通知所载资料。

dinamica generale 团队

INDEX

INDEX	1
TECHNICAL DATA	3
DIMENSIONS	4
CONFIGURATION	4
KEYBOARD	5
CONNECTION SCHEME	7
UNIVERSAL BOX	7
SLIM BOX	11
SETTING OF THE PARAMETERS	16
HOW TO ENTER INTO THE PASSWORD CONFIGURATION MENU	16
HOW TO EXIT THE PASSWORD CONFIGURATION MENU	18
LIST OF PASSWORDS THAT CAN BE SELECTED	19
PASSWORD 12: HOW TO SET THE CALIBRATION VALUE	20
PASSWORD 19: SEQUENCE OF THE SETTINGS = SETTINGS MENU	21
PASSWORD 45: HOW TO SET THE CALIBRATION WITH A REFERENCE WEIGHT	26
PASSWORD 46 : INVERSE CALIBRATION WITH SAMPLE WEIGHT	28
PASSWORD 67: HOW TO MODIFY IN PERCENTAGE THE WEIGHT	30
PASSWORD 99: HOW TO SET THE MAXIMUM WEIGHT	33
PASSWORD 155: SETTING OF THE DEFAULT VALUE	35
PASSWORD 258: ACTIVATION OF THE TOTAL MIXER ON THE UNLOADING PHASE	36
PASSWORD 333: HOW TO SET THE COMPONENT ACCUMULATION MODE	37
PASSWORD 444: HOW TO SET THE FUNCTIONING MODE	38
PASSWORD 454: HOW TO SET THE UNIT OF MEASURE	41
PASSWORD 456: HOW TO ENABLE THE VARIATION OF THE COMPONENT NAME/ UNLOADING POINTS	43
PASSWORD 500: HOW TO SET THE END OF THE LOAD EXECUTION MODE	44
PASSWORD 600: HOW TO SET THE WEIGHT REPEATER FUNCTION	45
PASSWORD 603: HOW TO ENABLE THE XL DISPLAY / EXTRA DISPLAY	46
PASSWORD 789: CLEARING OF ALL RECIPES AND UNLOADING PROGRAMS	48
PASSWORD 790: CLEARING OF ALL COMPONENTS AND UNLOADING POINTS	49
PASSWORD 791: LOADING OF THE NAMES FOR DEFAULT COMPONENTS AND UNLOADING POINTS	50
PASSWORD 800: CLEARING OF HISTORY	51
PASSWORD 880: HOW TO BLOCK THE WEIGHING	53
PASSWORD 888: SETTING ARCHIVES AND INHIBIT PROGRAM	54
PASSWORD 1357: FORMATTING CARD	55
PASSWORD 9372: SETTING OF VISUALIZATION ON THE DISPLAY	57
SETTING OF THE CUSTOMERS "ID"	59
MANUAL USE OF THE INDICATOR	60
PARTIAL/TOTAL FUNCTION MODE	61
NET / GROSS MODE	62
TRANSFER DATA VIA USB Key (available only in some versions)	65

SUPPLEMENTARY FUNCTIONS	71
PROGRAM MANAGEMENT	73
HOW TO ENTER IN THE MAIN MENU TO MODIFY EACH SETTINGS	73
EDITING MENU	73
HOW TO PROGRAM THE COMPONENTS	73
HOW TO PROGRAM THE RECIPES	75
HOW TO SET THE ANIMALS NUMBER	80
HOW TO PROGRAM THE UNLOADING POINTS	83
HOW TO PROGRAM THE UNLOADING PROGRAMS	84
EXECUTIONS MENU	89
HOW TO CARRY OUT THE EXECUTION OF THE RECIPES	89
HOW TO CARRY OUT THE EXECUTION OF THE UNLOADING PROGRAM	93
SETTINGS MENU	97
PARAMETERS SUBMENU	97
CONTRAST SUBMENU	97
ACCUMULATION MENU	98
COMPONENT ACCUMULATION	98
UNLOADING POINTS ACCUMULATION	98
CLEAR COMPONENT ACCUMULATION	99
CLEAR UNLOADING POINTS ACCUMULATION	99
SERVICE MENU	100
DIAGNOSTIC SUBMENU	100
NUMBER WORKING HOURS	100
SYMBOLS	101
OPTIONAL ACCESSORIES	102
PRINTER	102
WiNET™ MODEM	102
CAB DISPLAY	102
WEIGHT REPEATER	102
XL DISPLAY	103
EXTRA DISPLAY	103
Dina TEL 3	103
DTM™	104
EASY CONTROL 2	104
WEIGHT TRANSMITTER 2	104
CAN BUS Connector	105
Activation of communication protocol J1939	105
SEARCHING FOR FAULTS	106
CHECK THE DAMAGED COMPONENTS	108
ERROR CODES	113
DECLARATION OF CONFORMITY	115
WARNINGS	116
GUARANTEE	117

TECHNICAL DATA

Range (f.s.):	0 – 999.999
Resolution:	1 - 2 - 5 - 10 - 20 - 50
Accuracy:	< +/- 0,015 % f.s.
Operating temperature:	-30 / +65 °C (-22 / +150 °F) (-45 °C / -49°F on request)
Power supply:	9,5 – 32 Vdc ("LOW BATTERY" alarm < 9,5 Vdc)
Dimensions:	UNIVERSAL BOX: 233 x 230 x 112 mm (9.2 x 9.0 x 4.4 inches) SLIM BOX: 220 x 190 x 80 mm (8.6 x 7.5 x 3.1 inches)
Weight:	UNIVERSAL BOX: 2500gr (5.5 lbs) SLIM BOX: 1900 gr (4.2 lbs)
Case:	Specific Nylon with Glass Fiber V0
Protection grade:	IP 68 *
LCD Display / Height:	6 digits (16 segments) / 45 mm (1.77 inches) **
Display view:	15 m and more (50 ft)

* Complete protection from dust and water sprinklings, guaranteed in 1 meter full immersion with connectors closed by caps or with cables and/or accessories connected.

** Perfect visibility in any weather condition (Sunny, Cloudy, and Rainy)

DIMENSIONS

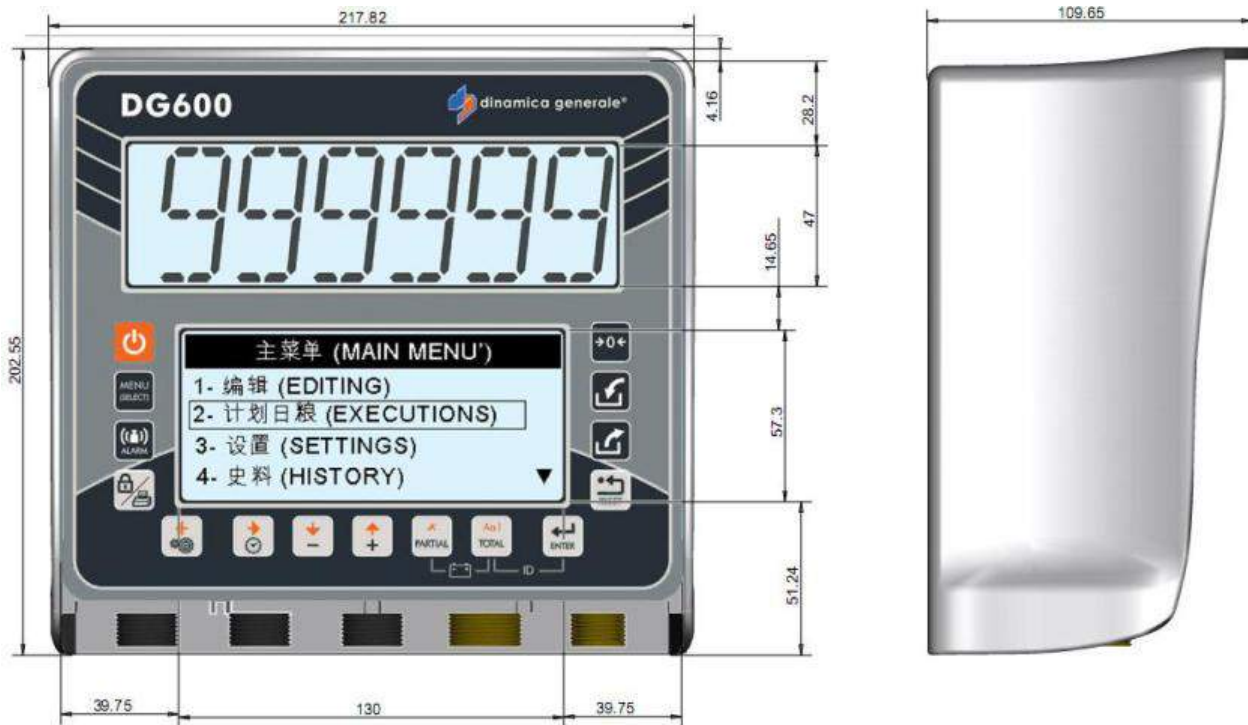



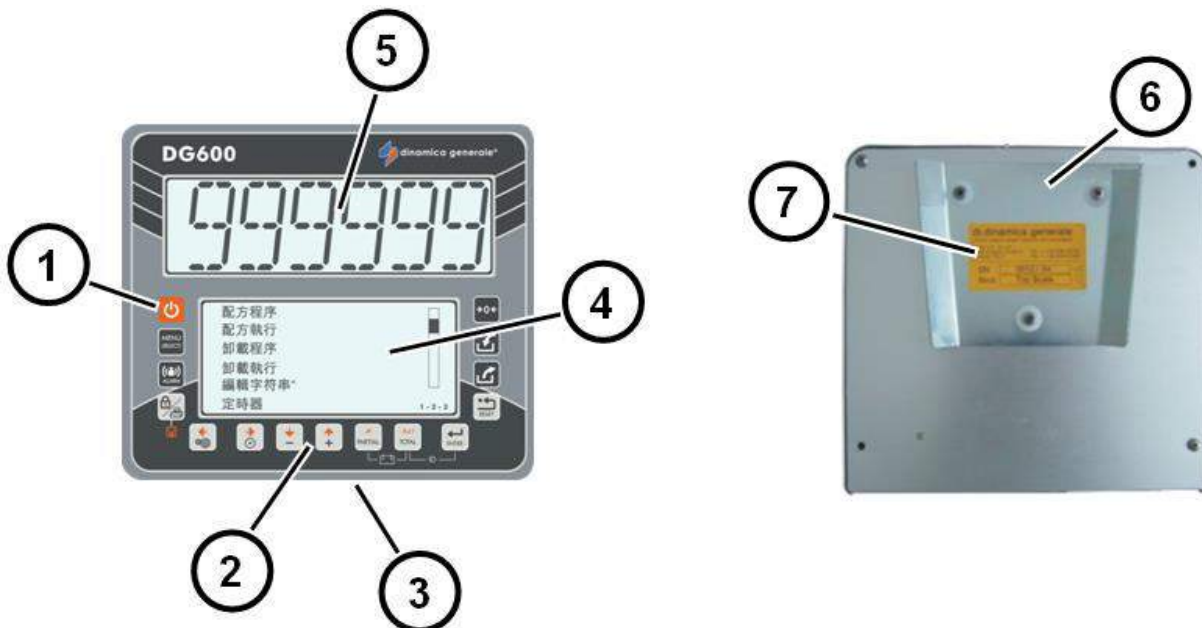











CONFIGURATION







1. ON/OFF key.
2. Function and setting keys.
3. Power, sensor and accessories connectors.
4. Graphic Lower Display: number of digit variable in function of characters visualized on 5 rows.
5. Upper Display: 6 digit LCD 45 mm to show the weight
6. Back panel.
7. Identification label.

KEYBOARD

	ON – OFF	Press this key in order to switching on / off the indicator
	MENU (SELECT)	Press this key in order to enter into the main menu that contains the submenu: EDITING, EXECUTIONS, SETTINGS, ACCUMULATION, SERVICE
	ALARM	From the TOTAL WEIGHT mode, press this key in order to set the weight. When this value has been reached, the alarm will start
	BLOCK / PRINT / SAVE	<ol style="list-style-type: none"> 1- During the manual function, press this key in order to print the actual weight value with date and time 2- The RECIPE and UNLOADING PROGRAMS that are memorized on the weighing system can be printed through this key at the end of each program or for a simple visualization of the program that was memorized 3- From the “Block Status” is possible to esc ONLY by pressing this key 4- During the Unloading Program execution it is possible to suspend the weighing by pushing this key and resume afterwards by pushing the same key 5- During the EDITING phase, press this key in order to save the name of component/recipe/unloading point/unloading program.
	SETTINGS / LEFT	<ol style="list-style-type: none"> 1- During the switching on, when the message “Please Wait” appears, press this key in order to enter in the password configuration 2- In TOTAL WEIGHT mode, press this key in order to enter in the SETTING MENU 3- During the EDITING phase, press this key in order to move to the left
	HOUR / RIGHT	<ol style="list-style-type: none"> 1- During the switching on, when the message “Please Wait” appears, press this key in order to setting the hour and the date 2- In TOTAL WEIGHT mode, press this key in order to display the hour and the date 3- During the EDITING phase, press this key in order to move to the right
	MINUS / DOWN	<ol style="list-style-type: none"> 1- In the MAIN MENU, press this key in order to scroll the voices of submenu 2- During the setting of the weight, press this key in order to decrease the value 3- During the EDITING phase, press this key in order to move down
	PLUS / UP	<ol style="list-style-type: none"> 1- In the MAIN MENU, press this key in order to scroll the voices of submenu 2- During the setting of the weight, press this key in order to increase the value 3- During the EDITING phase, press this key in order to move up

	PARTIAL/ DELETE	<p>1- In the PARTIAL FUNCTION MODE, press this key in order to zeroed the weight that is visualized on the display</p> <p>2- In the NET/GROSS MODE, press this key in order to memorize a tare</p> <p>3- In the password 444, this key is used to memorize a tare, it zeroes the display and memorizes the weight loaded until that moment, considering it as a tare</p> <p>4- During the EDITING phase, press this key in order to delete a character</p> <p>5- In the EDITING of the RECIPE, press this key in order to delete the component</p>
	TOTAL / SET CHARACTER	<p>1- Press this key in order to recall in any moment the TOTAL WEIGHT value</p> <p>2- In the password 444, this key is used to visualize alternately on the display the net and gross weight that is the result of the net weight minus the tare previously memorized</p> <p>3- During the EDITING phase, press this key in order to change the type of character (capital letter, lower case letter, number or sign)</p>
	ENTER	Press this key in order to confirm
	ZERO	Press this key in order to zeroed (TARE) the system
	RECIPES LIST	In TOTAL WEIGHT mode, press this key in order to enter quickly in the execution of the recipes
	UNLOADING PROGRAM LIST	In TOTAL WEIGHT mode, press this key in order to enter quickly in the execution of the unloading programs
	RESET	Press once to exit any menu

SPECIAL FUNCTIONS

	PARTIAL and TOTAL	Press simultaneously in order to display the battery voltage
	TOTAL and ENTER	Press simultaneously in order to enter in the setting of the customers ID
	BLOCK and PLUS	Press simultaneously in order to increase the value by 100
	BLOCK and MINUS	Press simultaneously in order to decrease the value by 100

CONNECTION SCHEME

UNIVERSAL BOX

Power and sensor connection (system with junction box)

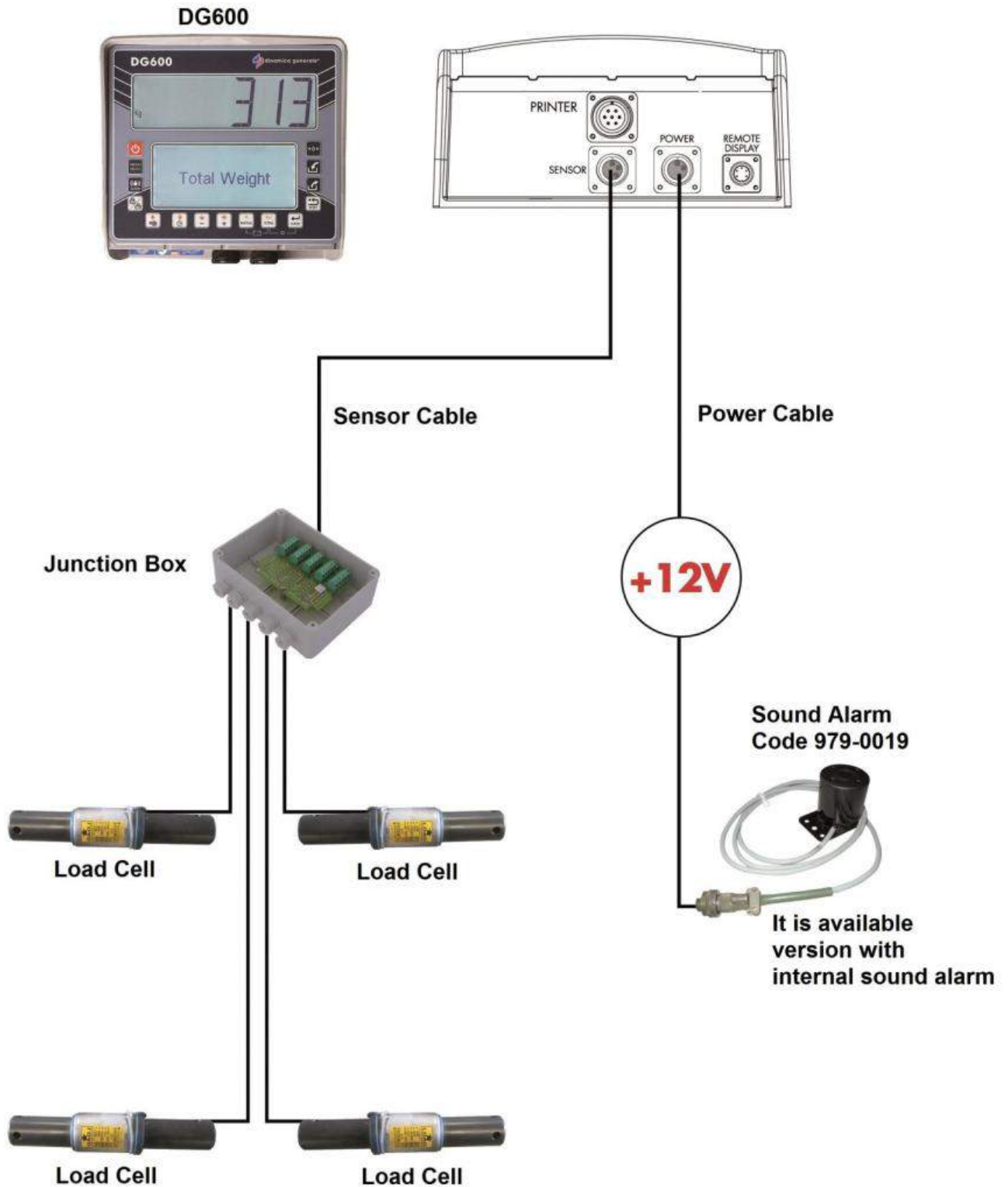

If the load cells are not all connected to the indicator, it's necessary to close the connectors not used with the special cap.

ENGLISH

Power and sensor connection (system without junction box)

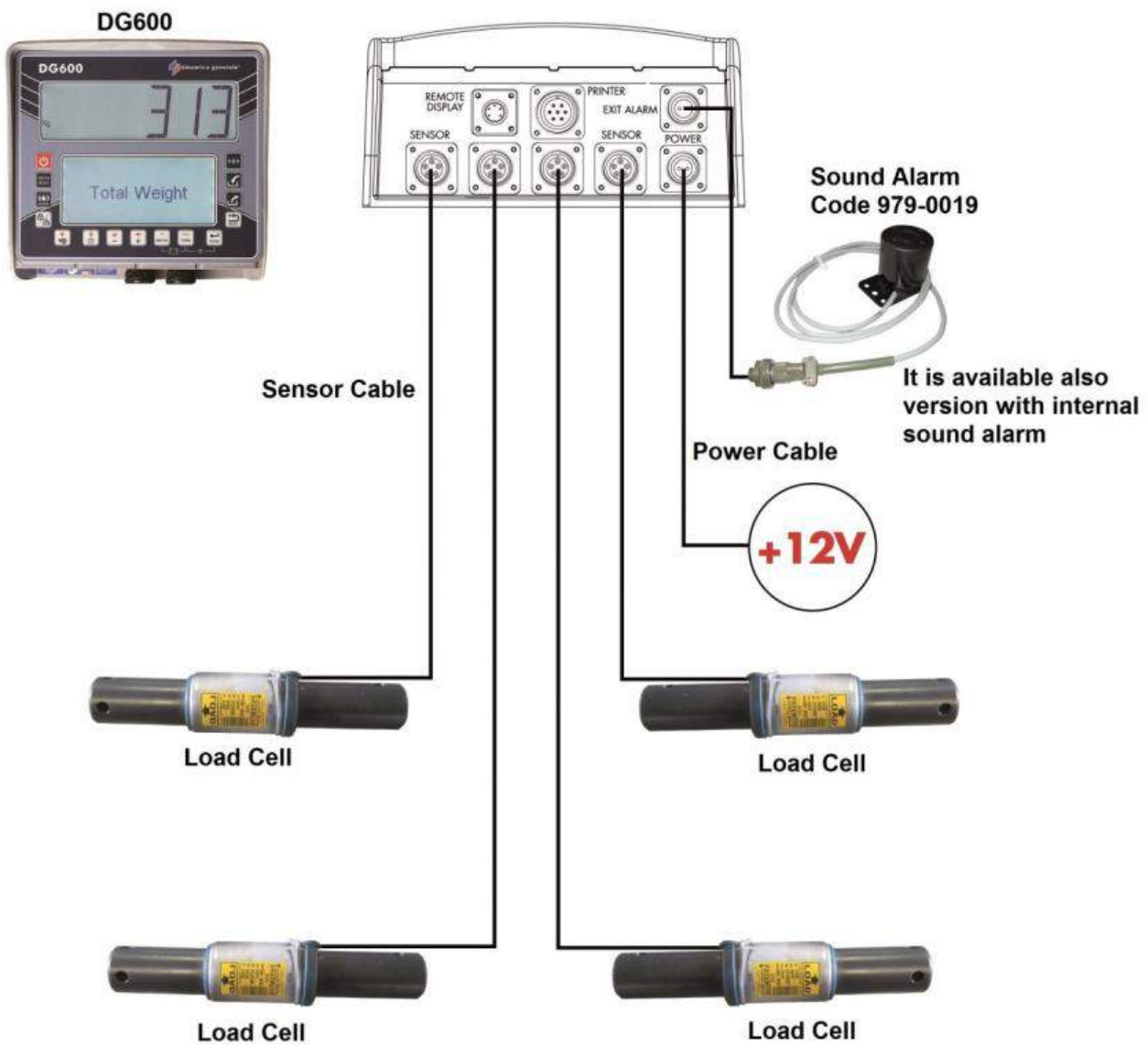

Accessories connection (system with 1 sensor connector)

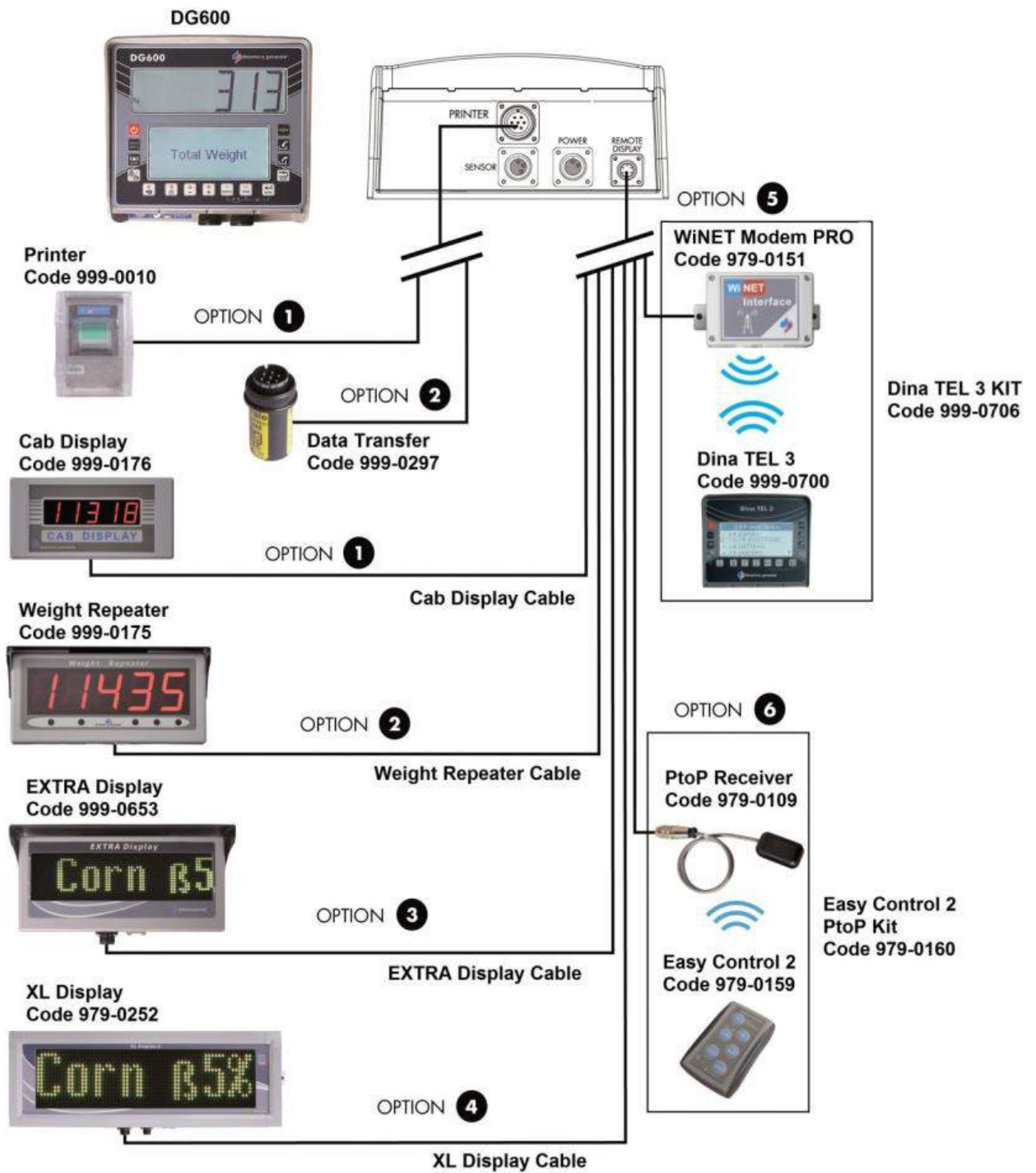

ENGLISH

Accessories connection (system with 4 sensor connectors)

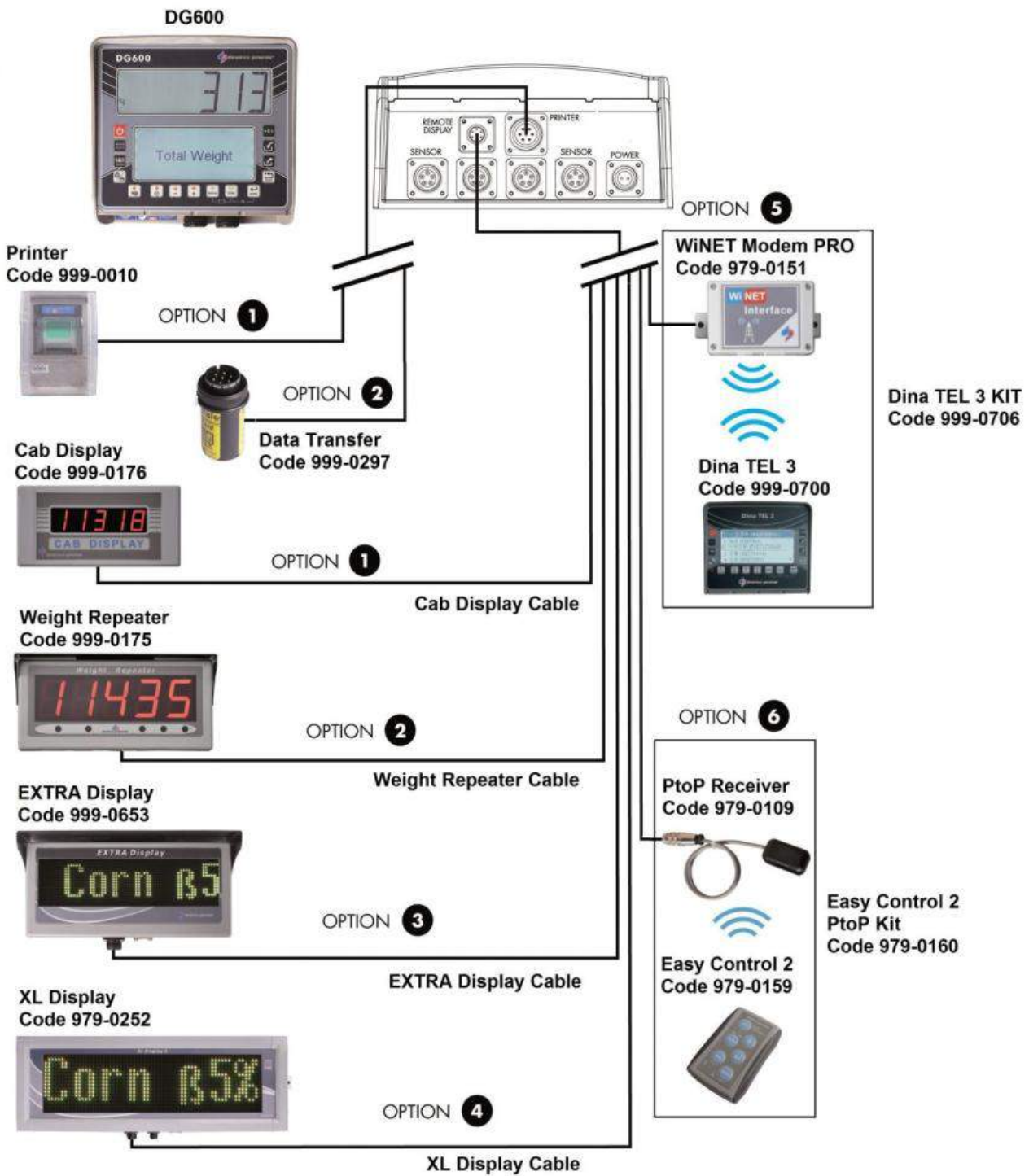

SLIM BOX

Power and sensor connection (system with junction box)

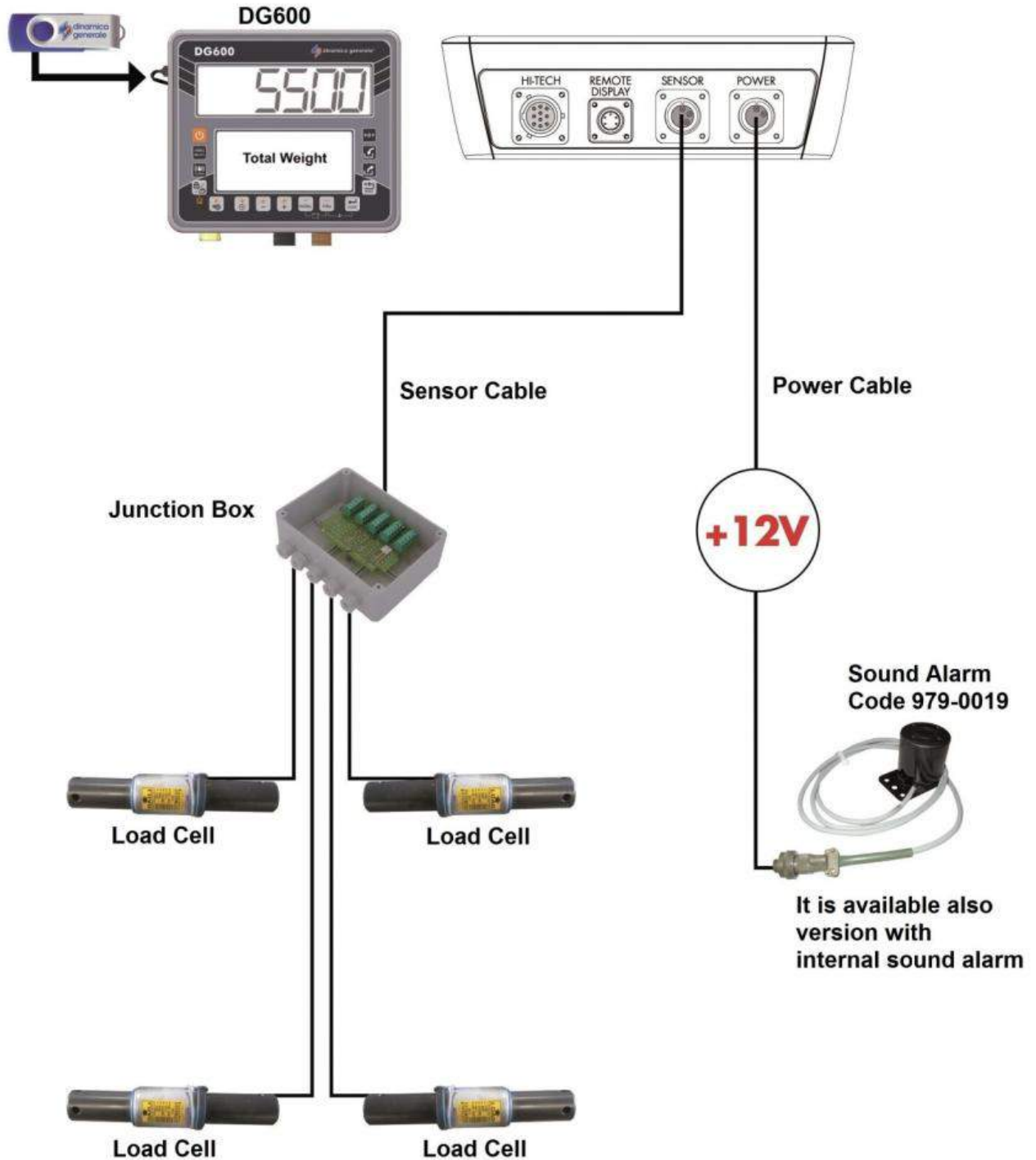

ENGLISH



If the load cells are not all connected to the indicator, it's necessary to close the connectors not used with the special cap.

Accessories connection (system with connection box 2 accessories Hi-Tech)

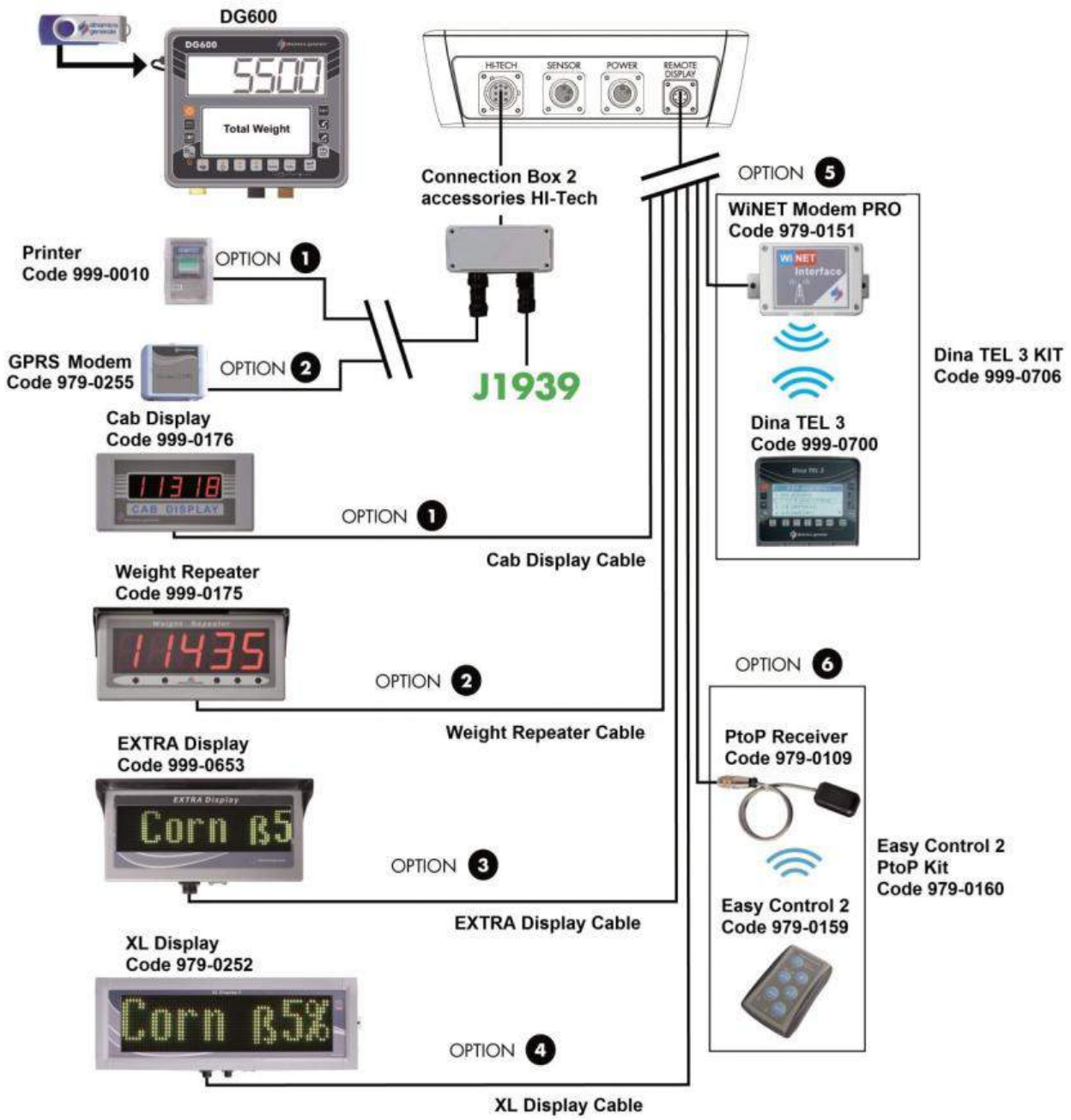

Accessories connection (system without connection box 2 accessories Hi-Tech)

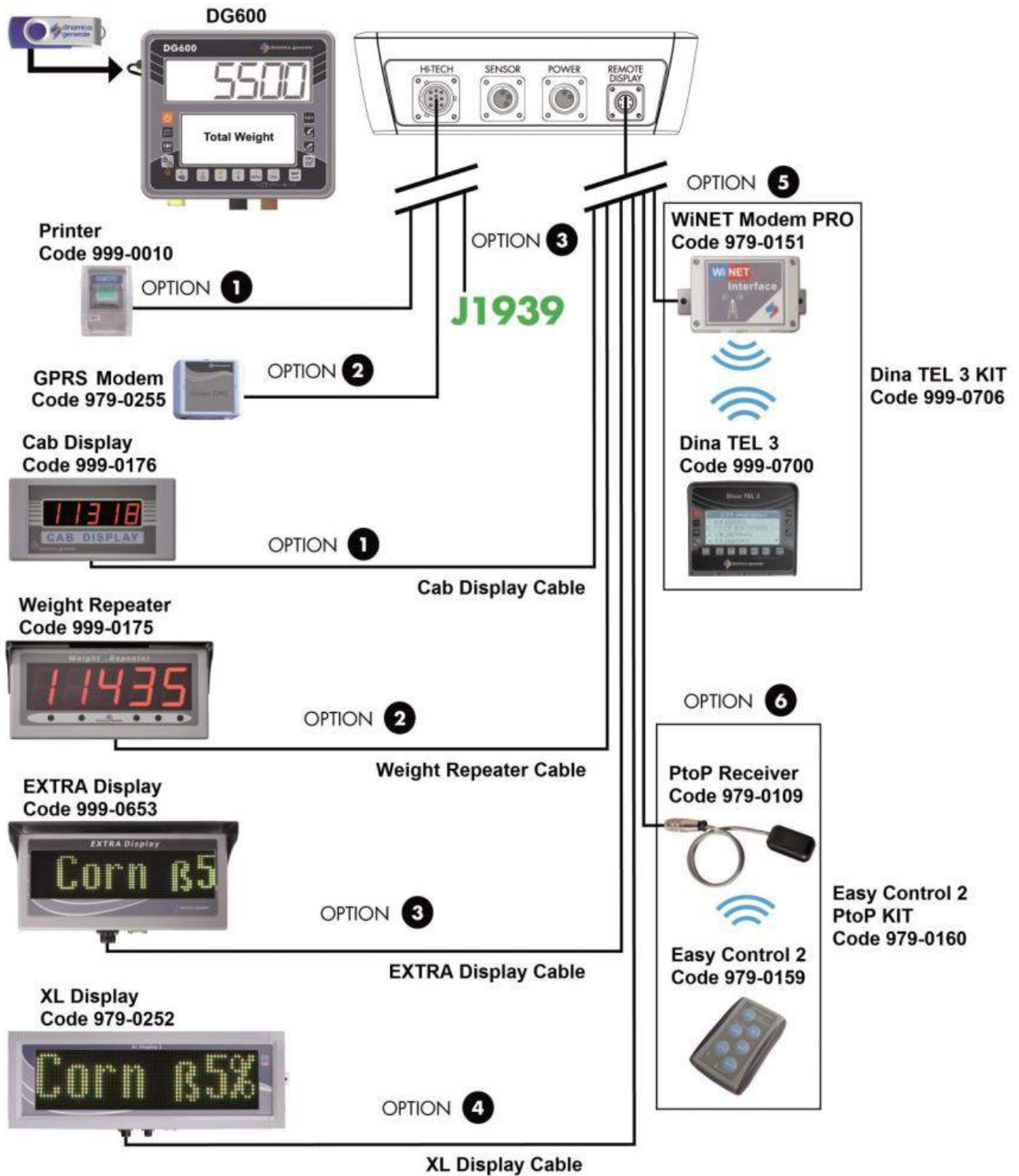

ENGLISH

Display connection (available for UNIVERSAL BOX and for SLIM BOX)

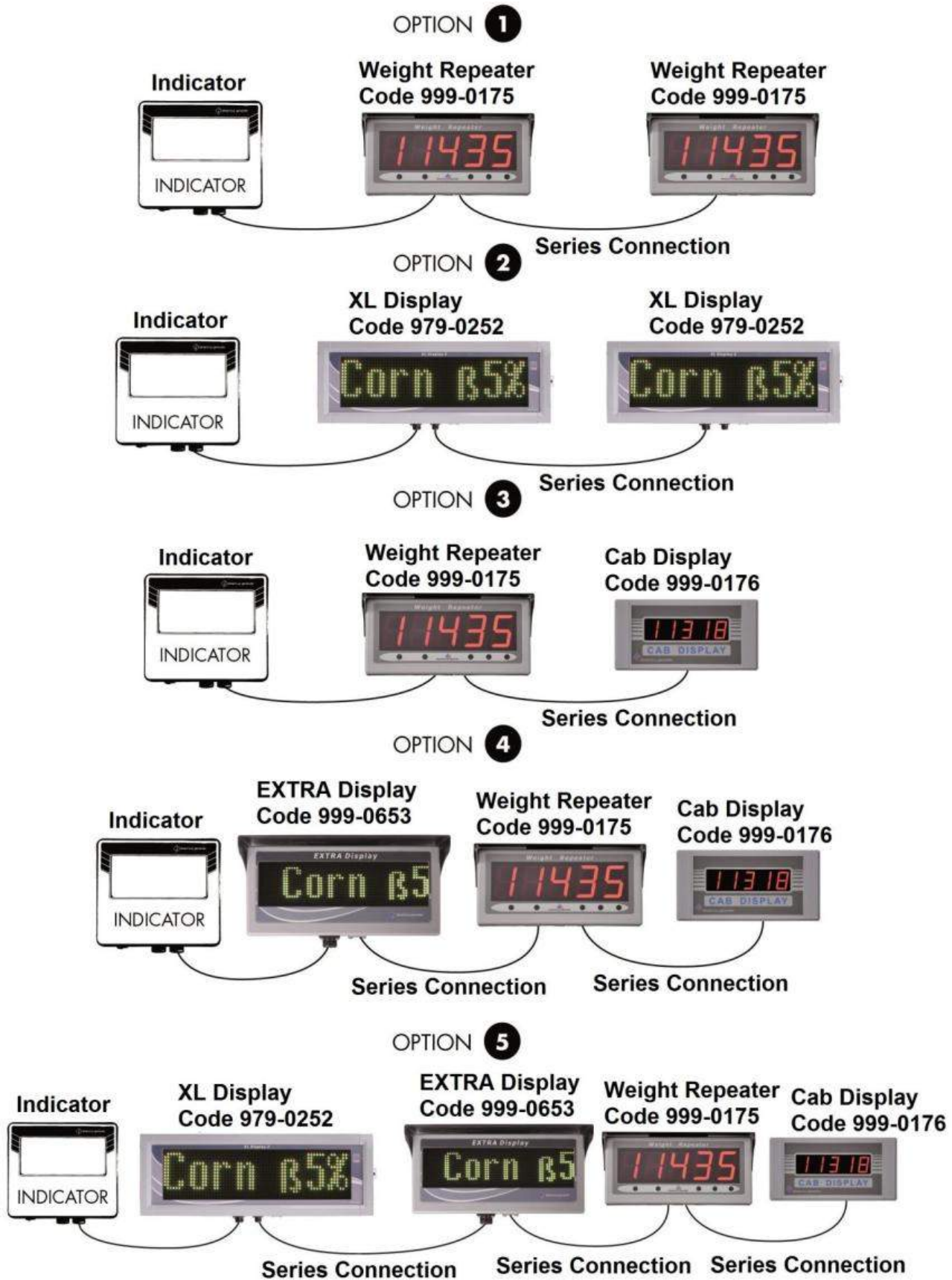

SETTING OF THE PARAMETERS

HOW TO ENTER INTO THE PASSWORD CONFIGURATION MENU

1 Turn on by pushing



2 Once the software revision has come up on the lower display the message "PLEASE WAIT"... will appear.



3 Press the setting key in order to enter in the password configuration.



4 The first message "Config." will appear on the lower display;



And afterwards

“Set password -/+”.

* Note 1



5



Release the key.

6



It is possible increase or decrease the value by 100 units through the pressing at the same time of the following keys:

- a) BLOCK/PRINT and PLUS in order to increase by 100 units;
- b) BLOCK/PRINT and MINUS in order to decrease by 100 units.

* NOTE 1

7



If the message “Set password -/+” does not appear and the indicator returns in TOTAL WEIGHT it means that the



key have not been pushed correctly.



8 To return to the Set password -/+ mode turn off the indicator and return to point 1.



HOW TO EXIT THE PASSWORD CONFIGURATION MENU

There are two ways to exit the password configuration menu:



1 Push the RESET key



After the “PLEASE WAIT” message the indicator returns in the **TOTAL WEIGHT** mode and the weight will be seen on the display.



2 Set the password ZERO with the PLUS and MINUS keys.



Push the ENTER key.



After the message “PLEASE WAIT” the indicator returns in the TOTAL WEIGHT mode and the weight will be seen on the display.



LIST OF PASSWORDS THAT CAN BE SELECTED

- 12** Calibration
- 19** Sequence of the settings = SETTINGS MENU
- 45** Calibration with a reference weight
- 46** Inverse Calibration with sample weight
- 67** Modification of the weight in % (fine calibration)
- 99** Setting of the maximum weight (over-range)
- 155** Setting of the default value
- 258** Activation of the Total Mixer on the unloading phase
- 333** Component accumulation
- 444** How to set the functioning mode
- 454** Setting of kg / pounds
- 456** Enable the modification of the Component/Unloading Points name
- 500** End execution load mode
- 600** Functioning of the weight repeater
- 603** How to enable the XL display / EXTRA display
- 789** Clearing of all recipes and unloading programs
- 790** Clearing of all components and unloading points
- 791** Loading of the names for default components and unloading points
- 800** Clearing of History
- 880** How to block the weighing
- 888** Setting Archives and Inhibit Program
- 1357** Formatting CARD
- 9372** Setting of visualization on the display

PASSWORD 12: HOW TO SET THE CALIBRATION VALUE

(Range: 1÷15000; Default: 2780)



The value must be lower than what set in the 99 password. If there are problems in order to enter and save the calibration value, check the value set in the password 99.

- 1 From the modality Set password -/+, select number 12 with the PLUS and MINUS keys.



- 2 Confirm with the ENTER key.



- 3 With the PLUS and MINUS key change the value of this parameter if necessary.



The calibration value depends on the number and capacity of the load cells. Contact **dinamica generale®** for further details. If a complete system has been bought, the DG indicators are already calibrated.



- 4 Push the ENTER key to confirm the new calibration parameter.



- 5 The indicator will return to Set password -/+.



PASSWORD 19: SEQUENCE OF THE SETTINGS = SETTINGS MENU

- 1 It is possible enter into the SETTINGS MENU in this way:

- From the modality Set password -/+, select number 19 with the PLUS and MINUS keys.
- From the modality TOTAL



WEIGHT press key

- From the TOTAL WEIGHT press



the key and selecting the submenu CONFIGURATIONS - PARAMETERS.



- 2 Inside this menu you could set many values in this way:

- a) Press the ENTER key in order to select the parameter to modify.
- b) Modify the number of the parameter with the PLUS and MINUS keys.
- c) Confirm with ENTER key.





- d) Press the  key in order to save the parameter.
- e) Press the RESET key in order to return back without save.

3 RESOLUTION OF THE WEIGHT VISUALIZATION

(Default: 1)

Resolution of the weight visualization setting that is seen on the display.



The division can be set at 1, 2, 5, 10, 20 or 50 Kg.



4 PERCENTAGE ON THE ALARM INTERVANTION

(Range: 0-50; Default: 15)

Setting of the percentage value of the acoustic alarm the controls the weighing. The activation of the pre-alarm (intermittent acoustic alarm) corresponds to this value.



This phase is called PREALARM and the acoustic signal is intermittent. By setting 15, the intermittent alarm is activated when the value to be loaded/unloaded is minus 15%. For example when programming the loading/unloading at 100 and the percentage at 15 the value that is read is 85 and therefore the intermittent alarm will start.



Suggested value: 15.

5 ALARM DELAY TIME

(Range: 0-60; Default: 7)

Programming of time of the acoustic alarm at the end of a loading/unloading.

The number that is set corresponds to the alarm time, expressed in seconds, when the set value is reached.



The maximum programmable alarm time is 60 seconds.



6 SETTING OF THE FILTER FOR THE WEIGHT STABILIZATION

(Range: 0-8; Default: 4)

If the weight on the display is unstable, the parameter has to be increased; if, on the other hand, the weight is too stable (slow update) the visualization will be improved if this value is decreased.



Once the value is been changed and you press RESET key, the message "Restart..PRESS ON/OFF" appears in order to save the parameter.



7 WAY TO ADVANCE FROM ONE COMPONENT/UNLOADING POINT TO THE OTHER

(Default: Yes)

By setting "AUTO: Yes" the passage from one Component/Unloading Point to the other is automatic once the set value has been reached and once the alarm time has passed.

By setting "AUTO: No" the passage from one Component/Unloading Point to the other will have to be made manually by pushing the ENTER key.



8 LANGUAGE

(Default: English)

Language selection used for the visualization of the messages. List of the available languages:

- English
- Italian
- Spanish
- German
- French
- Russian
- Czech
- Polish
- Chinese



9 SET DEVICE ADDRESS

(Range: 1-255; Default: 3)

Identification code that allows the indicator to connect, by RF, only to those devices that have the same address without creating problems of interference with other devices that use different addresses.



10 SET MOTION

(Range: 0-999; Default: 250)

Alarm that indicates sudden weight changes that could cause damage to the system.



If this problem is presented, verify the installation, state of the system and calibration values.



* We advise not to change this parameter.

11 STABILIZATION TIME

(Default: 0)

With the PLUS and MINUS keys, you can set the seconds that you have at your disposition when you load a component during the execution of the recipe.



This function is normally used for those components that are loaded with the loader. When the mixer is loaded with a loader it is difficult to put in the right amount that is programmed on the indicator, usually the quantity is a little less.

A count down on the upper display advises the operator that he has N seconds for load the component on the mixer before the indicator is passing on to the next component. The weight will be saved after the **STABILIZATION TIME** in order to have the real weight.



12 READING OF THE RECIPES FROM THE MEMORY CARD

(Default: No)

With the PLUS and MINUS keys set "Data Trans: Yes" if you want the recipe to be read directly by the memory card and subsequently memorize the executions.

In this case:

- it is not possible modify the recipes or the components;
- it is possible connect a load program to an unload program.



If this parameter is set at "Yes", when the indicator is turned on without the Data Transfer connected the message "DT Ignored" will appear; push the ENTER key to continue.



With the PLUS and MINUS keys set “Data Trs: No” if you do not want to read the recipe directly from the Memory Card, but only save the executions on the internal memory of the indicator.



Once the value is been changed and you press RESET key, the message “Restart..PRESS ON/OFF” appears in order to save the parameter.



13 BUZZER ENABLE

(Yes-No; Default: Yes)

Activating the buzzer is possible to weigh without necessarily looking the indicator because it will sound an alarm for all the time of the countdown.



PASSWORD 45: HOW TO SET THE CALIBRATION WITH A REFERENCE WEIGHT

- 1 From the modality Set password -/+, select number 45 with the PLUS and MINUS keys.



- 2 Confirm with the ENTER key.



- 3 The message “Calibration“ will appear for 2 seconds, it means that the calibration is starting.



- 4 The message “C1 Calib Step 1“ will appear for 2 seconds, it means that the first step of calibration is starting.



- 5 The message “Set Zero“ will appear, in this situation empty completely the mixer and then confirm with the ENTER key.

- 6 The message “Please Wait“ will appear, the ZERO value will be saved.

- 7 The message “C1 Calib Step 2“ will appear for 2 seconds, it means that the second step of calibration is starting.



- 8 Load the weight on the mixer and insert the value of the reference weight placed in the mixer (in Kg or Pounds) with PLUS and MINUS keys,



then confirm with **ENTER** key.

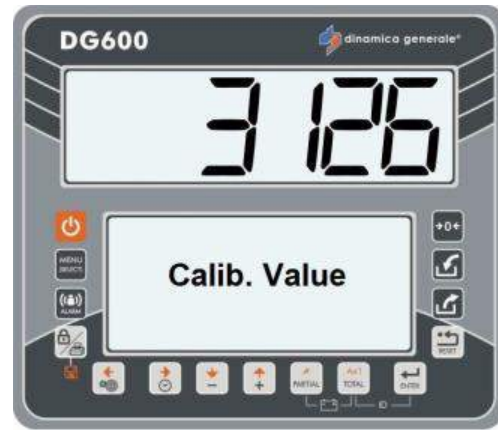

* The value is only indicative

- 9 The message "Please Wait" will appear, the NEW CALIBRATION value will be saved.

- 10 If the message "Setting Ok!" will appear, it means that the calibration procedure has been finished successfully.
If the message "E" will appear, it means that the calibration procedure has NOT been finished successfully; so retry the operation from the point 1.

- 11 After the end of the procedure the indicator returns to Set password +/-.

PASSWORD 46 : INVERSE CALIBRATION WITH SAMPLE WEIGHT

This procedure allows to carry out the calibration of the weighing system on the basis of a known weight that must be appropriately weighed on the medium in which the weighing system is mounted.

- 1 From the modality Set password +/-, select number 46 with the PLUS and MINUS keys.



- 2 Confirm with the ENTER key.



- 3 The message “Calibration” will appear for 2 seconds, it means that the calibration is starting.

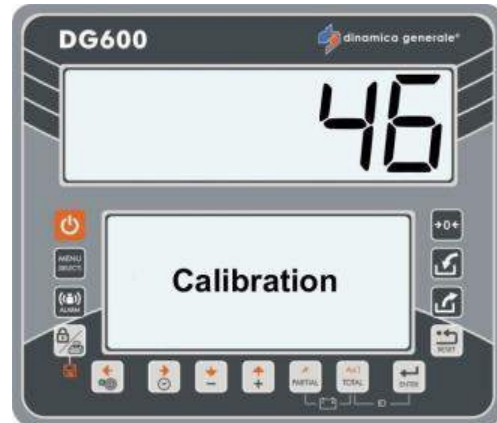

- 4 The message “C1 Calib Step 1” will appear for 2 seconds, it means that the first step of calibration is starting.



- 5 Load the weight on the mixer and insert the value of the reference weight placed in the mixer (in Kg or Pounds) with PLUS and MINUS keys,



then confirm with  key.

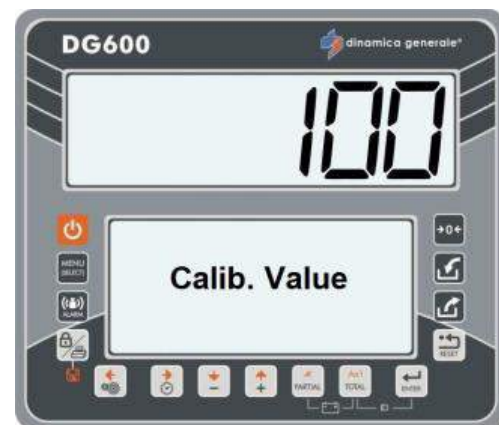

* The value is only indicative

- 6 The message “Please Wait” will appear, the NEW CALIBRATION value will be saved.

- 7 The message “C1 Calib Step 2” will appear for 2 seconds, it means that the second step of calibration is starting.



- 8 The message “Set Zero“ will appear, in this situation empty completely the mixer and then confirm with the ENTER key.

- 9 The message “Please Wait“ will appear, the ZERO value will be saved.

- 10 If the message “Setting Ok!” will appear, it means that the calibration procedure has been finished successfully.
If the message “E” will appear, it means that the calibration procedure has NOT been finished successfully; so retry the operation from the point 1.

- 11 After the end of the procedure the indicator returns to Set password -/+.

PASSWORD 67: HOW TO MODIFY IN PERCENTAGE THE WEIGHT

(Range: -10.0% / +10.0%; Default: 0.0)

- 1 From the modality Set password -/+ select the number 67, with the PLUS and MINUS keys.



- 2 Confirm with the ENTER key.



- 3 With the PLUS and MINUS keys select the percentage of the weight modification.
The interval that can be set is - 10,0% + 10,0%.



 minimum interval 0,1%.

- 4 Push ENTER key in order to confirm the value of the parameter.



- 5 After the message SETTING OK! appears the indicator returns to Set password -/+.



PASSWORD 99: HOW TO SET THE MAXIMUM WEIGHT

(Range: 100-999999; Default: 15000)



The value must be higher than what set in the 12 password.

- 1 From the modality Set password +/- select number 99 with the PLUS and MINUS keys.



- 2 Confirm with the ENTER key.



- 3 With the PLUS and MINUS keys change the value of this parameter if necessary, the range can be set at 100÷99999.



The value of this parameter is linked to the capacity of the machine, **dinamica generale®** suggests to set the maximum capacity of the machine.



- 4 Push the ENTER key in order to confirm the value of the parameter.



- 5 The indicator returns to Set password +/-.



PASSWORD 155: SETTING OF THE DEFAULT VALUE

- 1 From the modality Set password -/+ select number 155 with the PLUS and MINUS keys.



- 2 Confirm with the ENTER key.



- 3 The message "Set Default Val?" is shown.

Press the ENTER key if you wish restore the default values. In this case the message "Setting OK!" appears.

Press the RESET key if you wish exit without restore the values.



- 4 The indicator returns to Set password -/+.



PASSWORD 258:
ACTIVATION OF THE TOTAL MIXER ON THE UNLOADING PHASE

(Default: No)

- 1 From the modality Set password +/- select number 258 with the PLUS and MINUS keys.



- 2 Confirm with the ENTER key.



- 3 The message "Total mixer" is shown. Set the value with the PLUS and MINUS keys and confirm with the ENTER key:

- Yes: it automatically proposes, for a few seconds, the total on the mixer and automatically recalculates the partition of this total on the various unloading points (it allows the unloading of the real material inside of the mixer).
- No: It NOT allows the unloading of the real material inside of the mixer but the material that exceeds the value predetermined remains inside of the mixer.



Press the RESET key if you wish exit without save the datas.

- 4 The indicators returns to Set password +/-.



PASSWORD 333: **HOW TO SET THE COMPONENT ACCUMULATION MODE**

(Default: Yes)

This function is used to save in the memory of the indicator the information about the total loaded of the single component during the executions of all the recipes.

- 1 From the modality PASSWORD select the number 333 with the PLUS and MINUS keys.



- 2 Confirm with the ENTER key.



- 3 Enable and disable the COMPONENT ACCUMULATION mode



- a) To enable the COMPONENT ACCUMULATION mode, select with the PLUS and MINUS keys Accumulation: Yes and confirm by pushing ENTER.



- b) To disable the COMPONENT ACCUMULATION mode, select with the PLUS and MINUS keys Accumulation: No and confirm by pushing ENTER.



- 4 The indicator returns to Set password +/-.



PASSWORD 444:
HOW TO SET THE FUNCTIONING MODE

(Default: 1 - Partial/Total)

- 1 From the modality PASSWORD select the number 444 with the PLUS and MINUS keys.



- 2 Confirm with the ENTER key.



Selection of the PARTIAL/TOTAL or GROSS/NET mode with the PLUS and MINUS keys.



- 3** In order to always visualize the loaded weight in that precise moment, set the function PARTIAL/TOTAL by pressing the TOTAL key. With the PARTIAL key it is possible to carry out partial weighing by zeroing the display and verifying what is being loaded in that moment.



ENGLISH



Changing the mode from PARTIAL to TOTAL, the previous weight will be lost since each partial weighing will be added to the total sum.



In this configuration it is not possible to store one tare in order to see it again, since the system's tare and zero coincide. This function is indicated especially in the use of mixers or trailers in general.

ACTION	UPPER DISPLAY	LOWER DISPLAY	PARTIAL LOADED WEIGHT	TOTAL LOADED WEIGHT
	200	Total Weight	0	200
Push PARTIAL	0	Partial Weight	0	200
Load 100KG	100	Partial Weight	100	300
Push TOTAL	300	Total Weight	0	300
Push PARTIAL	0	Partial Weight	0	300
Load 500KG	500	Partial Weight	500	800
Push PARTIAL	0	Partial Weight	0	800
Load 200KG	200	Partial Weight	200	1000
Push TOTAL	1000	Total Weight	0	1000
Unload everything	0	Total Weight	0	0

By setting the function NET/GROSS, the PARTIAL key is used to memorize a tare, it zeroes the display and memorizes the weight loaded until that moment, considering it as a tare.

The TOTAL key is used to visualize alternately on the display the net and gross weight that is the result of the net weight minus the tare previously memorized.



In this function a tare value is obtained and is memorized therefore can be visualized until the system is newly zeroed. Such a function is indicated for fixed application with platforms in order to weigh fruit and vegetable crates/crates by verifying the net weight and gross weight and registering a tare without modifying the reference to the zero of the system.

ACTION	UPPER DISPLAY	LOWER DISPLAY	NET WEIGHT	GROSS WEIGHT	TARE
	200	GROSS Weight	0	200	200
Push PARTIAL	0	Set TARE	0	200	200
	100	NET Weight	0	200	200
Push TOTAL	200	GROSS Weight	0	200	200
Load 100KG	300	GROSS Weight	100	300	200
Push TOTAL	100	NET Weight	100	300	200
Load 500KG	600	NET Weight	600	800	200
Push TOTAL	800	GROSS Weight	600	800	200
Unload everything	200	GROSS Weight	0	200	200
Push TOTAL	0	NET Weight	0	200	200

4 Push ENTER key in order to confirm the value of the parameter. The indicator will return to Set password -/+.



PASSWORD 454: HOW TO SET THE UNIT OF MEASURE

(Default: Kg)

- 1 From the modality Set password +/- select the number 454 with the PLUS and MINUS keys.



ENGLISH

- 2 Confirm with the ENTER key.



- 3 Selection of the unit of measure in kg or pounds with the PLUS and MINUS keys. The same will be indicated on the tickets that come out of the printer near the weight value.



- a) By setting 0=Kg the weight will be visualized in Kilograms.



- b) By setting 1=Lb the weight will be visualized in Pounds.



One pound = 0,454 kg



- 4 Push ENTER key in order to confirm the value of the parameter. The indicator will return to Set password +/-.

PASSWORD 456: HOW TO ENABLE THE VARIATION OF THE COMPONENT NAME/ UNLOADING POINTS

(Default: Yes)

- 1 From the modality Set password -/+ select the number 456 with the PLUS and MINUS keys.



- 2 Confirm with the ENTER key.



- 3 Possibility to enable the variation of the Component name/Unloading Points directly on the indicator with the PLUS and MINUS keys.

- a) Select Yes to enable the Component/Unloading Points name variation.
- b) Select NO to disable the variation of the Component/ Unloading Points name from the indicator.



- 4 Push ENTER key in order to confirm and the indicator will return to Set password -/+.



PASSWORD 500: HOW TO SET THE END OF THE LOAD EXECUTION MODE

(Default: Total)

- 1 From the modality Set password +/- select the number 500 with the PLUS and MINUS keys.



- 2 Confirm with the ENTER key.



- 3 Press the PLUS and MINUS keys in order to modify the value (Total / Recipe / Menu).

Press ENTER key in order to confirm.



- 4 The indicator will immediately return to Set password +/-.



PASSWORD 600: HOW TO SET THE WEIGHT REPEATER FUNCTION

(Default: Menu)

- 1 From the modality Set password +/- select the number 600 with the PLUS and MINUS keys.



- 2 Confirm with the ENTER key.



- 3 Select the function of the weight repeater with the PLUS and MINUS keys.

- a) Select MENU in order to align the visualization of the weight repeater with the state of the indicator. The weight repeater will show the information that is visualized on the indicator's display.



Default value: Menu.



- b) Select TOTAL in order to ALWAYS set the visualization of the total weight on the weight repeater regardless of the state of the indicator.

- 4 Press the ENTER key in order to confirm the function mode and the indicator will automatically return to Set password +/-.



PASSWORD 603: HOW TO ENABLE THE XL DISPLAY / EXTRA DISPLAY

(Default: Normal)

- 1 From the modality Set password +/- select the number 603 with the PLUS and MINUS keys.



- 2 Confirm with the ENTER key.



- 3 Communication authorization between the indicator and the XL Display / EXTRA Display with the PLUS and MINUS keys.



- a) Select **ADVANCED** to enable the communication with the XL Display / EXTRA Display.



- b) Select **NORMAL** to disable the communication with the XL Display / EXTRA Display.



- c) **Select FULL** if there is another device connected to the XL Display / EXTRA Display (ex.: Weight Repeater, Motor Control,...) and you want to use both.



- 4 **Press ENTER** key in order to confirm the function mode and the indicator will automatically return to Set password -/+.



PASSWORD 789: CLEARING OF ALL RECIPES AND UNLOADING PROGRAMS

- 1 From the modality Set password -/+ select number 789 with the PLUS and MINUS keys.



- 2 Confirm with the ENTER key.



- 3 The message "Clear all recipes, u.prog.?" is shown.

Press the ENTER key if you wish cancel all the datas of recipes and unloading programs. In this case the message "Deleted" appears.

Press the RESET key if you wish exit without cancel the datas.



- 4 The indicator returns to Set password -/+.



PASSWORD 790: **CLEARING OF ALL COMPONENTS AND UNLOADING POINTS**

- 1 From the modality Set password -/+ select number 790 with the PLUS and MINUS keys.



- 2 Confirm with the ENTER key.



- 3 The message "Clear all comp. u.points?" is shown.

Press the ENTER key if you wish cancel all the datas of components and unloading points. In this case the message "Memory Deleted" appears.

Press the RESET key if you wish exit without cancel the datas.



- 4 The indicator returns to Set password -/+.



PASSWORD 791: LOADING OF THE NAMES FOR DEFAULT COMPONENTS AND UNLOADING POINTS

- 1 From the modality Set password -/+ select number 791 with the PLUS and MINUS keys.



- 2 Confirm with the ENTER key.



- 3 The message “Set default comp. u.points name?” is shown. Press the ENTER key if you wish loading the DEFAULT NAMES of components and unloading points:

- Component 1
- Component 2, etc.
- Unload. Point 1
- Unload. Point 2, etc.



Press the RESET key if you wish exit without to load the default names.

- 4 The indicator returns to Set password -/+.



PASSWORD 800: CLEARING OF HISTORY

- 1 From the modality Set password +/- select number 800 with the PLUS and MINUS keys.



- 2 Confirm with the ENTER key.



- 3 With the PLUS and MINUS keys, select the menus to zeroing:

- 1- N. Working Hours: it is possible zeroing the total hours that the indicator has worked;
- 2- N. Overload: it is possible zeroing the number of overloads that are been displayed.



- 4 Press the ENTER key if you wish cancel all the datas described at point 3. In this case the messages "Confirm deleting?" and then "Deleted" appears.



Press the RESET key if you wish exit without cancel the datas.

- 5 The indicator returns to Set password +/-.



PASSWORD 880: HOW TO BLOCK THE WEIGHING

(Default: DG)

- 1 From the modality Set password +/- select the number 880 with the PLUS and MINUS keys.



- 2 Confirm with the ENTER key.



- 3 Select the function of the BLOCK button with the PLUS and MINUS keys.



- a) Select DG in order to enable the BLOCK function during an execution or in Total Weight. From the "Block Status" is possible to esc by pressing the button:



in this case the indicator recalls the weight that was present at the time of the block regardless eventual changes happened during the "Block Status".



in this case the indicator will display the weight considering eventual changes happened during the "Block Status".

- b) Select M1 in order to enable the BLOCK function ONLY during an execution (and not in Total Weight).

From the "Block Status" is possible to esc ONLY



by pressing the button (in this case the indicator recalls the weight that was present at the time of the block regardless eventual changes happened during the "Block status").

When the indicator returns in Total Weight will display the weight considering eventual changes happened during the "Block Status".



PASSWORD 888: SETTING ARCHIVES AND INHIBIT PROGRAM

(Default: Man+Load, FALSE, 5)

- 1 From the modality Set password +/- select number 888 with the PLUS and MINUS keys in order to filter which executions that you wish save.



- 2 Confirm with the ENTER key.



- 3 The first parameter is shown: SET ARCHIVES. It is possible set one of those values in order to save the loading/unloading executions:

- Manual
- Load
- Man.+Load
- Unload
- Man.+Unload
- Load+Unload
- M.+Load+Unl



Press the RESET key if you wish exit without change the value.

- 4 To confirm and proceed on to the next parameter, press the ENTER key.



- 5 The second parameter is shown: INHIBIT PRG. It is possible enable or disable it:

- Yes: in order to inhibit the operator to execute the operations on the system to prevent loss of data;
- No: in order to deactivate the inhibit of the operator.

Press the RESET key if you wish exit without change the value.



- 6 To confirm and proceed on to the next parameter, press the ENTER key.



- 7 The third parameter is shown: SET WARNING EXECUTION.

This value corresponds to the number of execution that miss before the card is full. A message advises the operator that the card is almost full.

It is possible set the value with the PLUS and MINUS keys. Confirm it with the ENTER key.

Press the RESET key if you wish exit without change the value.



- 8 The indicator returns to Set password +/-.



PASSWORD 1357: FORMATTING CARD

- 1 From the modality Set password +/- select number 1357 with the PLUS and MINUS keys.



- 2 Confirm with the ENTER key.



- 3** If the card is plugged, the message “FORMAT CARD?” appears.

Press the ENTER key in order to delete all the datas inside of the card.

The message “Formatting..” appears and then “Card Formatted”.



- 4** Press the RESET key in order to return back without delete the datas. In this case, the message “DT Ignored” appears.



- 5** The indicator returns to Set password -/+.



PASSWORD 9372: SETTING OF VISUALIZATION ON THE DISPLAY

(Default: Percentual)

- 1 From the modality Set password +/- select number 9372 with the PLUS and MINUS keys.

It allows to decide if and in which mode visualize the name of the component on the Extra Display (Accessory that can be requested) and on the Upper display where normally it shows only the weight during the executions of recipe or unloading program.



- 2 Confirm with the ENTER key.



- 3 The message "Visual. mode" is shown. Change the value with the PLUS and MINUS key:

- None: NEVER, the name of the component (unloading point) is visualized only on the lower graphical display.



- Percentual: the name of the component is visualized alternatively with the weight to load since the value of the weight will be increased / decreased the % value as set in this password.

Set the % value with the PLUS and MINUS keys.

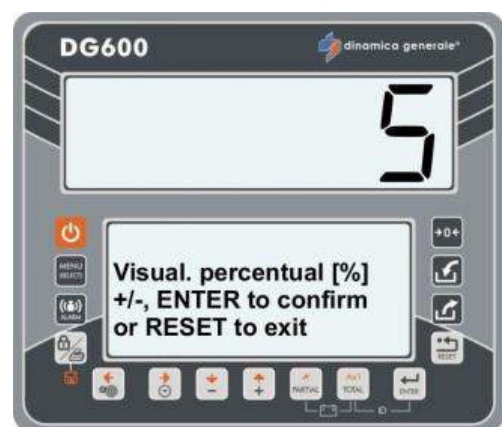

- **Time:** the name of the component is visualized alternatively with the weight to load until the seconds finish as set in this password.

Set the value of seconds with the PLUS and MINUS keys.



The characters will be displayed on the upper display only with standard code ASCII characters. Any special characters will be replaced with simple characters.

- 4 Press the ENTER key in order to confirm the value of the parameter.



- 5 The indicator returns to Set password +/-.



SETTING OF THE CUSTOMERS "ID"

With this function it is possible to associate a customer "ID" with a recipe before it is carried out.

- 1 Push simultaneously the TOTAL and ENTER keys.



- 2 Set the value of the customer ID with the PLUS and MINUS keys.

The customer "ID" can have the following values:

- a) 1÷65000, simple number if the Memory Card is not connected to the indicator.
- b) 1÷99 if the Memory Card is connected; the indicator shows the list programmed through the software DTM.



- 3 Confirm the Customer "ID" by pushing ENTER.



- 4 The message "Setting Ok!" appears on the lower display.



MANUAL USE OF THE INDICATOR

TURNING ON



a) After pushing the key, on the lower display you will see in sequence the messages “DG600”, the software revision number and “Please Wait”.



b) Afterwards a weight value will appear on the upper display and the indication TOTAL WEIGHT on the lower display.



 The use of the indicator is suggested 15 minutes after it has been turned on, especially if it is used with below zero °C temperatures.

* The weight value is indicative



The TOTAL WEIGHT value can be recalled in any moment by pressing the TOTAL key.



PARTIAL/TOTAL FUNCTION MODE

Selected by password 444

ZEROING



- a) Zero with the  key.
- b) The message:
 “Set Tare” will appear;
 keep pushing the ZERO key until the message:
 “Setting Ok !” is visualized.
- c) The indicator will return to the TOTAL WEIGHT mode.



* The weight value is indicative



The zeroing and the zero of the system are connected to the situation of the machine in the moment that it is carried out. Therefore the conditions of the terrain, temperature and mechanical solicitations are influent.

If the machine is moving on a slope or is subjected to different mechanical or temperature conditions, it is not necessary said that at equal loads you have the same visualization.

A visualization of 0 Kg carried out on a flat surface could be different that made on a slope.

PARTIAL WEIGHINGS

- a) By pushing the PARTIAL key the weight that is visualized on the display is zeroed (the value previously visualized will be memorized) therefore giving the possibility to load/unload the material by starting from a fixed reference.
- b) At the end of a load/upload another partial weighing can be carried out by restarting from point “a” or visualize the total weight by pushing the TOTAL key.



* The weight value is indicative

NET / GROSS MODE

Selected by password 444

ZEROING

a) Carry out the zeroing by pushing the



key

b) The message :

“Set Tare” will appear
keep pushing the ZERO key until the
message:
“Setting Ok !” is visualized.



c) The indicator will return to GROSS WEIGHT.

After the zeroing of the system the
net and gross weight will coincide
and are equal to zero.



* the weight value is indicative

NET/GROSS WEIGHT

- a) In this mode the **PARTIAL** key is used to memorize a tare. Push for 3 seconds and the following messages will appear:

PRESS FOR 3 SECOND

then

SETTING TARE OK

At this point the display will visualize a zero weight and the one previously seen will be added up to the gross weight.

With the **TOTAL** key the alternate visualization of the **NET WEIGHT** and **GROSS WEIGHT** will be seen.

The net weight is the gross weight minus the tare previously memorized.



LOADING WITH ALARM (Available in both the functioning modes.)

- a) From the **TOTAL WEIGHT** mode push



the **ALARM** key until the message **Set ALARM -/+** is visualized on the lower display.



- b) Set the weight with the **PLUS** and **MINUS** keys.



- c) Confirm the set weight by pushing the **PARTIAL** key and proceed with the load / unload phase. The weight will be visualized decreasingly on the display independently from the fact that you are loading or unloading.

When the programmed percentage (**SETTING MENU - PERCENTAGE ON THE ALARM INTERVANTION**) has been reached, the alarm will start in an intermittent way. At 100% the alarm will change from intermittent to continuous for the time set in the Setting Menu (**ALARM DELAY TIME**).

- d) At the end the indicator will pass automatically on **TOTAL** weight or **GROSS WEIGHT**.



UNLOADING WITH ALARM

Carry out the same procedure as **LOADING WITH ALARM**. The device automatically recognizes the unloading phase.



If a load / unload with alarm has already been set, and during a move the weight varies, it can be restored by pushing **PARTIAL**.

If the indicator is switched off with a set load/unload alarm, however, this value is suggested to the next process.



* The alarm value is only indicative.

TRANSFER DATA VIA USB Key (available only in some versions)



The USB port is available only in some part number. It allows to transfer data via USB Key.



It is possible to connect or disconnect the USB Key at any time, without restarting the indicator.

- 1 Connect the USB Key to the indicator and, from TOTAL WEIGHT MODE, press



the **MENU (SELECT)** key.

Select "USB KEY" then press the ENTER key to confirm.



If the message "DT not enabled" doesn't appear, it is necessary to enable it by entering the Configuration Menu (see PASSWORD 19: GENERAL SYSTEM SETTINGS= CONFIGURATION MENU, point 12 Recipe reading from Memory Card).





If the USB key is not connected, the message “Please Wait” appears, followed by the message “USB Error”.

The indicator returns to TOTAL WEIGHT MODE.



EMPTY USB KEY

- 1 If the USB Key is empty, the message “Please, Wait” followed by “card.bin not found” appears.



- 2 The message “Reprogram the USB key by the DTM” appears.



- 3 Next the message “Please, remove the USB key and close the connector” will appear on the screen. After that the indicator creates a file card.bin on the USB key and it goes back to TOTAL WEIGHT MODE.



In this case it is essential to reprogram the USB by the DTM.



USB KEY NOT FORMATTED

- 1 If the USB Key is not formatted for this type of indicator, the message “USB key not Formatted!” appears.



- 2 The message “Format USB Key?” appears.

Press the ENTER key to confirm, otherwise press the RESET key to cancel the operation.



- 3 If you want to format the USB Key, the message “Reprogram the USB key by the DTM” appears.



- 4 Finally, the message “Formatting...Please Wait” appears.



PROGRAMMING DATA TRANSFER FROM PC (DTM)

1 Connect a USB Key to the PC and program it with the DTM Software

2 Connect again the USB key to the indicator. Go to USB KEY Menu.



3 The message "Please, Wait" appears on the screen followed by "No executions to download" or "Downloading Executions on the USB key"



See next paragraph



4 The message "New programming available. COPY NEW DATA?" appears.



- Press the ENTER key in order to replace all the programs (Recipes/ Unloading Programs) saved on the indicator with the new ones saved on the USB key. Copy and paste all the data from the USB key to the memory of the indicator.



- Press the RESET key if you do not want to delete all the programs (Recipes/ Unloading Programs) on the indicator.



5 The indicator returns to TOAL WEIGHT MODE.

SAVING EXECUTION DATA ON THE USB KEY

- 1 After the execution of recipes or unloading programs, it is possible to save the data entering in the "USB KEY" menu.



If the message "Different Database: it is not possible to download the execution data" appears on the screen, it is necessary to reprogram the USB key from the PC/DTM.



If the message "Insufficient Memory" is shown, it is necessary to reprogram the USB key from PC/DTM.

- 2 Press the ENTER key to confirm. The message "Downloading Executions on USB key" appears.





If there aren't any executions to download the message "No Executions to Download" appears.



3 The percentage of the download appears.



Please wait the complete download (100%)



4 The message "Executions downloaded!" appears.



5 Finally the message "Please, remove the USB key and close the connector" will be shown.

The indicator goes back to TOTAL WEIGHT MODE.



SUPPLEMENTARY FUNCTIONS

BATTERY CHECK

By pushing simultaneously **PARTIAL** and **TOTAL** the battery voltage will be visualized.



HOURS and MINUTES: VISUALIZATION



By pushing  key the date and time are visualized.



PROGRAMMING

a) Turn on and when the message



PLEASE WAIT appears push  key and wait until this screen is visualized.

b) By pushing the **PLUS** and **MINUS** keys enter into the hour program menu and set the desired value.



c) Confirm the value with the **ENTER** key (the value will also be seen on the upper display) afterward the indicator will pass on to the next parameters that are:
 Minutes [0 – 59]
 Day [1 – 31]
 Month [1 - 12]
 Year [0-99].





Repeat the operation from point b) for each parameter.

- d) After the confirmation of the year with the ENTER key, the message **PLEASE WAIT** will appear and the indicator will return to **TOTAL WEIGHT**.



PRINT

- a) In order to print the weight keep press the **BLOCK PRINT** key for 3 seconds as indicated by the message on the display. The indicator will return to **TOTAL WEIGHT**.



Verify that the printer is connected to the indicator before performing this operation.



- During the manual function the actual weight value (**TOTAL** and/or **PARTIAL**) can be printed, with date and time, by pressing the **BLOCK PRINT** key.
- During the execution, the **RECIPE** or the **UNLOADING PROGRAMS** used will be automatically printed at the end of the process. At the end of the recipe or unloading program execution this will be automatically printed.
- The **RECIPE** and **UNLOADING PROGRAMS** that are memorized on the weighing system can be printed by pushing the **BLOCK PRINT** key at the end of each program or for a simple visualization of the program that was memorized.
- During the **COMPONENT ACCUMULATION** mode it is possible to print by pressing the **BLOCK KEY** print.

PROGRAM MANAGEMENT

HOW TO ENTER IN THE MAIN MENU TO MODIFY EACH SETTINGS

1

From the modality TOTAL WEIGHT press the  key.

The MAIN MENU contains the following voices:

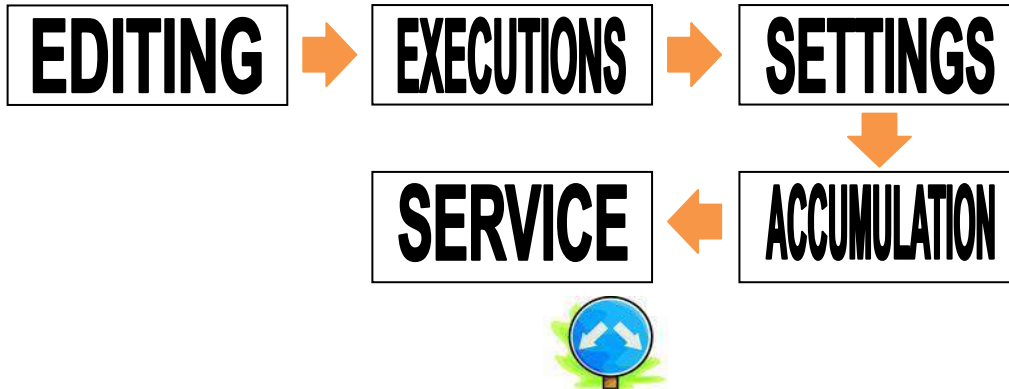

2

Press the  key in order to enter in the submenu.

Press the  key in order to return to TOTAL WEIGHT.

EDITING MENU

HOW TO PROGRAM THE COMPONENTS

1 Enter in the EDITING MENU and select COMPONENTS with the ENTER key.



2 Select the component name that has to be set/modified with the PLUS and MINUS keys from Component n° 1 to n° 99.

Push the ENTER key in order to enter into the setting/modification of the selected component.



3 The blinking letter indicates that it is possible to insert/change the name of the component.

The complete list of characters will appears (editing mould).

Press the ENTER key in order to move in the characters table.

Use the RIGHT, LEFT, PLUS and MINUS keys to select the desired characters.

Press ENTER in order to confirm the character desired.





4  Press the  key in order to choose the type of letter: capital letter, lower case letter, number or sign.



5 Press the PARTIAL key in order to cancel the letter in this way:

- If you are at the beginning of the line, you delete the letter selected;
- If you are from the second letter until the last letter, you delete the previous letter of the letter selected.

6  Press the  key or the ENTER key (for 3 sec) in order to save the name of component.

The message “Changes Saved” appears.



Before to save, press the  key if you wish return back without change the value.



 **dinamica generale®** suggests to set all the components that will be used by inserting the name.

HOW TO PROGRAM THE RECIPES

- 1 Enter in the EDITING MENU and select RECIPES with the ENTER key.



2



If the recipe doesn't exist the message "There are no Recipe" appears.



- 3 Select the recipe number that has to be set with the PLUS and MINUS keys from Recipe 1 to 99.



- 4 If the recipe name doesn't exist (Empty) you could insert it.

Push the ENTER key in order to enter into the setting of the recipe.



If the recipe name already exists you could change it. The message "Modify Name" appears. Press the ENTER key in order to change it.

- 5 The blinking letter indicates that it is possible to insert/change the name of the recipe.

The complete list of characters will appear (editing mould).

Press the ENTER key in order to move in the characters table.

Use the RIGHT, LEFT, PLUS and MINUS keys to select the desired characters.

Press ENTER in order to confirm the character desired.



6



Press the  key in order to choose the type of letter: capital letter, lower case letter, number or sign.



- 7 Press the PARTIAL key in order to cancel the letter in this way:
- If you are at the beginning of the line, you delete the letter selected;
 - If you are from the second letter until the last letter, you delete the previous letter of the letter selected.

8



Press the  key OR the ENTER key (for 3 sec) in order to save the name of recipe and switch to the next step.

9



Before to save, push the RESET key if you do not wish to set the name of the recipe but you want return back and select another Recipe.



- 10** At this point, you can choose if the recipe is by cows or by totals with the PLUS and MINUS keys.

Press the ENTER key in order to confirm your choice.



- a) If you choose RECIPE BY COWS you could pass automatically to mode where you can set the animals by number (see the next paragraph: How to set the animals number).

- b) If you choose RECIPE BY TOTALS you could set the components of the recipe.

Press the ENTER key in order to confirm your choice.

Press the ENTER key in order to go in the COMPONENT LIST.

Select the component with the PLUS and MINUS keys.



Only in modify mode, push the PARTIAL key in order to delete the component. The message "Confirm Deleting?" appears. Confirm with ENTER key.

- 11** Select the component with the ENTER key.



- 12** With the PLUS and MINUS keys set the value of component and confirm it with the ENTER key.



13



Repeat the operation of the points 11 and 12 for the other components but without select the same components (in this case the message Warning appears).



If the total amount of components exceeds the set value in the password 99, after the error message (HHH), the indicator proposes the maximum number of animals for which that limit will not be exceeded.

14



Press the key in order to visualize the Total Programmed.



* The value is only indicative

15 Press the ENTER key in order to continue and set the mixing time (value expressed in minutes).



16 Press the ENTER key in order to confirm and exit by the recipe.



- 17** It is always possible to exit from the programming of the Recipe and return back by pressing the RESET key; in this case the message **SAVE CHANGES?** appears.



- 18** Do you wish to save the settings that were programmed?



YES

If you wish to save the settings that were programmed press the ENTER key. The indicator will visualize the message **CHANGES SAVED** and it will return back.



NO

If you do not want to save the settings previously programmed press the RESET key. The indicator, after visualizing the message **CHANGES LOST**, will return back.



 **dinamica generale®** suggests to set all the recipes that will be used by inserting the name.

HOW TO SET THE ANIMALS NUMBER

- 1 With the PLUS and MINUS keys set the animals number until a maximum of 30000 animals.



Range: 1-30000



- 2 Confirm the set value by pushing ENTER.



- 3 Now, it is possible set the component. Press the ENTER key in order to go in the COMPONENT LIST. Select the component with the PLUS and MINUS keys.



Only in modify mode, push the PARTIAL key in order to delete the component. The message “Confirm Deleting?” appears. Confirm with ENTER key.

- 4 Confirm with the ENTER key.



- 5 Set the value of component with the PLUS and MINUS key.



- 6 Confirm the value with the ENTER key.



7



Repeat the operation of the points 4, 5 and 6 for set the other components.



If the total amount programmed exceeds the set value in the password 99, after the error message (HHH), the indicator recalculates the single values of components and proposes the max value that will coincide with the value of password 99.

8



Press the  key in order to visualize the Total Recipe.



* The value is only indicative

9 Press the ENTER key in order to continue and switch to Total Programmed.



* The value is only indicative

10 Press the ENTER key in order to continue and set the mixing time (value expressed in minutes).



11 Confirm the end of the programming with the ENTER key.

The indicator will return to EDIT RECIPES.



12 It is always possible to exit from the programming of the Recipe and return back by pressing the RESET key; in this case the message SAVE CHANGES? appears.



13 Do you wish to save the settings that were programmed?



YES

NO

If you wish to save the settings that were programmed press the ENTER key. The indicator will visualize the message CHANGES SAVED and it will return back.

If you do not want to save the settings previously programmed press the RESET key. The indicator, after visualizing the message CHANGES LOST, will return back.



HOW TO PROGRAM THE UNLOADING POINTS

- 1 Enter in the EDITING MENU and select UNLOADING POINTS with the ENTER key.



- 2 Select the Unloading Points name that has to be set/modified with the PLUS and MINUS keys from Unloading Points n° 1 to n° 64.

Push the ENTER key to enter into the setting/modification of the selected Unloading Points.

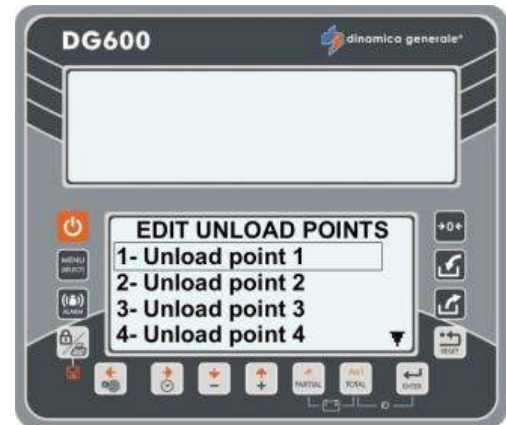

- 3 The blinking letter indicates that it is possible to insert/change the name of the unloading points.

The complete list of characters will appear (editing mould).

Press the ENTER key in order to move in the characters table.

Use the RIGHT, LEFT, PLUS and MINUS keys to select the desired characters.

Press ENTER in order to confirm the character desired.



4



Press the **TOTAL** key in order to choose the type of letter: capital letter, lower case letter, number or sign.

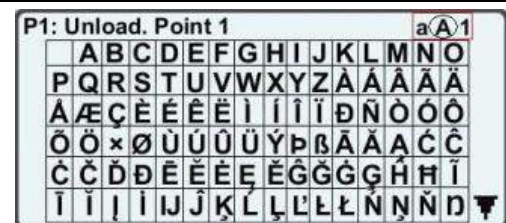

- 5 Press the PARTIAL key in order to cancel the letter in this way:

- If you are at the beginning of the line, you delete the letter selected;
- If you are from the second letter until the last letter, you delete the previous letter of the letter selected.

6



Press the  key OR the ENTER key (for 3 sec) in order to save the name of unloading points.

The message “Changes Saved” appears.



Before to save, press the  key if you wish return back without change the value.



 **dinamica generale®** suggests to set all the Unloading Points that will be used by inserting the name.

[HOW TO PROGRAM THE UNLOADING PROGRAMS](#)

1 Enter in the EDITING MENU and select UNLOADING PROGRAMS with the ENTER key up to 48 positions.



If the Unloading Programs don't exist the message “There are no Unloading Programs” appears.



- 2 Select the Unloading Program name that has to be set with the PLUS and MINUS keys from Unloading Program n° 1 to n°48.



If the Unloading Program name already exists you could change it. The message “Modify Name” appears. Press the ENTER key in order to change it.



Push the PARTIAL key in order to delete the component. The message “Confirm Deleting?” appears. Confirm with ENTER key.

- 3 Push the ENTER key to enter into the setting of the Unloading Programs.



- 4 The blinking letter indicates that it is possible to insert/change the name of the unloading programs.

The complete list of characters will appears (editing mould).

Press the ENTER key in order to move in the characters table.

Use the RIGHT, LEFT, PLUS and MINUS keys to select the desired characters.

Press ENTER in order to confirm the character desired.



5



Press the  key in order to choose the type of letter: capital letter, lower case letter, number or sign.



- 6 Press the PARTIAL key in order to cancel the letter in this way:

- If you are at the beginning of the line, you delete the letter selected;
- If you are from the second letter until the last letter, you delete the previous letter of the letter selected.

7



Press the  key OR the ENTER key (for 3 sec) in order to save the name of the Unloading Program and switch to the next step: Definition of the Unloading Points.

8



Before to save, push the RESET key if you do not wish to set the name of the Unloading Programs but you want return back and select another one.



 **dinamica generale®** suggests to set all the Unloading Programs that will be used by inserting the name.

9 Now, it is possible set the unloading points.

Press the ENTER key in order to go in the UNLOADING POINTS LIST.

With the PLUS and MINUS keys select the Unloading Points by number up to a maximum value of 48.



If in EDIT STRINGS the names of the Unloading Points have been inserted their name will be visualized, if not the wording "Empty" will be seen.



Only in modify mode, push the PARTIAL key in order to delete the component. The message "Confirm Deleting?" appears. Confirm with ENTER key.

10 Confirm by pressing the ENTER key.



11 Set the weight of the unloading point with the PLUS and MINUS keys.

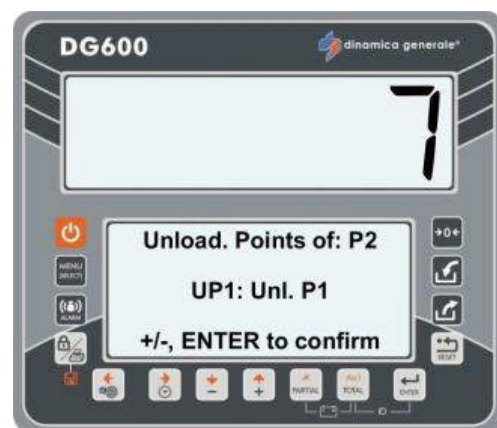

12 Confirm the value by pressing ENTER.



13



Repeat the operation for all the 48 Unloading Points but without select the same value (in this case the message Warning appears).



The maximum limit that can be set for each Unloading Point is 15000 kg/lb. The total amount for each program cannot exceed the value of the password 99, which has a limit of 999999.

If during the programming of an Unloading Point you exceed the maximum limit of the program the indicator will visualize an error message (HHH) afterwards it will propose the weight value for that Unloading Point for which the program limit has not been exceeded.

14 In this case, it is possible:

a) Accept that value and close the program setting the following Unloading Point to zero.

b) Program other Unloading Points, checking the weight of the Unloading Points previously programmed so as to remain inside the total limit of the Unloading Program.

15



Press the  key in order to visualize the Total Programmed.



* The value is only indicative

16 Confirm the end of the programming with the ENTER key.

The indicator will return to EDIT U. PROGRAMS.



17 It is always possible to exit from the programming of the Unloading Point and return to PROGRAM UNLOAD by pressing the RESET key; in this case the message SAVE CHANGES? appears.



18 Do you wish to save the settings that were programmed?



YES

If you wish to save the settings that were programmed press the ENTER key. The indicator will visualize the message CHANGES SAVED and it will return to PROGRAM UNLOAD.



NO

If you do not want to save the settings previously programmed press the RESET key. The indicator, after visualizing the message CHANGES LOST, will return to PROGRAM UNLOAD.



EXECUTIONS MENU

HOW TO CARRY OUT THE EXECUTION OF THE RECIPES

- 1 Enter in the EXECUTIONS MENU and select RECIPE with the ENTER key in order to execute the recipe programmed.



It is possible enter in this menu also by



pressing key from the modality TOTAL WEIGHT.



- 2 Select the recipe that is to be executed with the PLUS and MINUS keys from Recipe 1 to Recipe 99.



3



If the recipe has never been programmed or the total is equal to zero, the message "EMPTY" will appear. If you press ENTER, in this case, the message "WARNING Empty List" will appear.



- 4 Confirm with the ENTER key in order to go into the program execution.



5 On the basis of the programming by cows or by totals it is possible distinguish:



a) If the program is set by COWS, it is possible to modify the number with the PLUS and MINUS keys.



When the modified number of cows is confirmed, the indicator recalculates the weight and checks that the total amount programmed does not exceed the value set in parameters menu, which has the limit of 999999 kg/lb.



If the total amount programmed does exceed the set value in the password 99, after the error message (HHH), the indicator proposes the maximum number of animals for which that limit will not be exceeded.

Confirm with the ENTER key.



On the upper display the WEIGHT TO LOAD is visualized. This value is not changeable.



*The weight value is only indicative.

b) if the recipe is programmed by totals, in other words the number of animals is = 0, the WEIGHT TO LOAD can be modified with the PLUS and MINUS keys.



When the new value is confirmed, the indicator checks that the total amount programmed does not exceed the value set in parameters menu.



If the total amount programmed exceeds the value set in the password 99, after the error message (HHH), the indicator proposes the max value that will coincide with the value of password 99.

6 Confirm with the ENTER key.



7 After the PLEASE WAIT message the first component to load will appear.



8 The passage from one component to the other can take place by pressing the ENTER key or the PLUS key.

If you use the PLUS key in order to switch to the next component without loading anything, the same component is proposed at the end of the loading of all components.

The indicator proposes only the remaining quantity to be loaded and not all the theoretical quantity programmed for that component.

Example: if you have programmed 100 kg but you load 40 kg and press the PLUS key, at the end of the recipe the component is proposed with 60 kg and not 100 kg.

9



Repeat for all the components until the message **TOTAL LOADED** appears.



- 10 Confirm with the **ENTER** key, the Executing Timer will start. It will go on for the time that you have set in editing phase of that recipe.

Example: when you have created the recipe (see the paragraph **HOW TO PROGRAM THE RECIPES**), you have set a mix timer. This value corresponds to the Executing Timer that appear in this step.



- 11 At the end of the minutes the indicator advise you with the acoustic alarm.

- 12 The indicator will return to **TOTAL WEIGHT / RECIPE / MENU** (it depends of the setting in the password 500).



HOW TO CARRY OUT THE EXECUTION OF THE UNLOADING PROGRAM

- 1 Enter in the EXECUTIONS MENU and select UNLOADING PROGRAM with the ENTER key in order to execute the Unloading Program programmed.



It is possible enter in this menu also by



pressing  key from the modality TOTAL WEIGHT.



- 2 Select the Unloading Program that is to be executed with the PLUS and MINUS keys from Unloading Program 1 to Unloading Program 48.

If the Unloading Program has never been programmed or the total is equal to zero, the message "EMPTY" will appear. If you press ENTER, in this case, the message "WARNING Empty List" will appear.



- 3 Confirm with the ENTER key to go into the Unloading Program execution.



- 4 Press the PLUS and MINUS keys in order to modify the weight to Unload.

In this situation is also possible to press the TOTAL key in order to set the weight actually loaded on the wagon; the system will automatically update the total weight to be unloaded with the value actually loaded on the wagon.



When the modified Weight to Unload is confirmed, the indicator recalculates the weight to unload related to each Unloading Program.

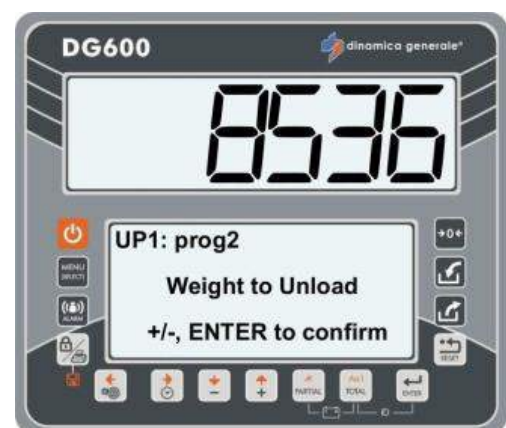

- 5 Confirm with the ENTER key.



6 After the message PLEASE WAIT the first Unloading Program will appear.

7 The Unloading Program has to be carried out until the weight reaches zero. The passage from one Unloading Program to the other is automatic if in parameters menu AUTO ADVANCE = 1 has been selected. If not then you have to press ENTER to pass from one Unloading Program to the other memorizing the unloaded value.



8



Repeat for all the Unloading Programs until the message TOTAL UNLOADED is visualized.



9 When the Unloading Program is complete the indicator return to TOTAL WEIGHT.



At the end of the execution, every operation will be saved if defined in the pwd 888.

NOTE:

HOW TO BLOCK THE WEIGHING

During the Unloading Program execution it is possible to suspend the weighing by



pushing the key and resume afterwards by pushing the same key. In the moment that this operation resumes the indicator recalls the weight that was present at the time of the block.



dinamica generale® suggests to always use this function when the mixer is moving.



MANUAL MANAGEMENT OF THE RECIPE/UNLOADING PROGRAMS WITH THE ENTER KEY

It is also possible to pass from one execution to the other by pressing the



key; in this case the actual unloaded value will be memorized that can be the total of the amount programmed or only a part.

*The value is only indicative.



MANAGEMENT OF THE RECIPE/ UNLOADING PROGRAMS WITH PLUS AND MINUS KEYS

When you pass from one execution to the other with the PLUS and MINUS keys, no weighing will be memorized.



If the PLUS key is pressed while setting the last execution the indicator considers the execution concluded and will return to TOTAL WEIGHT.

HOW TO VISUALIZE THE TOTAL DURING THE EXECUTION

During an execution it is possible to visualize the total weight loading during

the loading phase with the



key.



The TOTAL WEIGHT condition in the case of an unloading coincides with the total weight unloaded at that moment.

In order to return to the unloading

execution press



again.



HOW TO RETRIEVE THE EXECUTION FOLLOWING THE TURNING OFF OF THE INDICATOR

If during an execution the indicator is turned off for power reasons or in any other case the load can be retrieved. Once the indicator is turned on the message RESTORE LOAD/UNLOAD? will be visualized on the lower display.

At this point it is possible to:



a) reset the execution that was interrupted



by pressing the ENTER key.

b) ignore the reset of the execution therefore losing all the data by pressing



the RESET key. The indicator will return to TOTAL WEIGHT.



RESTORE MODE FOR THE PROGRAMMED VALUE

During the execution is possible to restore the programmed weight for the single components, pressing for 5 sec the key



* The weight value is only indicative.



SETTINGS MENU

PARAMETERS SUBMENU



All the parameters that you setting in this menu are the same of the PASSWORD 19 SEQUENCE OF THE SETTINGS = SETTINGS MENU.



ENGLISH

CONTRAST SUBMENU

From the SETTINGS MENU:

- a) Select the CONTRAST submenu and confirm with the ENTER key;
- b) Set the value with the PLUS and MINUS keys;
- c) Press ENTER key in order to confirm the value.



ACCUMULATION MENU

From the MAIN MENU, enter in the ACCUMULATION MENU with the ENTER key in order to manage the accumulations.



COMPONENT ACCUMULATION

It allows to visualize the list of each components with the relative weight.



UNLOADING POINTS ACCUMULATION

It allows to visualize the list of each unloading points with the relative weight.

CLEAR COMPONENT ACCUMULATION

It allows to delete all data of component accumulation. Once press the ENTER key, the messages “Memory Deleted” and “No Accumulation” appears.



ENGLISH

CLEAR UNLOADING POINTS ACCUMULATION

It allows to delete all data of unloading point accumulation. Once press the ENTER key, the messages “Memory Deleted” and “No Accumulation” appears.



Press the RESET key if you don't wish clear the datas.

SERVICE MENU

- 1 From the MAIN MENU, enter in the SERVICE MENU with the ENTER key in order to check the status of system.



DIAGNOSTIC SUBMENU

It allows checking all the functioning hardware of the indicator (display, combo, keyboard, date & time etc.)

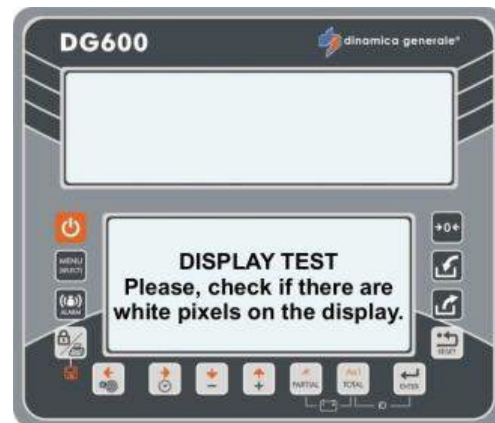

NUMBER WORKING HOURS

It allows to visualize the last reset:

- Date & time of last reset;
- Total number of hours that the indicator has been worked;
- Total number of hours relative to the executions effected.



NUMBER OF OVERLOADS

It allows visualizing the number of overloads with date, hour and value of overload.



Press the RESET key in order to return to the main menu.

SYMBOLS

CONVENZIONAL SYMBOLS

This manual adopts some conventional symbols in order to guide the user through important instructions and warnings regarding especially the programming of the system's parameters and therefore it's correct functioning. Please pay attention to the following graphical messages:



Indicates explanatory and added information.



Recommends the maximum attention.



Signals an operation that can be repeated various times.



Highlights a double operative option.



Advises of suggestions to carry out.



Signals that the weight value on the display is only indicative since it is only an example or it advises the presence of notes.

OPTIONAL ACCESSORIES

PRINTER

It records on a ticket the information about the weights loaded or about the recipes that have been saved on the indicator (depending from the dinamica generale microcomputer), including the option to personalize the ticket. Possibility to print the strings in the languages that are available on the indicator.

- Possibility to define the customer's headline, name, address, company title etc.
- Low cost maintenance.
- Print module with thermal impact.
- In accordance with EEC directives.
- It is connectable to every dinamica generale microcomputer.
- During manual working, it is possible to print the current weight value (TOTAL and/or PARTIAL) with date and time by pressing the PRINT key.
- During the execution, the RECIPE or the UNLOADING PROGRAMS are automatically printed at the end of the process.
- In order to advance of the paper by hand, press the Feed key on the printer panel.

WINET™ MODEM

Compatible modem with all dinamica generale accessories and indicators, that is able to manage a wireless network between several devices without any interference issues.

- Best control of the equipment with maximum profit and without cable.
- Possibility to use many accessories connected to the indicator through wire or wireless.
- Only with one radio control the operator can manage several indicators and accessories at a time.
- Working range 25 meters x 360°.
- Improved organization for big companies in which you are working with more than one vehicle.

CAB DISPLAY

Supplementary display with little dimensions, suggested using into the cabin of the self propelled machine or with WIRELESS Connection on any kind of machine used for the mixer load.

- Weight reading up to 99.999 Kg / Pounds.
- Operating temperature: - 30 / + 65 °C (-22 / +150°F).
- Dimensions 160 x 80 x 60 mm (6 x 3 x 2 inches).
- IP65 protection.
- Red "diodes LED" display high efficiency 25 mm high.
- Display visibility: more than 10 meters (30 feet).
- Simple and direct connection to all indicators dinamica generale®.
- The display can be connected by wire or by radiofrequency (WINET™).
- Possibility of a series connection of more displays.

WEIGHT REPEATER

Weight Repeater Display for a perfect visibility in any position, with the possibility also of WIRELESS Connection, and series connection.

- Weight reading up to 99.999 Kg / Pounds.
- Operating temperature: - 30 / + 65 °C (-22 / +150°F).
- Dimensions 275 x 124 x 87 mm (10 x 4 x 3 inches).
- IP68 protection.
- Red "diodes LED" display high efficiency 60 mm high.
- Display visibility over 30 meters (100 feet).
- Simple and direct connection to all indicators dinamica generale®.
- The display can be connected by wire or by radiofrequency (WINET™).
- Possibility of a series connection of more displays.

XL DISPLAY

Very large led display used for the remote weight visualization and the operator messages. It is especially indicated for very large machines to allow the operator a constant control of weight as well as component name also at high distance.

- Weight reading up to 999.999 Kg / Pounds.
- Operating temperature: - 30 / + 65 °C (-22 / +150°F).
- Dimensions: 870 x 220 x 120 mm (34 x 8 x 4 inches).
- Red, Green and Yellow "diodes LED" display.
- IP65 protection.
- Display view: over 50 m (165 feet).
- Simple and direct connection to all microcomputers dinamica generale with the WiNET™ interface.
- Metal watertight case protected against radio frequency noises.
- Multilanguage management.
- Graphic bar.

EXTRA DISPLAY

Led display used for the remote weight visualization and the operator messages. It is especially indicated to allow the operator a constant control of weight as well as component name also at high distance.

- Red, Green and Yellow "diodes LED" display.
- Metal watertight case protected against radio frequency noises.
- Simple and direct connection to all microcomputers dinamica generale with the WiNET™ interface.
- Connection to the indicator by wire.
- Number of display is unlimited and can be chosen based on specific customer request.
- The display can be connected in a multipoint link by cable serial connection.
- Multilanguage management.
- Graphic bar.

Dina TEL 3

Remote Control with innovative design, able to control the indicator up to 25 meters. Thanks its LCD display with intuitive softkeys, back light on the keyboard and fixing support, it is essential device to remote indicator on the loader cabin.

- Operating temperature: - 30 / + 65 °C (-22 / +150°F).
- Dimensions: 190 x 160 x 70 mm.
- IP68 protection.
- Working range 25 meters (82 feet) x 360°(Available also version with range up to 100 meters (330 feet))
- Power supply: 9,5 – 32 Vdc
- Unique remote control for all the dinamica generale applications.
- Directly compatible with all indicators (no Top Scale).

DTM™

Data exchange Computer-Indicator using Memory Card

DTM is a feeding management software developed with farmers in order to satisfy needs of farms. DTM is the evolution of a feeding software management in a professional, user friendly and integrated solution for farmers. All farm activities are controlled with a single innovative tool. An easy way to monitor and decrease costs and increase profits.

- Multi Language Interface and Setup, Contextual Help Online, Sw Upgrade via Internet.
- Ingredient definition with costs traceability, Diet/Recipe definition and feed distribution.
- Automatic Dry Matter adjustment of component (not available on every version of DTM).
- Programming of Components, Recipes, Groups, Unload Programs/Batch.
- Loading/Unloading History and detailed reports (not available on every version of DTM).
- Stock and costs management (not available on every version of DTM).
- Refused and Operators management (not available on every version of DTM).
- Historical data and detailed reports on NIR Analysis made by dg precisionFEEDING and AgriNIR™ (not available on every version of DTM).

EASY CONTROL 2

Radio Frequency communication (WiNET™)

Remote control in order to command the indicator all the way up to 25 meters (82 feet). With the WiNET™ Modem interface, the remote control can be used with all dinamica generale wireless accessories without any interference: all devices talk together in the same network.

- IP66 protection
- Working range 25 meters (82 feet) x 360°
- Battery type AA 1,5 Volt.
- Autonomy 120 days (normal function).
- Possibility to use EASY CONTROL 2 with other accessories connected to the indicator by wire or wireless with WINET™
- New features for zeroing and ID customer set.
- New ergonomic design for a better integration user hand – product, with soft rubber handling surface
- Backside battery house protected with a sliding cover, for a improved maintenance of the product (battery change)
- Available also version *Easy Control 2 PtoP* (no other wireless accessory can be used with this version)

WEIGHT TRANSMITTER 2

Device for the use of the weighing system in the industrial process lines.

This module is connected to the indicators in order to transform the weight value in an analogical signal 4-20 mA, or 0-10 V for the communication between the weighing system and the industrial devices such as inverter, PLC, etc.

- Analogic Output Voltage: 0 - 5 Vdc; 0 - 10 Vdc.
- Analogic Output Current: 0 - 20 mA; 4 - 20 mA.
- Power Supply: 10 - 32 Vdc (Voltage Output) and 20 - 32 Vdc (Current Output).
- Connection module PROFIBUS to DG-WT 2.
- Connection module PROFIBUS to PLC.
- Directly compatible with all indicators.

CAN BUS Connector

The J1939 protocol available on the CAN BUS output is deeply described in a specific document, not part of this manual. Please contact the Dinamica Generale Customer Service or R&D office for more information.

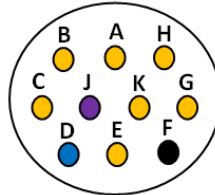

Cable color	Signal	HI-TECH Connector
Blue	CAN H	D
Purple	CAN L	J
Black	GND	F

Without CAN BUS terminator.

Activation of communication protocol J1939

You can enable this protocol through the password 689 but it is available only for some part number. It offers the possibility to send the strings relating to the recipe name, components, unloading programs and unloading points.

Below the parameters that you can manage:

- **CANBus ADDRESS (0-255):**
value relating to the protocol address that corresponds to the device connected.
- **TRANSMISSION FREQUENCY / ENABLE (Disabled-100ms-200ms...1000ms):**
value of transmission frequency.
- **BROADCAST TYPE:**
 - 0 - All PGNs in order to send all the data
 - 1 - Weight Status in order to send only the weight value
 - 2 - Exec. Data in order to send the components name, recipe etc.

CAN BUS CABLE CONNECTIONS:

BLUE : CAN H



VIOLET : CAN L

BLACK : GROUND

Inside the indicator there isn't the CAN BUS termination 120 ohm resistance.

SEARCHING FOR FAULTS

MOTION ALARM		
DISPLAY	CAUSE	SOLUTION
<p>DG600</p> 	<p>Cause1 The signal that comes from the sensors presents sudden and important weight changes.</p> <p>Cause2 A cable or load cell is not working correctly.</p>	<p>Solution1: Do the TARE.</p>
		<p>Solution2: Carry out the calibration with password 12 and then do the TARE.</p>
		<p>Solution3: Carry out the control procedure described below.</p>
DOES NOT TURN ON		
DISPLAY	CAUSE	SOLUTION
<p>OFF</p>	<p>Power does not reach the microcomputer.</p>	<p>Solution1: Carefully verify the connection cable that goes from the microcomputer to the power supply.</p>
		<p>Solution2: Verify the efficiency of the power supply (Minimum 9 Volts / 0.5 A).</p>
		<p>Solution3: Send the microcomputer to dinamica generale® or to the nearest service center</p>

OVERRANGE ALARM		
DISPLAY	CAUSE	SOLUTION
<p>DG600</p> 	<p>Cause1</p> <p>The microcomputer is not able to read the signal from the load cells: the connection cable is not working correctly.</p>	<p>Solution1:</p> <p>Do the TARE.</p>
	<p>Cause2</p> <p>A cable or a load cell is not working correctly.</p>	<p>Solution2:</p> <p>Carry out the calibration with password 12 and then do the TARE.</p>
	<p>Cause3</p> <p>The signal that comes from the sensors is out of the valid "RANGE" (see password 99).</p>	<p>Solution3:</p> <p>Carry out the control procedure described below.</p>
LOW BATTERY ALARM		
DISPLAY	CAUSE	SOLUTION
<p>DG600</p> 	<p>The power supply of the indicator goes below the fixed value.</p>	<p>Solution1:</p> <p>Check the correct function of the battery.</p>
		<p>Solution2:</p> <p>Check the CABLES that send the power from the BATTERY to the INDICATOR.</p>
UNSTABLE WEIGHT		
DISPLAY	CAUSE	SOLUTION
<p>The weight continues to go up and down by tens or hundreds kg</p>	<p>The signal that comes from the sensor is disturbed: a cable or a load cell does not work correctly.</p>	<p>Carry out the control procedure described below.</p>

CHECK THE DAMAGED COMPONENTS

DEFINE THE TESTING PROCEDURE:

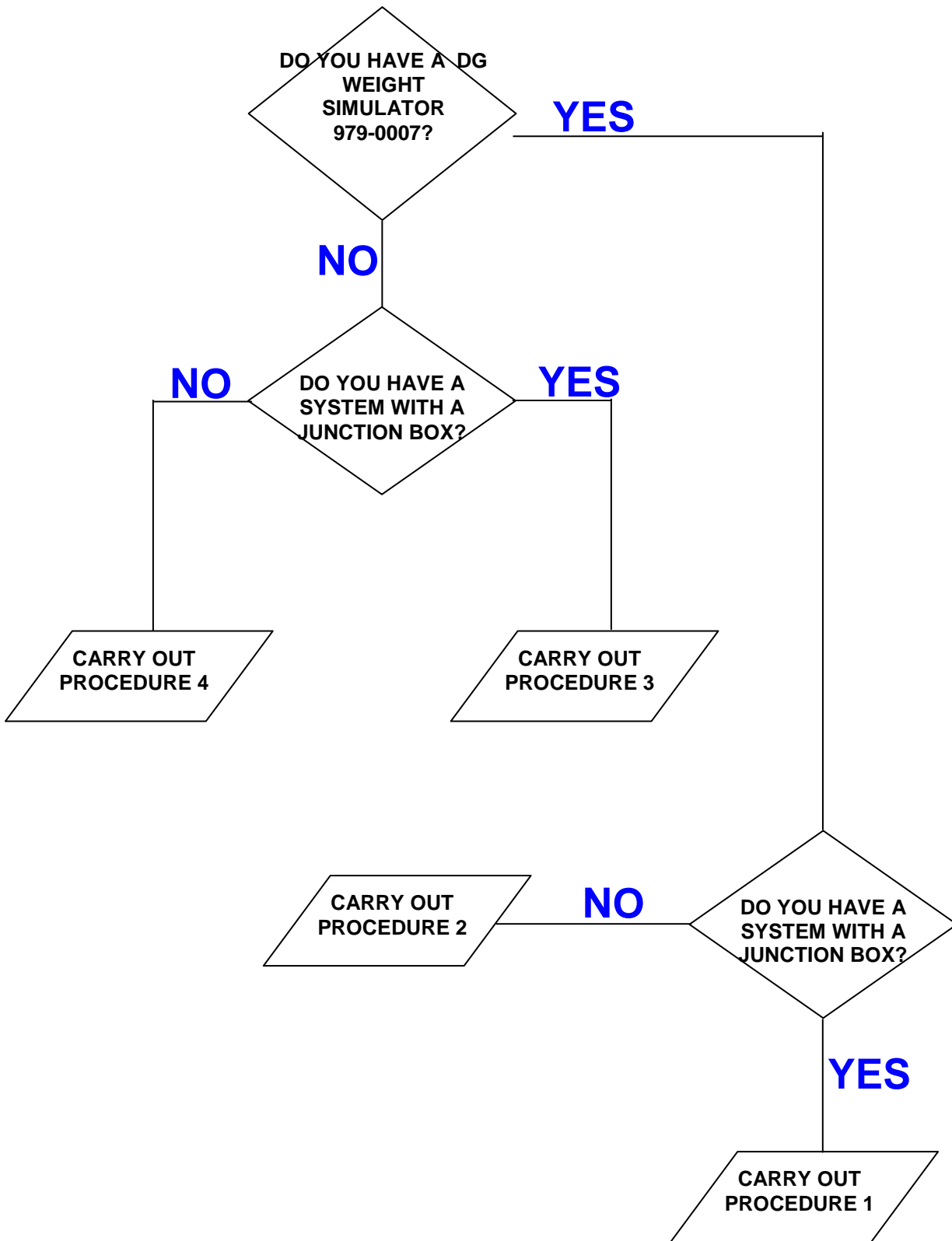

PROCEDURE 1**Ref. YES/YES**Check that the scale is working correctly

- a) Turn off the indicator.
- b) Disconnect the sensor cables that are found from the indicator to the junction box.
- c) Connect the WEIGHT SIMULATOR (979-0007), with the switch on the "Var" (variable) position, to the SENSOR connector of the indicator.
- d) Turn on the indicator.
- e) Do the TARE (for the execution see the indicator user's manual).
- f) The indicator has to be stable visualizing "0" kg.
- g) Check that the scale is working correctly by turning the WEIGHT SIMULATOR (clock wise the weight increases, counter clock wise it decreases).

RESULT	CAUSE	ACTION
Zero is stable and is working correctly	The indicator is NOT damaged	Proceed with the following tests
Zero is not stable or is not working correctly	The indicator is damaged.	Contact the service center

Check the correct functioning of the SENSOR CABLE and of the JUNCTION BOX

- a) Turn off the indicator.
- b) Open the JUNCTION BOX.
- c) Disconnect the sensors leaving only connected the cable that goes to the indicator (SENSOR CABLE).
- d) On the place of one of the sensors connect the WEIGHT SIMULATOR (979-0007) with the appropriate adapter.
- e) Turn on the indicator.
- f) Do the TARE (for the execution see the indicator user's manual).
- g) The indicator has to be stable visualizing "0" kg.
- h) Check that the scale is working correctly by turning the WEIGHT SIMULATOR (clock wise the weight increases, counter clock wise it decreases).

REPEAT THE TEST BY CONNECTING THE WEIGHT SIMULATOR TO EACH SENSOR.

RESULT	CAUSE	ACTION
Zero is stable and is working correctly	Sensor cable and junction box are NOT damaged	Proceed with the following tests
Functioning is not correct only in a few connectors of the junction box	The junction box is damaged or is wet	Try to dry out the junction box and repeat the test, if the result is always the same change the junction box.
Zero is not stable or functioning is not correct in all of the connectors of the junction box	The sensor cable is damaged	Substitute the sensor cable

Check the functioning of the SENSORS

- a) Open the junction box.
- b) Leave only a sensor and the cable (SENSOR CABLE) that goes to the indicator connected.
- c) Do the TARE (for the execution see the indicator user's manual).
- d) The indicator has to be stable visualizing "0" kg.
- e) Check the correct functioning by loading some weight on the sensor that is connected (the weight that is loaded does not have to be correct but it has to be stable).

REPEAT THE TEST BY CONNECTING ONE AT A TIME EACH SENSOR.

RESULT	CAUSE	ACTION
Zero and stable weight	The sensor is NOT damaged	Proceed with the following sensor
Zero and non stable weight	The sensor is damaged	Contact the service center

PROCEDURE 2

Ref. YES/NO

Check the functioning of the indicator

- a) Turn off the indicator.
- b) Disconnect all of the sensors.
- c) Connect the WEIGHT SIMULATOR with the switch on the "Var" (variable) position and one of the sensor connectors of the indicator.
- d) Turn on the indicator.
- e) Do the TARE (for the execution see the indicator user's manual).
- f) The indicator has to be stable visualizing "0" kg.
- g) Check the correct functioning by loading some weight on the sensor that is connected (the weight that is loaded does not have to be correct but it has to be stable).

REPEAT THE TEST BY CONNECTING THE WEIGHT SIMULATOR IN THE PLACE OF EACH SENSOR.

RESULT	CAUSE	ACTION
Zero is stable and the functioning is correct in all the sensors	The indicator is NOT damaged	Proceed with the following tests
Zero is not stable or the functioning is not correct in one or more connectors	The indicator is damaged	Contact the service center

Check the functioning of the SENSORS

- a) Turn off the indicator.
- b) Leave connected only one sensor to the indicator.
- c) Turn on the indicator.
- d) Do the TARE (for the execution see the indicator user's manual).
- e) The indicator has to be stable visualizing "0" kg.
- f) Check the correct functioning by putting some weight on the sensor that is connected (the weight that is loaded does not have to be correct but it has to be stable).

REPEAT THE TEST BY CONNECTING ONE AT A TIME EACH SENSOR.

RESULT	CAUSE	ACTION
Zero and weight are stable	The sensor is NOT damaged	Proceed with the following sensor
Zero and weight are not stable	The sensor is damaged	Proceed with the following sensor. Contact the service center

PROCEDURE 3**Ref. NO / YES**Check the functioning of the SYSTEM and of the SENSORS

- a) Turn off the indicator.
- b) Open the JUNCTION BOX.
- c) Leave connected only one sensor and the cable that goes to the indicator (SENSOR CABLE).
- d) Turn on the indicator.
- e) Do the TARE (for the execution see the indicator user's manual).
- f) The indicator has to be stable visualizing "0" kg.
- g) Check the correct functioning by putting some weight on the sensor that is connected (the weight that is loaded does not have to be correct but it has to be stable).

REPEAT THE TEST BY CONNECTING ONE AT A TIME EACH SENSOR IN THEIR ORIGINAL POSITIONS.

RESULT	CAUSE	ACTION
Zero and weight are stable in all the connectors	The system works correctly	Connect everything and retry as per in normal use
Zero and weight are NOT stable only on a few connectors in the junction box	The box or the sensors connected to those connectors are damaged	Connect a functioning sensor on the "critical" connector, repeat the test and verify the following 2 lines
Even with a new sensor the zero and weight are NOT stable	The junction box is damaged	Substitute the junction box and repeat the test
With a new sensor the zero and weight are stable	The sensor that was previously connected is damaged	Contact the service center
Zero and weight are NOT stable on all the connectors in the junction box	The sensor cable or indicator is damaged	Substitute the sensor cable repeat the test and verify the following line
Zero and weight are still NOT stable	The indicator is damaged	Contact the service center

PROCEDURE 4**Ref. NO / NO**Verify the functioning of the SYSTEM and of the SENSORS

- a) Turn off the indicator.
- b) Leave connected only one sensor to the indicator.
- c) Turn on the indicator.
- d) Do the TARE (for the execution see the indicator user's manual).
- e) The indicator has to be stable visualizing "0" kg.
- f) Check the correct functioning by putting some weight on the sensor that is connected (the weight that is loaded does not have to be correct but it has to be stable).

REPEAT THE TEST BY CONNECTING ONE AT A TIME EACH SINGLE SENSOR TO THE SAME CONNECTOR.

RESULT	CAUSE	ACTION
Zero and weight of one sensor are NOT stable	The sensor is damaged	Contact the service center
Zero and weight of all the sensors on the same connector are NOT stable	The indicator is damaged	Contact the service center
Zero and weight are stable with all the sensors on the same connector	None	Repeat the test with another connector of the indicator
Zero and weight are stable with all the sensors in all the connectors	The system works correctly	Connect everything and retry as in normal use

ERROR CODES

List of errors that could be visualized. In order to unblock the indicator, the operator can push any button.

Error Code	Description
Error 1	Broken button: a button on the keyboard is broken and therefore results in being unusable
Error 2	The data regarding the loading executions has NOT been saved on the Data Transfer (memory card) but has been saved on the internal memory. <u>Next time the scale is turned on it will try to memorize them on the card.</u>
Error 3	The data regarding the loading executions has NOT been saved neither on the Data Transfer nor on the internal memory. <u>There is no way to recuperate the loading executions therefore the data will be lost.</u>
Error 4	The data regarding the execution of a <u>loading recipe</u> results in being corrupt before being saved on the Data Transfer. <u>Nothing will be saved on the Data Transfer and therefore the data will be lost definitively.</u>
Error 5	The data regarding the execution of a <u>loading recipe</u> has NOT been saved on the Data Transfer because the memory is not sufficient. The data has been in any case saved on the internal memory. <u>The operator can, when turning on the indicator the next time, recuperate the data by using a card with sufficient memory.</u>
Error 6	The data regarding the execution of a <u>loading recipe</u> has NOT been saved on the Data Transfer BUT have been saved on the internal memory. <u>Next time the indicator is turned on it will try to memorize them on the card.</u>

Error 7	The data regarding the execution of the <u>loading recipe</u> has NOT been saved neither on the Data Transfer nor on the internal memory. <u>There is no way to recuperate the data regarding this execution.</u>
Error 8	The data regarding the execution of an <u>unloading recipe</u> results in being corrupt before being saved on the Data Transfer. <u>Nothing will be saved on the Data Transfer and therefore the data will be lost definitively.</u>
Error 9	The data regarding the execution of an <u>unloading program</u> has NOT been saved on the Data Transfer BUT have been saved on the internal memory. <u>Next time the indicator is turned on it will try to memorize them on the card.</u>
Error 10	The data regarding the execution of an <u>unloading program</u> has NOT been saved neither on the Data Transfer nor on the internal memory. <u>There is no way to recuperate the data regarding this execution.</u>
Error 11	The data regarding the execution of an <u>unloading program</u> results in being corrupt before being saved on the Data Transfer. <u>Nothing will be saved on the Data Transfer and therefore the data will be lost definitively.</u>
Error 12	The data regarding the execution of an <u>unloading program</u> has NOT been saved on the Data Transfer because the memory is not sufficient. The data has been in any case saved on the internal memory. <u>The operator can, when turning on the indicator the next time, recuperate the data by using a card with sufficient memory.</u>
Error 13	The data regarding the execution of a <u>manual weighing</u> has NOT been saved on the Data Transfer BUT have been saved on the internal memory. <u>Next time the indicator is turned on it will try to memorize them on the card.</u>
Error 14	The data regarding the execution of a <u>manual weighing</u> has NOT been saved neither on the Data Transfer nor on the internal memory. <u>There is no way to recuperate the data regarding this execution.</u>
Error 15	The data regarding the execution of a <u>manual weighing</u> results in being corrupt before being saved on the Data Transfer. <u>Nothing will be saved on the Data Transfer and therefore the data will be lost definitively.</u>
Error 16	The data regarding the execution of a <u>manual weighing</u> has NOT been saved on the Data Transfer because the memory is not sufficient. The data has been in any case saved on the internal memory. <u>The operator can, when turning on the indicator the next time, recuperate the data by using a card with sufficient memory.</u>
Error 17	At the turning on of the indicator the recovery of the data regarding an execution saved on the internal memory has failed
Error 18	The operator tried to carry out "Restore Load" after the turning on and off of the indicator during a loading execution, but the block presents non valid data. <u>The operator can in any case go ahead with the interrupted execution but it will not be saved on the card.</u>
Error 19	The operator tried to carry out "Restore Load" after the turning on and off of the indicator during an unloading execution but the block present non valid data. <u>The operator can in any case go ahead with the interrupted execution but it will not be saved on the card.</u>
CLOCK ERROR !	During the initialization phase the reading of the clock failed. The clock battery could be drained. The indicator, a part from the message on the LCD display, will activate the siren. After substituting the battery the right time has to be set and afterwards turn off and back on the indicator. Once the indicator has been turned back on the error message will not be seen.

**DICHIARAZIONE DI CONFORMITA' - DECLARATION OF CONFORMITY
KONFORMITÄTSERKLÄRUNG - DÉCLARATION DE CONFORMITÉ - DECLARACION DE
CONFORMIDAD - ДЕКЛАРАЦИЯ О СООТВЕТСТВИИ**

Nr 26/16

- IT** Il sottoscritto, designato a legale rappresentante della Dinamica Generale s.p.a. , via Mondadori 15, Poggio Rusco (MN) - Italy, dichiara che i prodotti sottoelencati:
- EN** The undersigned, an authorised officer of Dinamica Generale s.p.a. , via Mondadori 15, Poggio Rusco (MN) - Italy, hereby declares that the products listed hereunder:
- D** Der Unterzeichner, rechtlicher Vertreter der Dinamica Generale s.p.a. , via Mondadori 15, Poggio Rusco (MN) – Italy, erklärt, daß die nachstehend beschriebenen Produkte:
- FR** Je soussigné, représentant légal désigné de Dinamica Generale s.p.a. , via Mondadori 15, Poggio Rusco (MN) - Italy, déclare que les produits énumérés ci-après:
- ES** El suscrito, nombrado representante legal de la Dinamica Generale s.p.a. , via Mondadori 15, Poggio Rusco (MN) - Italy, declara que los productos indicatos a continuación:
- RU** Нижеподписавшийся, являющийся законным представителем компании Dinamica Generale s.p.a., расположенной по адресу via Mondadori 15, Poggio Rusco (MN) – Italy, заявляет, что продукция ниже

DG600

- IT** Sono conformi a quanto prescritto dalle seguenti direttive:
- EN** Are in compliance with the following directives:
- D** Mit den Vorschriften konform sind, die in den folgenden Richtlinien:
- FR** Sont conformes aux prescriptions des directives suivantes:
- ES** Respetan las prescripciones contenidas en las siguientes directivas:
- RU** Соответствует требованиям следующих директив:

2014/30/EU

- IT** E dalle seguenti norme:
- EN** And with the following standards:
- D** Und Normen stehen:
- FR** Et aux normes ci-apres:
- ES** Y en las siguientes normas:
- RU** И следующих стандартов:

Main Standards:
EN ISO 14982
EN 61326-1 (2013-01)
EN 61326-2-3 (2013-01)

Test Methods:
EN 55011 (2009-11) + A1 (2010)
EN 61000-4-2 (2009-03)
EN 61000-4-3 (2006-05) + A1 (2008) + A2 (2010)
EN 61000-4-4 (2012-11)
EN 61000-4-5:2014-08

- IT** E, in applicazione a quanto previsto dalle direttive citate, sono stati dotati di marcatura CE ed é stato predisposto un adeguato fascicolo tecnico presso la ns. sede.
- EN** And, pursuant of the above-mentioned directives, the CE mark has been applied. Furthermore, adequate technical file has been prepared and is available from our offices.
- D** Und daß sie in Übereinstimmung mit den Vorschriften der obengenannten Richtlinien mit dem CE-Zeichen versehen sind und daß dafür ein angemessenes technisches Heft erstellt wurde, das bei uns in der Firma zur Verfügung steht.
- FR** En application des directives citées, ils portent la marque CE et un dossier technique est déposé auprès de notre siège.
- ES** Y, conforme con lo previsto en las citadas directivas, han recibido la marca CE. Existe asimismo un específico prospecto técnico relativo disponible en nuestra sede.
- RU** И, в исполнении данных директив, был нанесен знак CE и соответствующее техническое досье было заведено в нашем офисе.

Poggio Rusco, 20/04/2016

Andrea GHIRALDI

WARNINGS



The power cable has to be connected directly to the battery or to a regulated power source.

If this is not the case DG does not respond to any eventual damage to the microcomputer.



Disconnect the power cable from the microcomputer when the battery of the machine is being charged.

If this is not the case DG does not respond to any eventual damage to the microcomputer.



Disconnect all the cables from the microcomputer before performing welding operations on the machine.

If this is not the case DG does not respond to any eventual damage to the microcomputer.



In order to have a correct functioning, check that the battery always has a tension level above 10,5 Volt.



This marking on the product or on its packaging illustrates that this product may not be disposed of with normal household waste.

You are responsible for disposal of this equipment in a correct way and in according to local regulations.



Before clearing the mixer with a high pressure washer protect the device from possible water seepage. Furthermore be very careful to not expose the sensors, junction box, acoustic alarm, cables and other eventual optional accessories to direct water jets.



If the equipment needs to be cleaned, use a soft, damp, lint-free cloth. Never use sprays, solvents, abrasives, or sharp or pointed objects that could damage the indicator.

GUARANTEE

The supplier guarantees, for 24 months from the delivery date, the good quality of the materials used, the excellent construction and the steady functioning of the instrument that has been manufactured and that bears the trademark or the production serial number. During the guarantee period the supplier undertakes to repair or replace, free supplier's head office, faulty parts due to poor materials or faulty construction, provided that such parts are delivered free port supplier's head office.

Shortcomings and defects due to the incorrect use of instruments, inadequate maintenance, changes carried out without the supplier's approval and normal wear are not included in this guarantee.

Liability and compensations by the supplier due to direct or indirect damages to persons, objects or production, even as a consequence of faulty functioning of the supplied instruments or of material or construction defects, are not included in this guarantee.

NOTE:

dinamica generale® has the faculty to modify the content of this user's manual due to hardware and software implementations in order to improve the products and therefore guarantee the best service to their users.

Congratulations Dear User!

You have chosen a **dinamica generale®** product, a leading company in the development and production of electronic weighing systems, automation systems and NIR solutions. These systems bring a high technological level in every field of application such as zoo technical, feeding, industrial and biomedical. Year by year the international market recognizes the quality, experience, reliability and most of all the innovative technology, as a part of a highly developed and innovative know how. These are the pillars of our work and according to these beliefs we are at your service, providing you with a simple as well as new, precise and professional product, which is going to make your job easier for many years. This user's manual intends to take you through the different performances of the weighing system in the easiest way possible and to show you some new functions as well. **dinamica generale®** did not forget to provide you with even the most basic information: the configuration, the use of different accessories at your disposal, the service of "searching for faults" and the equipment's safety rules, in order to guarantee to our customers more and more support and technical assistance for years to come.

Now there is nothing left for us to do but wish you a work well done!

The **dinamica generale®** team



CONTACTS

GENERAL INFORMATION
info@dinamicagenerale.com

SALES DEPARTMENT
sales@dinamicagenerale.com

CUSTOMER SERVICE
support@dinamicagenerale.com

ASSISTANCE



Technical assistance 24 hours a day, 365 days a year.

QUALITY & CERTIFICATIONS

For **dinamica generale**, sustainability means integrating long term economic, environmental and social dimensions into the way we operate our business according to the:



ISO 9001:2008



ISO 14001:2004



ISO 13485:2012



Dinamica Generale® uses PEFC paper for printing manuals and catalogues.

dinamica generale S.p.A.
via Mondadori, 15
46025 Poggio Rusco (MN) - Italy
tel +39 0386.52134
fax +39 0386.51523

www.dinamicagenerale.com
info@dinamicagenerale.com

